

ARCHITECTURAL LIGHTING MADE IN ITALY

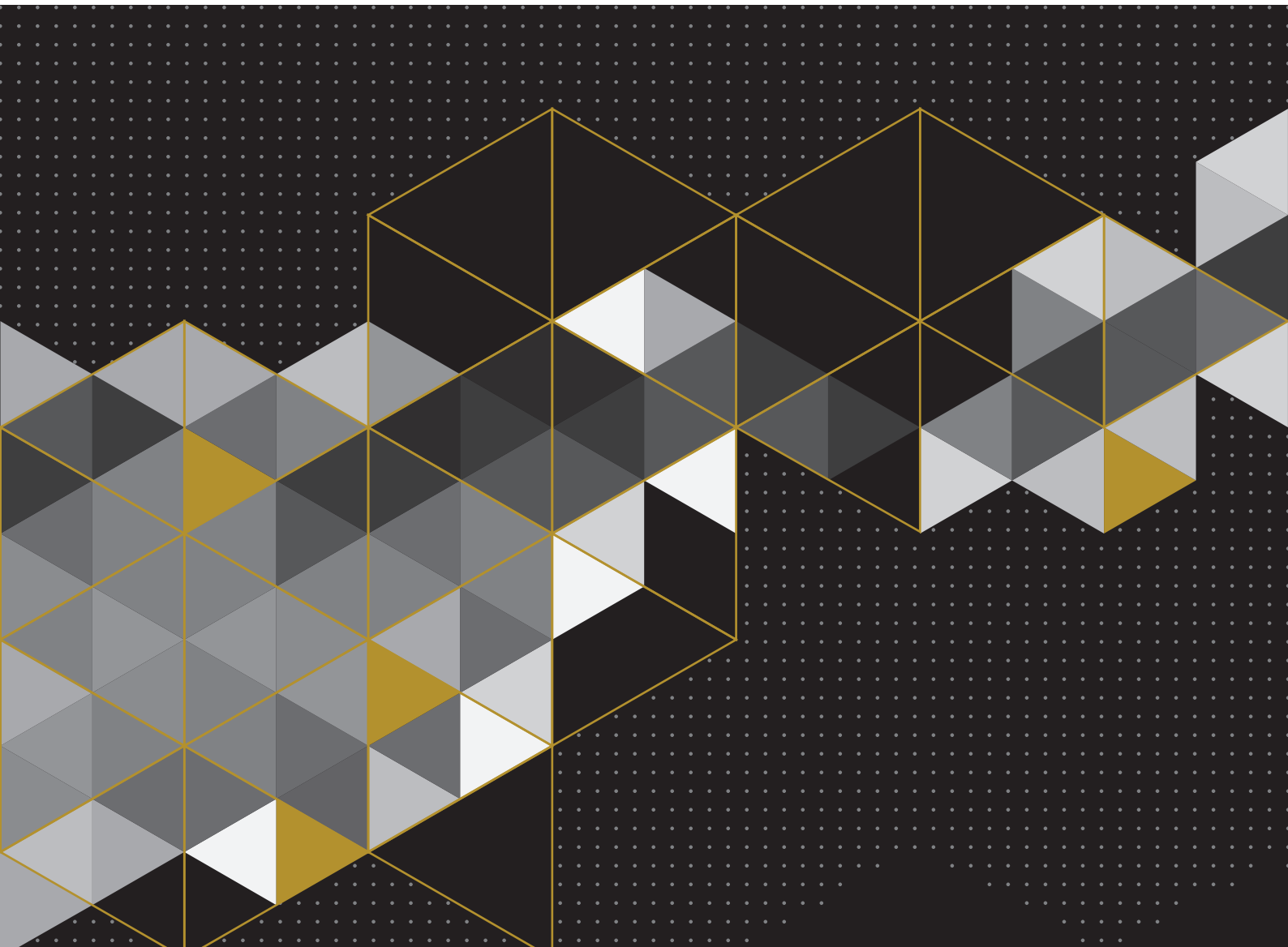

GENERAL
CATALOGUE
2017

PROIETTORI / SPOTLIGHTS



BINARI ELETTRIFICATI / ELECTRIFIED TRACKS



LIGHTING SYSTEMS

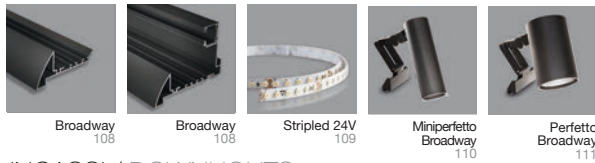

INCASSI / DOWNLIGHTS

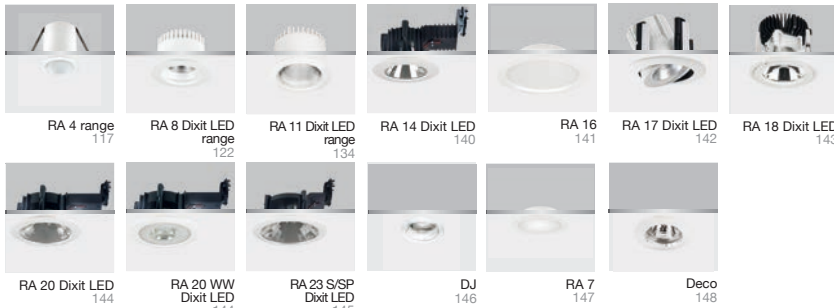

PROIETTORI DA INCASSO / RECESSED SPOTLIGHTS

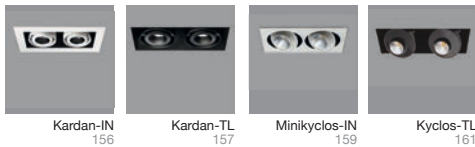

SOSPENSIONI / SUSPENSIONS



LUCI DA PLAFONE / CEILING LIGHTS



LUCI DA PARETE / WALL LIGHTS



LUCI LINEARI / LINEAR LIGHTS

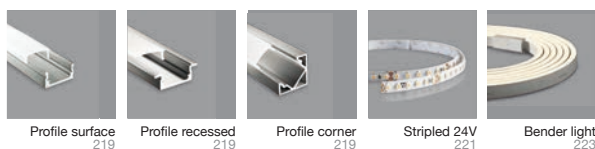

PROIETTORI DA ESTERNO / EXTERIOR SPOTLIGHTS

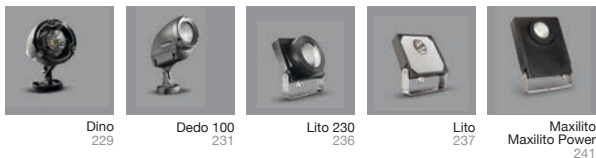

LUCI DA FACCIATA / FAÇADE LIGHTS



LUCI DA PLAFONE / CEILING LIGHTS



LUCI DA APPOGGIO / BOLLARDS



LUCI DA INCASSO PER ESTERNI / EXTERIOR RECESSED LIGHTS



PLAFONIERE / CEILING LIGHTS

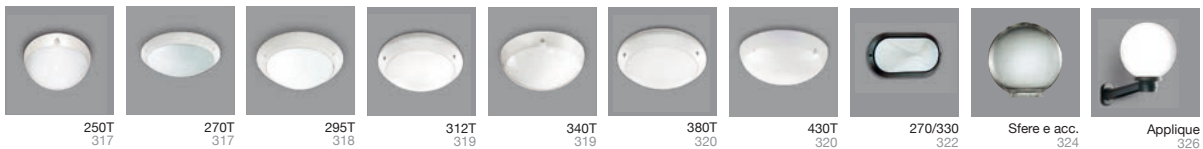





Miniperfetto

Studio Tecnico Ivela

News



News

Miniperfetto

Studio Tecnico Ivela







News

Perfetto Compact

Studio Tecnico Ivela

Interior Spotlights p. 51







News

Miniperfetto-S

Studio Tecnico Ivela

Suspension p. 169







Broadway

Studio Tecnico Ivela

News





News

RA 8 Soft Dixit LED RA 11 Soft Dixit LED

Studio Tecnico Ivela





Kardan TL

Studio Tecnico Ivela



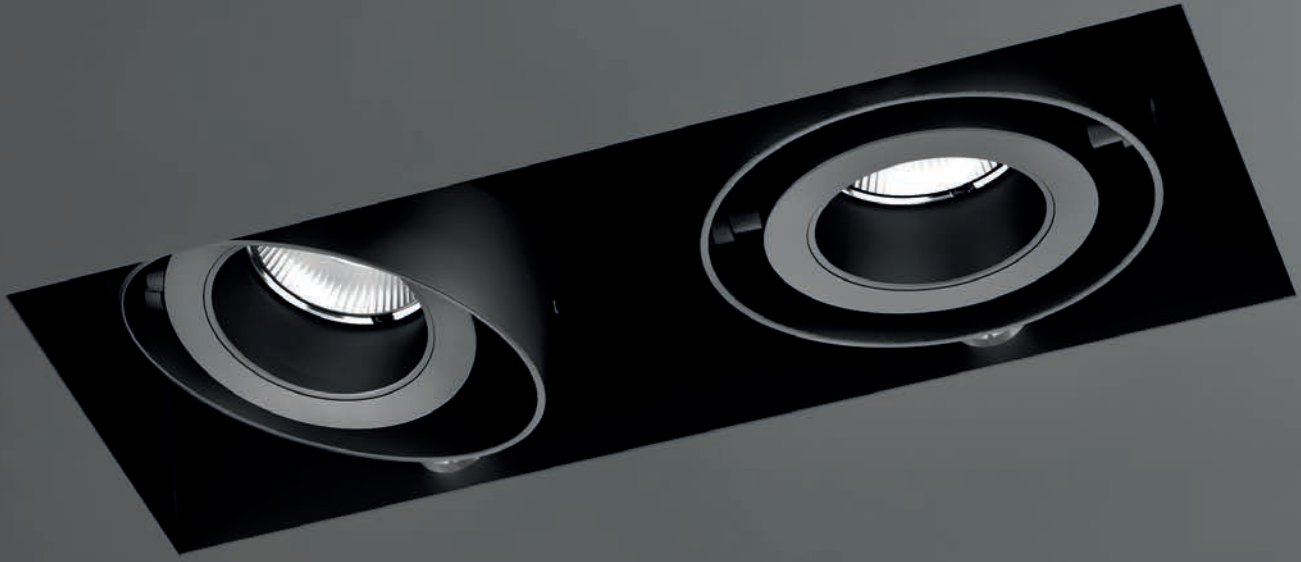



Lito 230

Enrico Davide Bona e Elisa Nobile

News



News



Balti 260

Enrico Davide Bona e Elisa Nobile

Façade Lights p. 254





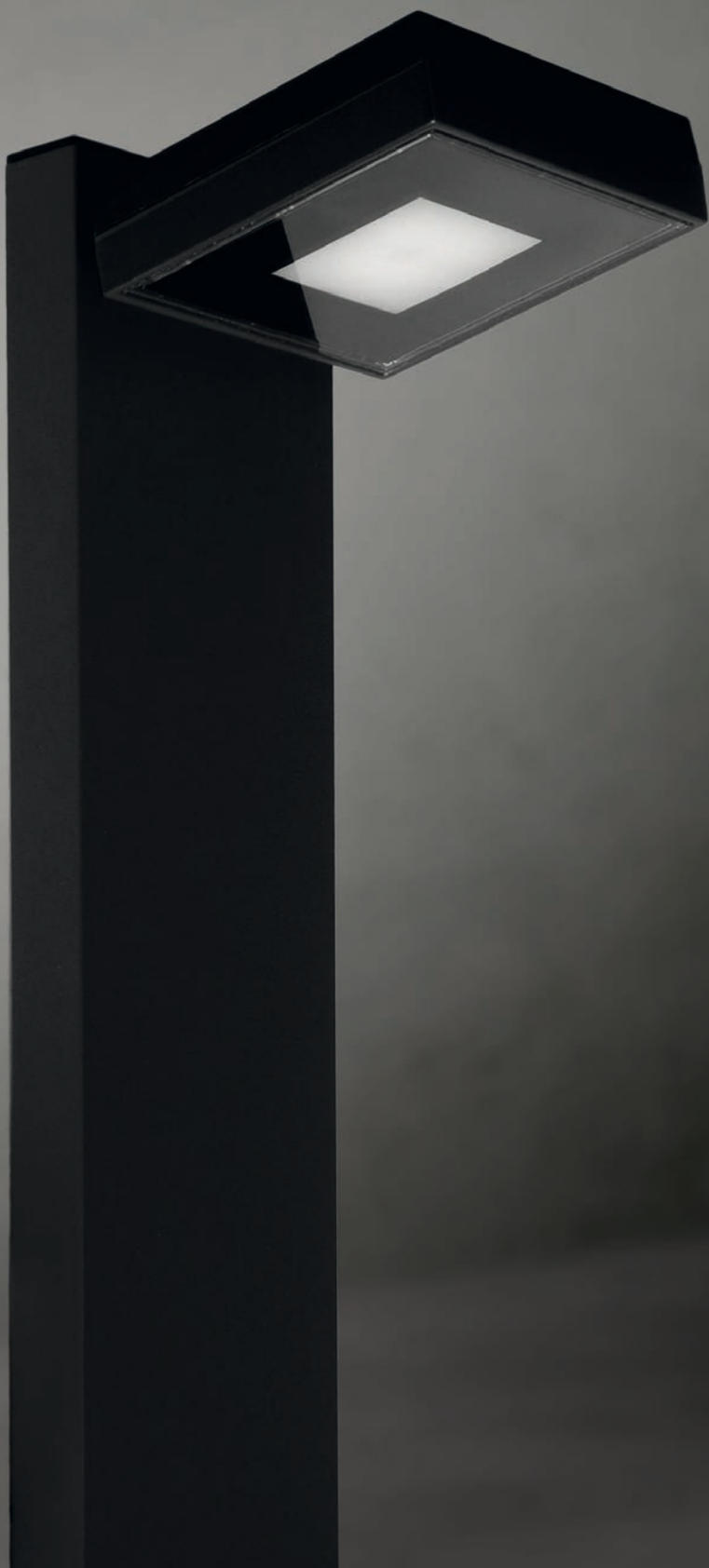

PN 110

Enrico Davide Bona e Elisa Nobile

Bollards p. 289









Bidi

Enrico Davide Bona e Elisa Nobile

News

About us

Da 30 anni Ivela investe in tecnologia, innovazione e qualità: oggi è leader nella fabbricazione di apparecchi di illuminazione architettonici e funzionali, esportati in tutto il mondo.

I prodotti, assolutamente Made in Italy, soddisfano molteplici esigenze sia per l'illuminazione di interni che di esterni. Ivela offre tutti i vantaggi di un'organizzazione industriale e commerciale in grado di supportare il cliente, dalla scelta dei prodotti, alla consulenza progettuale, ai servizi di assistenza post-vendita.

Negli ultimi anni Ivela ha incentrato la sua progettazione sull'emergente tecnologia a LED, impegnandosi nella ricerca e nello sviluppo delle migliori soluzioni illuminotecniche: apparecchi appositamente studiati per l'integrazione di sorgenti a LED ad alta potenza, in grado di far fronte alle sempre crescenti esigenze di eco-sostenibilità e risparmio energetico.

Ivela have been investing in technology, innovation and quality since 30 years: today they are leader in the manufacturing of architectural and functional lighting fixtures, which are exported worldwide.

Their products, totally Made in Italy, can fulfil multiple lighting needs, both indoor and outdoor. Ivela offer all the advantages of an industrial and commercial organization able to support the customer, from product selection, to project consulting and after-sale care.

During the last years Ivela have focused their engineering on the emerging LED technology, aiming at the research and the development of the best lighting solutions: fixtures specially designed for the integration of high power LED sources, able to face the growing requirements of eco-sustainability and energy saving.

Dietro la qualità dei suoi prodotti vive e lavora un'azienda attenta orgogliosamente italiana e tecnologicamente all'avanguardia, che si avvale di designer riconosciuti. L'ideazione e la progettazione nell'ufficio tecnico di ogni singolo prodotto, anche in esecuzioni personalizzate, fanno di Ivela un autentico partner produttore per soluzioni illuminotecniche.

Gli apparecchi Ivela coniugano perfettamente la qualità con soluzioni illuminotecniche che tengono conto di costi di esercizio contenuti, lunga durata e minima manutenzione.

L'Ufficio di Progettazione Illuminotecnica utilizza software all'avanguardia per elaborare progetti illuminotecnici. Collaborando con i clienti e sviluppando al meglio le potenzialità degli apparecchi prescelti, valorizza l'aspetto architettonico di ogni progetto attraverso l'uso consapevole della luce. Ogni progetto è personalizzato e seguito in ogni dettaglio utilizzando la rappresentazione prospettica e tridimensionale dell'ambiente, fino al calcolo illuminotecnico.

Behind the quality of their products, a proudly Italian company live and operate, working closely with celebrated designers.

The conception and the engineering in the technical office of every single product, including customized items, are the key factors for Ivela to be seen as a real partner-manufacturer in the lighting industry.

Ivela's products combine quality and lighting solutions that keep into consideration low operation costs, a long life and minimum maintenance.

Ivela's Lighting Design Team makes use of the most advanced programs to work out lighting projects. The architectural features are valorized through a well aware use of light, working together with customers and fully exploiting the potential of the lighting fittings chosen. Every project is customized and followed-up in all its steps, from creation of a 3D visuals of the rooms, up to the implementation of the final lighting calculation. requirements of eco-sustainability and energy saving.



Metaphisic Light

Ieri, oggi, domani: *la Luce*

In un presente dove l'apparecchio illuminante è sempre **più sinergico al progetto**, le architetture diventano protagoniste enfatizzate da fasci luminosi, giochi nascosti e da metafisiche installazioni.

Ivela nel 2017, **con le immagini di questa edizione**, vuole ricreare alcune delle atmosfere dove la struttura della sorgente luminosa rende protagonista la sua funzionalità. Grazie a nuove tecnologie la scomparsa dell'oggetto luminoso permette di creare ambienti sempre più ergonomici e porre attenzione maggiore ad una corretta illuminazione restituendo la sua efficienza nell'ambiente in cui si vive.

Un pensiero e una riflessione al nuovo processo illuminotecnico che ormai si è identificato e ha preso la strada in un nuova era: **quella del domani**.

Yesterday, today, tomorrow: *the Light*

In a time where lighting fittings are demanded to find growing **synergies with projects**, architectures play the leading role with increasing emphasis being placed on light beams, hidden light games and metaphisic installations.

Ivela in 2017 proposes the **pictures of this new catalogue** to recreate some atmospheres where the structure of the lighting source is intended to highlight its functionality. The new technologies allow the lighting fitting to disappear creating ergonomic environments focussed on a correct lighting design where higher efficiency is a paradigm.

Today's lighting is already **heading into the future**.

QUALITÀ E INNOVAZIONE

Qualità e innovazione evocano progresso e scoperta, affidabilità e design, rigore e creatività, che sono necessari per un'evoluzione costante e per creare valore nel tempo.

La nostra azienda opera in regime di controllo qualità, secondo le norme UNI EN ISO 9001:2008, a testimonianza di un'assoluta attenzione alla qualità dei processi aziendali.

Ivela esegue tutte le prove ed i test di prodotto all'interno del proprio laboratorio, riconosciuto ufficialmente dall'IMQ, Istituto Italiano Marchio di Qualità: e garantisce la sicurezza e l'osservanza di tutti gli apparecchi alle normative applicabili attraverso il marchio ENEC, prova certa della costante attuazione del Sistema Qualità Aziendale.

QUALITY AND INNOVATION

Quality and innovation evoke progress and discovery, reliability and design, precision and creativity, that are the key words for a constant evolution and for the creation of values through time. Our company operate under the UNI EN ISO 9001:2008 certification, granting a total quality control of company processes.

Ivela conduct all their product tests and trials in their own laboratory, officially accredited by the IMQ, Italian Quality Trademark Institute. They guarantee the safety and the compliance of all their equipments with the applicable Standards through the ENEC mark, which certifies the constant application of the Company Quality System.



A CHI CI RIVOLGIAMO?

Ci rivolgiamo a tutti coloro per cui la luce non è solo un apparecchio per illuminare, bensì uno strumento straordinario per dare vita e valore ai luoghi dell'abitare e del vivere.

Ci rivolgiamo a coloro per cui la funzionalità della luce non si ferma alla pura funzione tecnica, bensì tocca i più diversi aspetti di un approccio visivo e spaziale di un luogo, di un ambiente, di un'architettura.

La luce nel retail deve accentuare, evidenziare, emozionare, selezionare: gli apparecchi illuminotecnici per il retail devono essere precisi, flessibili, ottimizzati, performanti.

La luce nell'hospitality parla un altro linguaggio, deve ammorbidire, sfumare, diffondere, nascondere, incuriosire, dare benessere: gli apparecchi illuminotecnici per l'hospitality devono essere proporzionati, studiati, eleganti, ma altrettanto elaborati nel controllo dell'emissione luminosa, che deve essere misurata e confortevole.

Ci rivolgiamo a chi fa di queste distinzioni il proprio lavoro e la propria passione, aiutandolo nella progettazione e nella costruzione di un luogo studiato intorno alle esigenze dell'uomo.

WHO DO WE WANT TO SPEAK TO?

We want to speak to everybody considering light not only in terms of a fitting to make light, but rather an extraordinary tool to give life to, and valorize the places where people live and work.

We want to speak to everybody considering the function of light not merely limited to its technical aspects but rather focussing on the visual aspect of a place, an environment, an architecture in their relations with space

Light for retail must generate accents, bring out highlights, create feelings, support selection: the lighting fittings for retail must be precise, flexible, optimized, performing.

Light for hospitality speaks a different language, it must be smooth, soft, diffusing, hiding, generating curiosity and healthy feelings: lighting fittings for hospitality must be well-proportioned, cared, elegant but at the same time well controlled in terms of light emission that must be well-balanced and comfortable.

We want to speak to everybody with a passion for these issues, providing help to design and build the right places for people's ease and comfort.

PER COSA CI DISTINGUIAMO

Per cosa si distinguono i prodotti Ivela dagli altri prodotti di illuminazione?

Ogni prodotto è studiato a partire dai singoli componenti, secondo le loro specifiche caratteristiche e funzionalità, a partire dalla struttura dell'apparecchio, dalla scelta del LED e del driver, al disegno del dettaglio e degli snodi.

La qualità è il valore imprescindibile che Ivela si pone come obiettivo: dissipazione termica passiva, rapporto lumen/watt e Light Editing Ratio ottimali, resa cromatica standard elevata, sostituzione manuale di ottiche e accessori per il controllo dell'emissione luminosa sono alcune tra le caratteristiche dei prodotti Ivela.

WHAT MAKES US DIFFERENT

What makes Ivela fittings different from other lighting fittings?

Every product is created starting from its individual components, in accordance with their peculiar features and functionality, carefully determining the fitting's structure, its overall design, the led and the driver to use.

Quality is the key value Ivela is looking at: passive thermal dissipation, state-of-the art lumen/watt and light-editing ratios, high colour rendering, interchangeable reflectors and accessories for perfect light control are among the main features of all Ivela fittings.

PROGETTAZIONE ILLUMINOTECNICA LIGHTING DESIGN

La progettazione della luce è un fattore fondamentale nella definizione degli spazi architettonici e nella costruzione del comfort visivo.

Disegnare la luce vuol dire, in senso generale, offrire al cliente la possibilità di vivere gli spazi interni ed esterni in comodità e serenità ma, in realtà, vuol dire molto di più.

Significa assecondare lo sguardo di chi vive gli ambienti, regalare un'esperienza visiva e, non meno importante, garantire la sicurezza delle persone.

Il nostro ufficio di progettazione illuminotecnica è a completa disposizione del cliente per la realizzazione di calcoli illuminotecnici ad hoc.

Ciascun calcolo è seguito dalla fase iniziale fino all'installazione finale dei prodotti, in un percorso che nasce inevitabilmente dalla richiesta e dalla necessità del cliente e si sviluppa attraverso un dialogo continuo con il nostro gruppo di progettisti.

Lighting design is the key factor to define architecture spaces and to achieve visual comfort.

To design light means, in general, to offer customers the chance of living indoor and outdoor spaces comfortably and pleasantly but with much more that goes beyond that in reality.

It means to accompany the eye of those who live the environments, to provide a visual experience and, last but not least, to care for people's safety.

Our lighting design office is fully available to run ad hoc lighting calculations. Every calculation is followed-up from the first steps till final installation of the products, in a process that finds its foundations in customers' needs and enquiries, and develops through a continuous dialogue with our team of lighting designers.

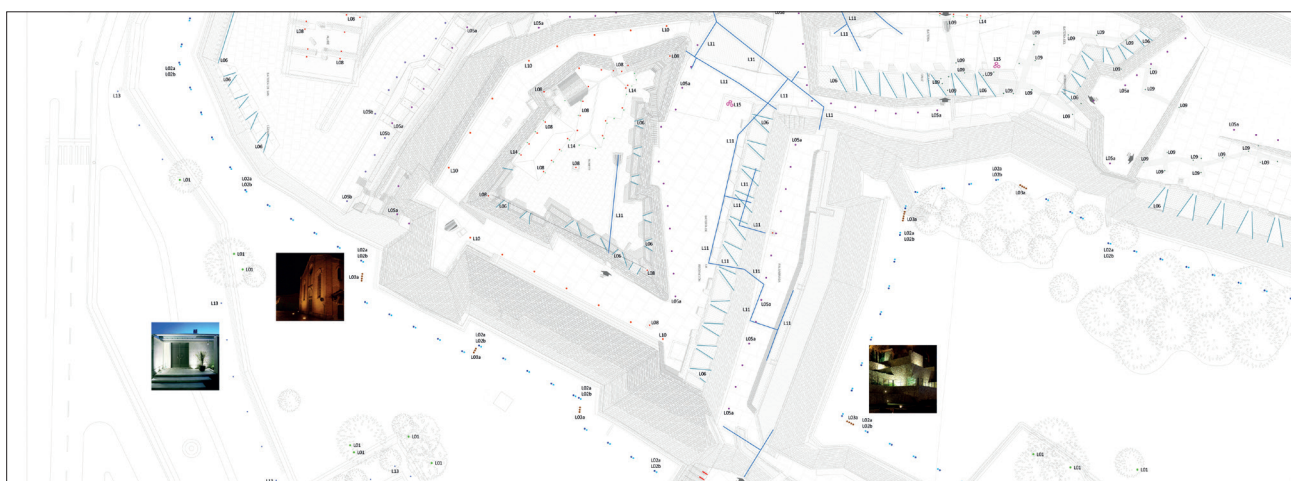
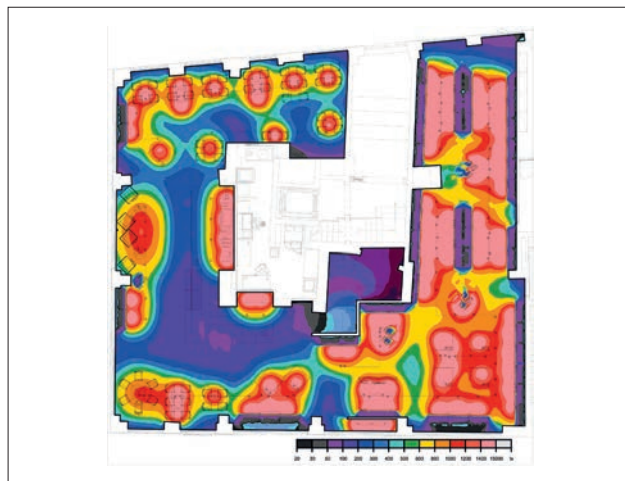

COME LEGGERE IL CATALOGO
HOW TO READ THE CATALOG

A PERFETTO

Proiettori / Spotlights

Codice Code	LED Lumen	Product Lumen	Watt	Colour T (K)	CRI	Fascio Beam
Per binari elettrici trifase LKM For LKM 3-phase electric tracks						
743-161	3100	2759	26	3000	85	25°
743-161A	3250	2883	26	4000	85	25°
743-268	4000	3560	33	3000	90	30°
743-461	5550	4940	43	3000	85	30°
743-461A	5650	5029	43	4000	85	30°
Con driver DALI (su richiesta) - Per binari dimmerabili DIM con apposito adattatore With DALI driver (on demand) - For dimmable tracks DIM with proper adapter						
747-469	4500	4005	43	3000	90	30°

21 Bianco mat
Mat white

21 Metal su richiesta
Silver on demand

220/240V - 50/60Hz

CE, RoHS, IP20, UGR<15, A+, H

F **743-161** **743-161A** **743-268** **747-469**

E

I

L

Accessori ottici intercambiabili
Replaceable optical accessories

	28-3140-51	Optica professionale S Professional optic device S
	28-3142-51	Optica professionale M Professional optic device M
	28-3138-51	Optica professionale W Professional optic device W
	28-3141-31	Optica professionale XW Professional optic device XW
	28-3957-30	Cilindro antistabbigliamento Snoot
	28-3959-30*	Frangiluce alveolare Honeycomb
	28-3956-58*	Vetro temperato trasparente Clear tempered glass
	28-3958-32*	Vetro temperato con filtro food rosato Pink tempered glass for food application

M

26W 33W 43W

* Accessori da utilizzare esclusivamente insieme a snoot cod. 28-3957-30
* Accessories to be used only with snoot code 28-3957-30

31

- A** Nome del prodotto
Product name
 - B** Specifiche tecniche
Technical specifications
 - C** Codice prodotto
Product code
 - D** Flusso luminoso
Luminous flux
 - E** Apertura del fascio
Beam angle
 - F** Disegno tecnico
Technical drawing
 - G** Colori prodotto
Product colours
 - H** Marchi e simbologie
Marks and symbols
 - I** Curva fotometrica
Photometric curve
 - L** Accessori
Accessories
 - M** Grafiche dei fasci
Beam graphics
- I flussi luminosi dei nostri apparecchi sono rilevati a regime termico di lavoro del prodotto
The luminous fluxes of our fittings are measured with the fittings warm from operation

CATALOGO ONLINE
WEB CATALOG



Il catalogo on-line è uno strumento completo, costantemente aggiornato in ogni sezione per conoscere tutti i prodotti e le novità Ivela.

All'interno del catalogo on-line è possibile: effettuare una ricerca parametrica avanzata strutturata in modo da filtrare le caratteristiche di prodotto (famiglie, applicazioni, tipologie di fasci, lampade...). Elaborare e scaricare la scheda tecnica approfondita per ogni codice di prodotto contenuto nel catalogo, completa di fotografie, disegni tecnici, marchi e simbologie e curve fotometriche.

Scaricare le istruzioni di montaggio e file fotometrici in formato IES e LDT Comparare due o più prodotti, sulla base di caratteristiche tecniche, per agevolare la scelta.

The on-line catalog is a complete tool, always updated in each section to inform about all products and news in Ivela.

The on-line catalog offers many possibilities: Making an advanced search structured with filters regarding product features (ranges, applications, light beams, lamps...) Generating and downloading an in-depth technical data sheet for each product reference within the catalog, complete with pictures, technical drawings, marks and symbols and photometric data.

Downloading mounting instructions and photometric data (IES, LDT) Comparing two or more fixtures, on the base of technical features, to help the user in the selection.



CURVA FOTOMETRICA

È una modalità grafica che visualizza la congiunzione dei punti che rappresentano i valori delle intensità luminose emesse in ogni direzione dello spazio dalla sorgente luminosa, formando così il "solido fotometrico".

Il solido, intersecato con dei piani, genera le curve fotometriche. Le curve fotometriche possono essere rappresentate secondo coordinate polari oppure cartesiane. I piani normalmente rappresentati sono: trasversale 0°- 180° (linea rossa), longitudinale 90° - 270° (linea blu).



Diagramma o curva fotometrica

L'insieme dei valori di intensità luminosa, rappresentato in coordinate polari su un piano, identifica una linea che viene detta "curva fotometrica" ed è generalmente riferito ad una sorgente che emette un flusso luminoso pari a 1000 lm.

Photometric curve or diagram

The values of luminous intensity, that are represented as polar coordinates on a plane, identify a line called "photometric curve". They are generally referred to a source emitting a luminous flux of 1000 lm.

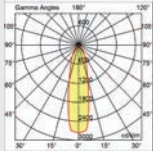
PHOTOMETRIC CURVE

It is a graph which visualizes the junction of the points indicating the luminous intensity distributed in every direction by a light source determining the "solid angle".

The solid angle, intersected with the planes, creates the photometric curves. Photometric curves can be illustrated utilizing polar or cartesian graphs.

The illustrated planes are normally: Transverse 0°-180° (red line), Longitudinal 90° - 270° (blue line).

CALCOLO UGR
UGR CALCULATION

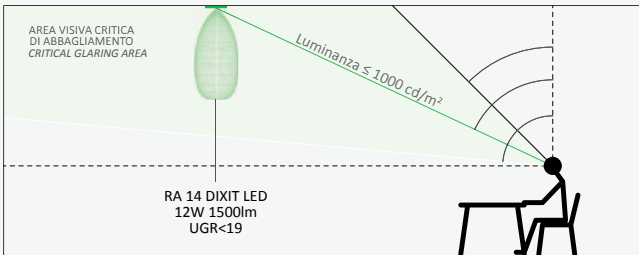

Reflectancies										
Ceiling/Cavity	0.7	0.7	0.5	0.5	0.3	0.7	0.7	0.5	0.5	0.3
Walls	0.5	0.3	0.5	0.3	0.3	0.5	0.3	0.5	0.3	0.3
WorkingPlane	0.2	0.2	0.2	0.2	0.2	0.2	0.2	0.2	0.2	0.2
RoomDimensions	ViewedCrosswise					ViewedEndwise				
x=4H y=2H	17.1	17.7	17.5	18.0	18.3	17.1	17.7	17.5	18.0	18.3
x=4H y=3H	17.2	17.7	17.6	18.0	18.3	17.2	17.7	17.6	18.0	18.3
x=4H y=4H	17.5	18.1	18.1	18.5	18.6	17.5	18.1	18.1	18.5	18.8
x=4H y=6H	18.3	18.7	18.7	19.1	19.5	18.1	18.7	18.7	19.1	19.5
x=4H y=8H	18.4	18.7	19.0	19.3	19.7	18.6	18.9	19.0	19.3	19.7
x=4H y=12H	18.6	18.8	19.3	19.5	19.7	18.6	19.1	19.3	19.5	19.9

VALORI UGR

L'UGR (Unified Glare Rating) è un indice unificato in campo internazionale per la valutazione dell'abbagliamento diretto di un impianto di illuminazione nel suo complesso, considerando cioè la disposizione degli apparecchi di illuminazione, le caratteristiche dell'ambiente (dimensioni, riflessioni) e il punto di osservazione degli utenti.

I valori indicano il grado di comfort visivo dato da un apparecchio rilevato all'interno di una stanza di dimensioni e indici di riflessione standard. Più basso è il valore di UGR, minore è l'abbagliamento diretto.

UGR VALUES













UGR (Unified Glare Rating) is a unified international index developed to evaluate direct glare in a light system, considering the position of luminaires, room characteristics (dimensions, reflections), and the observation point of workers.

These values indicate the visual comfort gradient of a luminaire, considering a room with standard dimensions and reflection indices.











The lower the UGR value, the less direct glare is.













MARCHI E SIMBOLOGIE MARKS AND SYMBOLS

-  **Apparecchio conforme ai requisiti di sicurezza Europei (direttive LVD 73/23 EEC – 93/68 EEC)**
Product in conformity with the requirements of relevant European Safety standards
-  **Apparecchio conforme ai requisiti di sicurezza USA e canadesi**
Fitting in conformity with the requirements of relevant USA and Canadian safety standards
-  **Apparecchio garantito e certificato dall' Istituto Italiano Marchio di Qualità**
Guaranteed product and certified by the Italian Quality Trademark Institute
-  **Marchio ENEC – European Norms Electrical Certification Prodotti costruiti e certificati secondo le Norme Europee**
European Norms Electrical Certification - Products manufactured and certified according to European Norms
-  **Classe I**
Apparecchio nel quale la protezione contro la scossa elettrica si basa sul contatto a terra
Class I
Fitting whose protection against electric shock is based on earth wiring
-  **Classe II**
Apparecchio nel quale la protezione contro la scossa elettrica si basa sul doppio isolamento rinforzato
Class II
Fitting whose protection against electric shock is based on reinforced double insulation
-  **Classe III**
Apparecchio nel quale la protezione contro la scossa elettrica si basa sull'alimentazione a bassissima tensione di sicurezza SELV, in cui non si producono tensioni superiori alla stessa
Class III
Fitting whose protection against electric shock is based on a safety extra low voltage supply SELV, in which voltages higher than those of SELV are not generated
-  **Apparecchio che può essere installato direttamente su superfici normalmente infiammabili**
Suitable for installation on normally flammable surfaces
-  **Apparecchio per servizio gravoso**
Light fixture for heavy-duty use
-  **Apparecchio che supera la prova del filo incandescente a 850°**
The fixture stands the glow-wire test at 850°
-  **Temperatura massima superficiale dell'apparecchio**
Highest surface temperature of the fitting
-  **Apparecchio certificato secondo la direttiva sul risparmio energetico 2010/30/UE**
Fixture certified following the directive 2010/30/UE, regarding energy saving.

CLASSIFICAZIONE DI PROTEZIONE INTERNAZIONALE INTERNATIONAL PROTECTION RATING

-  **Grado di protezione dell'apparecchio contro l'ingresso di solidi (identificato dalla prima cifra) e liquidi (identificato dalla seconda cifra)**
Protection rating classifying the degree of protection from solids (identified from the first character) and moisture (identified from the second character)
-  **IP20**
Protetto contro la penetrazione di corpi solidi di dimensioni superiori a Ø 12 mm.
Non protetto contro la penetrazione di liquidi
Protected against the ingress of solid bodies greater than Ø 12 mm.
No protection against the ingress of moisture
-  **IP33**
Protetto contro l'ingresso di oggetti solidi più grandi di Ø 2,5 mm.
Protetto contro acqua spruzzata
Protected against the ingress of solid bodies greater than Ø 2,5mm.
Protected against sprays of water
-  **IP40**
Protetto contro la penetrazione di corpi solidi di dimensioni superiori a Ø 1 mm.
Non protetto contro la penetrazione di liquidi
Protected against the ingress of solid bodies greater than Ø 1 mm.
No protection against the ingress of moisture
-  **IP43**
Protetto contro la penetrazione di corpi solidi di dimensioni superiori a Ø 1 mm.
Protetto contro la pioggia
Protected against the ingress of solid bodies greater than Ø 1 mm.
Protected against rain
-  **IP44**
Protetto contro la penetrazione di corpi solidi di dimensioni superiori a Ø 1 mm.
Protetto contro gli spruzzi
Protected against the ingress of solid bodies greater than Ø 1 mm.
Protected against splashing water
-  **IP65**
Protetto completamente contro la penetrazione di polvere
Protetto dai getti d'acqua
Protected against the ingress of dust
Protected against jets of water
-  **IP66**
Protetto completamente contro la penetrazione di polvere
Protetto dai getti d'acqua potenti
Protected against the ingress of dust
Protected from powerful jets of water
-  **IP67**
Protetto completamente contro la penetrazione di polvere
Protetto dall'immersione temporanea
Protected against the ingress of dust
Protected against immersion in water for limited periods
-  **IP68**
Protetto completamente contro la penetrazione di polvere
Apparecchi stagni all'immersione (con indicazione in metri di profondità consentita)
Protected against the ingress of dust
Protected against total immersion in water for an indefinite period (depth shown in metres)

-  **Grado di protezione degli involucri contro gli impatti meccanici esterni (EN 50102) misurabile in Joule**
Housing protection degree against mechanical shocks measurable in Joule

 IK01	0,15 J	 IK02	0,20 J	 IK03	0,35 J	 IK04	0,50 J	 IK05	0,70 J
 IK06	1,00 J	 IK07	2,00 J	 IK08	5,00 J	 IK09	10,0 J	 IK10	20,0 J







Miniperfetto LKM
p.44



Miniperfetto MM
p.44



Miniperfetto Base
p.45



Miniperfetto R
p.45



Perfetto Compact
p.51



Perfetto 230
p.52



Perfetto
p.53



Minikyclos 230
p.58



Minikyclos
p.59



Kyclos
p.64



Kyclos Power
p.65



Merlino 110 LED
p.69



Drim LED 230
p.71



Drim LED
p.72



Drim
p.73



Boma LED
p.77



Boma
p.77



Ayr
p.78



Flex
p.78



Spot B.T.
p.79



Spot B.T.
p.79



Proiettori

SPOTLIGHTS



Miniperfetto

Studio Tecnico Ivela

La serie **Miniperfetto** è sinonimo di versatilità: un design, molteplici applicazioni. Per offrire soluzioni illuminotecniche personalizzate e flessibili, ideali per ogni esigenza progettuale.

La gamma **Miniperfetto** comprende: proiettori compatti per binari trifase e monofase; con basetta per applicazioni a soffitto o a parete; con rosone incassato per un minore ingombro. Oltre a versioni a sospensione e per applicazioni nel sistema Broadway.

Le ottiche arretrate e lo snoot di serie rendono **Miniperfetto** ideale per le sue proprietà antiabbaglianti. Il suo design, dalle linee compatte e testa cilindrica estremamente elegante, si inserisce facilmente in numerosi contesti, dal retail, all'hospitality, al residenziale. **Miniperfetto**, con LED COB di ultima generazione, può essere personalizzato con una serie di accessori per un miglior comfort visivo.

The **Miniperfetto** series is synonymous with versatility: one design, multiple applications. In order to offer customized and flexible lighting solutions, ideal for any design requirements.

The **Miniperfetto** range includes: compact spotlights for three-phase and single-phase tracks; with base for wall or ceiling applications; with recessed canopy for a smaller volume. Furthermore, a suspended version and one for applications in the Broadway system.

The deeply-recessed optics and the standard snoot make **Miniperfetto** ideal for its anti-glare properties. Its design, featuring compact lines and extremely elegant cylindrical head, fits easily into a variety of contexts, from retail to hospitality, to the residential.

Miniperfetto, with COB LED of last generation, can be customized with a range of accessories for a better visual comfort.







Materiali:

- Corpo e base in pressofusione di alluminio verniciato poliestere
- Snodo in pressofusione di alluminio (per LKM) o in metallo cromato su finitura bianca oppure ottone su finitura nera (per MM)
- Ottiche professionali in termoplastico metallizzato a specchio
- Cilindro antiabbagliante interno in termoplastico nero

Materials:

- Body and base in die-cast aluminum polyester painted
- Joint in die-cast aluminum (for LKM) or chromed metal on white finish / brass on black finish (for MM)
- Professional optics in mirror metallized thermoplastic material
- Interior anti-glare cylinder in black thermoplastic material



ACCESSORI OTTICI - OPTICAL ACCESSORIES



S



Ottica metallizzata a fascio stretto, per luce d'accento, vetrine o soffitti elevati

Mirror metallized optic device for small beam angle, for accent light, shop windows or high ceiling



M



Ottica metallizzata a fascio medio, funzionale per ogni tipologia di retail

Mirror metallized optic device for medium beam angle, useful for every typology of retail



W



Ottica metallizzata a fascio aperto, per illuminazione diretta senza ombre nette

Mirror metallized optic device for wide beam angle, for direct lighting without sharp shadows



SNOOT



Cilindro che riduce l'angolo di abbagliamento diretto e consente il montaggio di altri accessori, perfetto per luce a spot e contrasti elevati

Cylinder that reduces direct glare angle and allows to use a thorough range of accessories, perfect for spot light and contrast effects



HONEYCOMB



Frangiluce alveolare per applicazioni che prevedono totale controllo dell'abbagliamento

Honeycomb for total glaring control



THERMOPLASTIC CLOSING SCREEN



Schermo per la protezione della fonte luminosa

Screen to protect the lighting source



MINIPERFETTO LKM



Codice Code	LED Lumen	Product Lumen	Watt	Colour T (K)	CRI	Fascio Beam
Per binari elettrificati trifase LKM For LKM 3-phase electrified tracks						
748-169	1450	1050	12	3000	90	30°
748-161A	1750	1258	12	4000	85	30°

220/240V - 50/60Hz

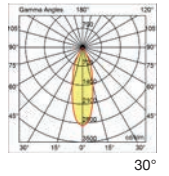
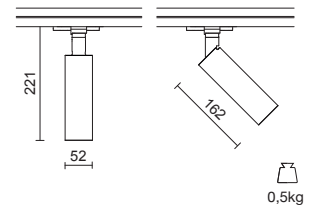

MINIPERFETTO MM



Codice Code	LED Lumen	Product Lumen	Watt	Colour T (K)	CRI	Fascio Beam
Per binari elettrificati monofase MM For MM single-phase electrified tracks						
748-159	1450	1050	12	3000	90	30°
748-151A	1750	1258	12	4000	85	30°

220/240V - 50/60Hz

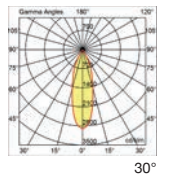
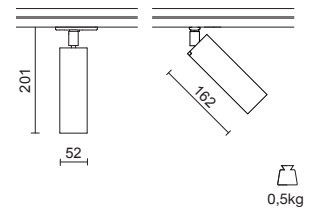
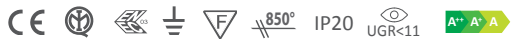

Accessori ottici intercambiabili Replaceable optical accessories



28-3901-51

Ottica professionale S
Professional optic device S

12W



28-3902-51

Ottica professionale M
Professional optic device M



28-3903-51

Ottica professionale W
Professional optic device W



28-3979-100

Cilindro antiabbagliamento dorato
Golden snoot



28-3905-47

Schermo di chiusura in termoplastico trasparente
Closing screen in clear thermoplastic material

* Accessorio da utilizzare esclusivamente insieme a cod. 28-3905-47



28-4022-30*

Frangiluce alveolare
Honeycomb

* Accessory to be used only with code 28-3905-47

MINIPERFETTO BASE



21 Bianco mat
Mat white

16 Nero
Black

Codice Code	LED Lumen	Product Lumen	Watt	Colour T (K)	CRI	Fascio Beam
Con base (driver integrato) With base (integrated driver)						
748-129	1090	800	9	3000	90	30°
748-029	800	600	6	3000	90	30°

6W: Regolabile sulla fase - Dimmable on the mains
220/240V - 50/60Hz

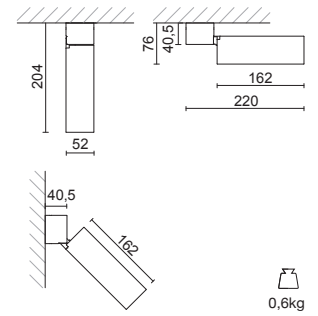

0,6kg

MINIPERFETTO R



21 Bianco mat
Mat white

16 Nero
Black

52 Metal su richiesta
Silver on demand

Con rosone per applicazione a incasso (driver da ordinare separatamente) With canopy for recessed applications (LED drivers should be ordered separately)						
750-271BN	2400	2136	18	3000	85	30°
750-271AN	2450	2181	18	4000	85	30°

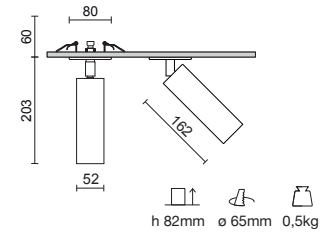
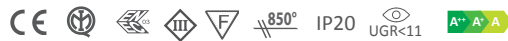

h 82mm ø 65mm 0,5kg

Driver da ordinare separatamente Drivers should be ordered separately	81-04011	18 W	Output 500mA
	81-04002	18 W	Output 500mA - Dimmerabile DALI - Dali dimmable

Accessori ottici intercambiabili Replaceable optical accessories



28-3901-51	Ottica professionale S Professional optic device S	9W 24°	18W 24°
28-3902-51	Ottica professionale M Professional optic device M	9W 30°	18W 30°
28-3903-51	Ottica professionale W Professional optic device W	9W 45°	18W 45°
28-3979-100	Cilindro antiabbagliamento dorato Golden snoot		
28-3905-47	Schermo di chiusura in termoplastico trasparente Closing screen in clear thermoplastic material		
28-4022-30*	Frangiluce alveolare Honeycomb		

9W 18W

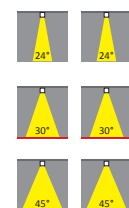

* Accessorio da utilizzare esclusivamente insieme a cod. 28-3905-47

* Accessory to be used only with code 28-3905-47





Perfetto

Studio Tecnico Ivela

Gamma di proiettori compatti per binari elettrificati trifase LKM, caratterizzata da linee semplici ed eleganti, progettata per ospitare i nuovi LED COB ad alta efficienza.

Perfetto è disponibile anche in versione con base per applicazioni a parete/soffitto, con LED a tensione di rete (230V) e con temperatura di colore 3000K o 4000K.

La disponibilità di differenti fasci luminosi, intercambiabili e sostituibili senza necessità di attrezzi, e l'orientamento del corpo fino a 350°, consentono molteplici soluzioni e regie luminose nel retail, in spazi commerciali, musei ed aree espositive.

Range of compact spotlights for LKM 3-phase electrified tracks, featuring simple and elegant lines, and equipped with the new high efficiency COB LEDs.

Perfetto is available also in a version with a base for wall/ceiling applications, with 230V supply voltage LED and with 3000K or 4000K colour temperature.

It is supplied with different light beams, interchangeable and easy to be replaced without tools, and it can be adjusted up to 350°, allowing many light solutions for shops, stores, museums and exhibition areas.

Modello di design depositato / Registered design model





Materiali:

- Corpo e vano componenti in pressofusione di alluminio verniciato poliesteri
- Ottiche professionali in termoplastico metallizzato a specchio
- Disponibili versioni con LED a tensione di rete (230V) oppure con driver, anche dimmerabile DALI.

Materials:

- Body and gear box in die-cast aluminium, polyester painted
- Professional optics in mirror metalized thermoplastic material
- Versions with supply voltage LED (230V) or with driver, also DALI dimmable, are available.





ACCESSORI OTTICI - OPTICAL ACCESSORIES



S



Ottica metallizzata a fascio stretto, per luce d'accento, vetrine o soffitti elevati

Mirror metallized optic device for small beam angle, for accent light, shop windows or high ceiling



M



Ottica metallizzata a fascio medio, funzionale per ogni tipologia di retail

Mirror metallized optic device for medium beam angle, useful for every typology of retail



W



Ottica metallizzata a fascio aperto, per illuminazione diretta senza ombre nette

Mirror metallized optic device for wide beam angle, for direct lighting without sharp shadows



XW



Ottica bianca a fascio diffuso, per ottenere luce generale

White metallized optic device for diffused beam angle, to get general light



SNOOT



Cilindro che riduce l'angolo di abbagliamento diretto e consente il montaggio di altri accessori, perfetto per luce a spot e contrasti elevati

Cylinder that reduces direct glare angle and allows to use a thorough range of accessories, perfect for spot light and contrast effects



HONEYCOMB



Frangiluce alveolare per applicazioni che prevedono totale controllo dell'abbagliamento

Honeycomb for total glaring control



CLEAR TEMPERED GLASS



Schermo per la protezione della fonte luminosa

Screen to protect the lighting source



PINK TEMPERED GLASS



Schermo con filtro food rosato per evidenziare le tonalità calde

Screen with pink food filter to enhance warm colours



PERFETTO COMPACT



21 Bianco mat
Mat white

16 Nero
Black

52 Metal su richiesta
Silver on demand

Codice Code	LED Lumen	Product Lumen	Watt	Colour T (K)	CRI	Fascio Beam
Per binari elettrificati trifase LKM For LKM 3-phase electrified tracks						
751-261	3100	-	26	3000	85	26°
751-261A	3200	-	26	4000	85	26°
Con base (su richiesta) With base (on demand)						
751-221	3100	-	26	3000	85	26°
751-221A	3200	-	26	4000	85	26°

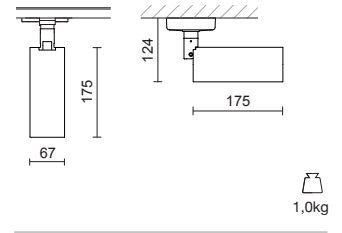

220/240V - 50/60Hz



Accessori ottici intercambiabili Replaceable optical accessories



28-3902-51

Ottica professionale M
Professional optic device M

26W



28-3903-51

Ottica professionale W
Professional optic device W



28-3903-31

Ottica professionale XW
Professional optic device XW



28-9004-30

Cilindro antiabbagliamento
Snoot



28-9005-30*

Frangiluce alveolare
Honeycomb



28-9006-32*

Vetro temperato con filtro food rosato
Pink tempered glass for food application



28-3905-47

Schermo di chiusura in termoplastico trasparente
Closing screen in clear thermoplastic material

* Accessori da utilizzare esclusivamente insieme a snoot cod. 28-9001-30

* Accessories to be used only with snoot code 28-9001-30



PERFETTO 230



21 Bianco mat
Mat white

16 Nero
Black

52 Metal su richiesta
Silver on demand

Codice Code	LED Lumen	Product Lumen	Watt	Colour T (K)	CRI	Fascio Beam
Per binari elettrificati trifase LKM For LKM 3-phase electrified tracks						
742-161	2000	1780	19	3000	80	38°
742-161A	2000	1780	19	4000	80	38°
742-261	3000	2670	33	3000	80	38°
742-261A	3000	2670	33	4000	80	38°
Con base (su richiesta) With base (on demand)						
742-121	2000	1780	19	3000	80	38°
742-121A	2000	1780	19	4000	80	38°

Con LED a tensione di rete regolabile sulla fase
With supply voltage LED dimmable on the mains

19W: 220/240V - 50/60Hz
33W: 230V - 50/60Hz

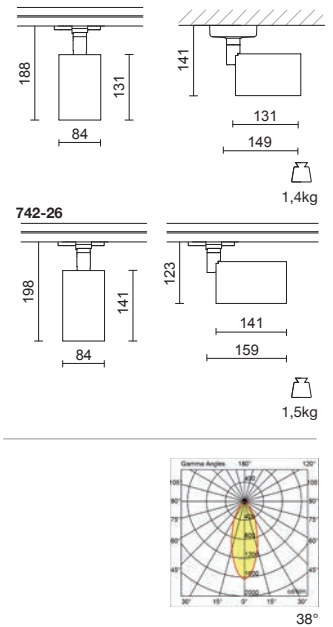

Accessori ottici intercambiabili Replaceable optical accessories



28-3140-51

Ottica professionale S
Professional optic device S

19W 33W

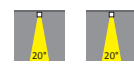

28-3142-51

Ottica professionale M
Professional optic device M

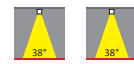

28-3138-51

Ottica professionale W
Professional optic device W

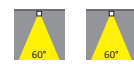

28-3141-31

Ottica professionale XW
Professional optic device XW

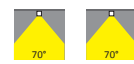

28-3957-30

Cilindro antiabbagliamento
Snoot



28-3959-30*

Frangiluce alveolare
Honeycomb



28-3958-58*

Vetro temperato trasparente
Clear tempered glass



28-3958-32*

Vetro temperato con filtro food rosato
Pink tempered glass for food application

* Accessori da utilizzare esclusivamente insieme a snoot cod. 28-3957-30

* Accessories to be used only with snoot code 28-3957-30



PERFETTO

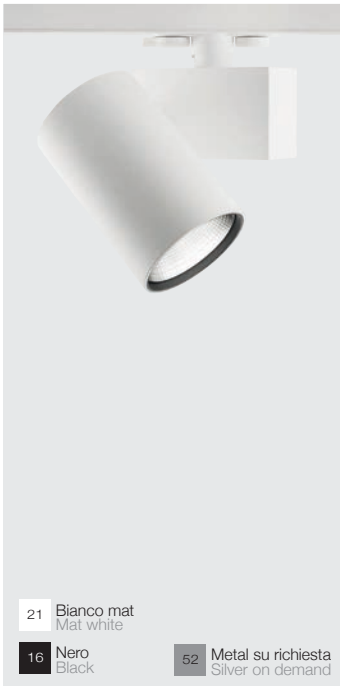

21 Bianco mat
Mat white

16 Nero
Black

52 Metal su richiesta
Silver on demand

Codice Code	LED Lumen	Product Lumen	Watt	Colour T (K)	CRI	Fascio Beam
Per binari elettrificati trifase LKM For LKM 3-phase electrified tracks						
743-161	3100	2759	26	3000	85	25°
743-161A	3250	2893	26	4000	85	25°
743-269	4000	3560	33	3000	90	30°
743-461	5550	4940	43	3000	85	30°
743-461A	5650	5029	43	4000	85	30°

Con driver DALI (su richiesta) - Per binari dimmerabili DKM con apposito adattatore
With DALI driver (on demand) - For dimmable tracks DKM with proper adapter

747-469	4500	4005	43	3000	90	30°
----------------	------	------	----	------	----	-----

220/240V - 50/60Hz

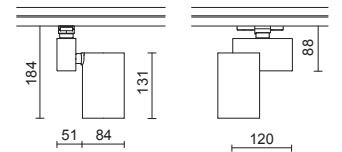
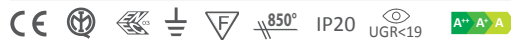

1,7kg

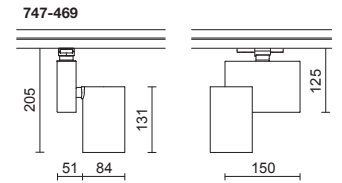

1,8kg

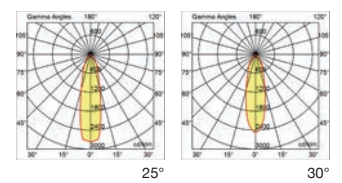

Accessori ottici intercambiabili
Replaceable optical accessories



28-3140-51

Ottica professionale S
Professional optic device S

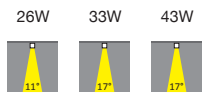

28-3142-51

Ottica professionale M
Professional optic device M

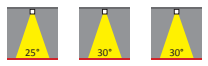

28-3138-51

Ottica professionale W
Professional optic device W



28-3141-31

Ottica professionale XW
Professional optic device XW

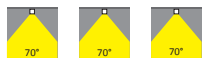

28-3957-30

Cilindro antiabbagliamento
Snoot



28-3959-30*

Frangiluce alveolare
Honeycomb



28-3958-58*

Vetro temperato trasparente
Clear tempered glass

* Accessori da utilizzare esclusivamente insieme a snoot cod. 28-3957-30



28-3958-32*

Vetro temperato con filtro food rosato
Pink tempered glass for food application

* Accessories to be used only with snoot code 28-3957-30





Minikyclos

design: **Enrico Davide Bona e Elisa Nobile**

Minikyclos è un proiettore per binari elettrificati trifase e monofase, progettato per ospitare LED COB di ultima generazione e caratterizzato da un innovativo sistema di dissipazione passiva del calore.

Minikyclos presenta un corpo dal design molto compatto che ben si accosta al vano ottico orientabile del prodotto, caratterizzato da dimensioni estremamente ridotte.

È disponibile con due diverse temperature di colore, 3000K e 4000K, anche in versione con LED a tensione di rete (230V).

Le dimensioni estremamente ridotte di **Minikyclos**, la versatilità dei fasci ottici, l'orientabilità del flusso luminoso di 350° rispetto all'asse orizzontale e verticale e l'elevato flusso luminoso, rendono questo proiettore idoneo come luce d'accento in svariati contesti quali negozi, showroom, gallerie d'arte e musei.

Minikyclos is a compact spotlight for single- and three-phase electrified tracks, designed to be equipped with COB LEDs of last generation, and characterized by an innovative passive heat dissipation system.

Minikyclos has a body with a compact design, well in balance with the tiltable spot head and with its extremely compact size.

It is available with different colour temperatures, 3000K and 4000K, also with supply voltage LED (230V).

Minikyclos is extremely compact in size, highly versatile in terms of beam angles, while its head can rotate and pivot by 350° with a high luminous flux. Thus it is ideal for accent lighting in a number of applications, such as shops, showrooms, art-galleries and museums.

Modello di design depositato / Registered design model



Materiali:

- Corpo e vano componenti in pressofusione di alluminio verniciato poliестere.
- Ottiche professionali in termoplastico metallizzato a specchio.
- Frontale di chiusura in policarbonato trasparente retroverniciato per un effetto di brillantezza e profondità

Disponibili versioni con LED a tensione di rete (230V) oppure con driver.

Materials:

- Body and gear box in die-cast aluminium, polyester painted.
- Reflector in thermoplastic material, mirror-metallized.
- Front closing screen in clear polycarbonate, backpainted for a brighter and deeper effect.

Versions with supply voltage LED (230V) or with driver are available.





MINIKYCLOS 230

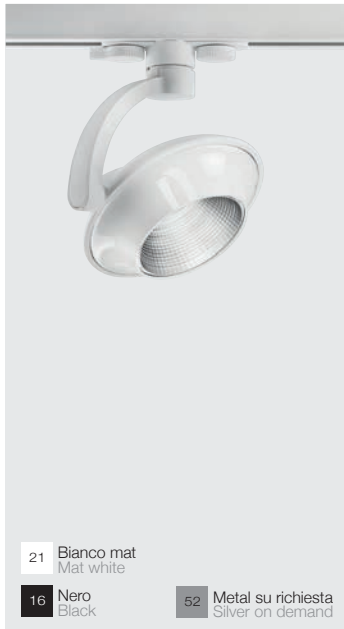

Codice Code	LED Lumen	Product Lumen	Watt	Colour T (K)	CRI	Fascio Beam
Per binari elettrificati trifase LKM For LKM 3-phase electrified tracks						
717-661	2000	1780	19	3000	80	38°
717-661A	2000	1780	19	4000	80	38°
Per binari elettrificati monofase MM For MM single-phase electrified tracks						
717-651	2000	1780	19	3000	80	38°
Con base With base						
717-621	2000	1780	19	3000	80	38°
717-621A	2000	1780	19	4000	80	38°

Con LED a tensione di rete regolabile sulla fase
With supply voltage LED dimmable on the mains

230V - 50/60Hz

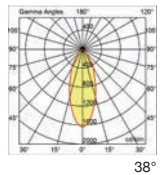
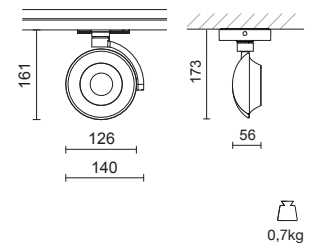
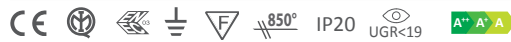

Accessori ottici intercambiabili Replaceable optical accessories



28-3140-51

Ottica professionale S
Professional optic device S

19W



28-3142-51

Ottica professionale M
Professional optic device M



28-3138-51

Ottica professionale W
Professional optic device W



28-3141-31

Ottica professionale XW
Professional optic device XW



28-3957-30

Cilindro antiabbagliamento
Snoot



28-3959-30*

Frangiluce alveolare
Honeycomb



28-3958-58*

Vetro temprato trasparente
Clear tempered glass



28-3958-32*

Vetro temprato con filtro food rosato
Pink tempered glass for food application

* Accessori da utilizzare esclusivamente insieme a snoot cod. 28-3957-30

* Accessories to be used only with snoot code 28-3957-30



MINIKYCLOS

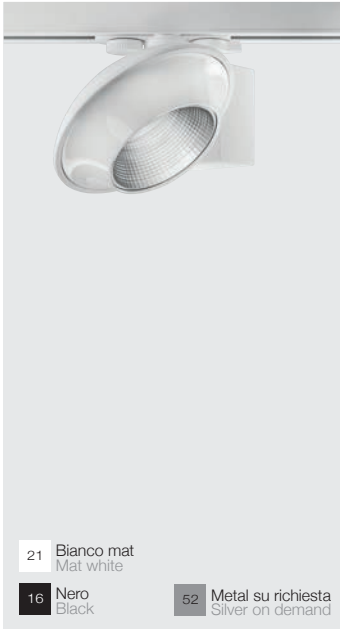

- 21 Bianco mat
Mat white
- 16 Nero
Black
- 52 Metal su richiesta
Silver on demand

Codice Code	LED Lumen	Product Lumen	Watt	Colour T (K)	CRI	Fascio Beam
Per binari elettrificati trifase LKM For LKM 3-phase electrified tracks						
717-161	2400	2136	18	3000	85	30°
717-161A	2450	2180	18	4000	85	30°
<hr/>						
717-261	3350	3037	26	3000	85	30°
717-261A	3300	2992	26	4000	85	30°
<hr/>						
717-369	3150	2917	27	3000	90	30°
717-361A	4000	3705	27	4000	85	30°
<hr/>						
Con base With base						
717-329	3150	2917	27	3000	90	30°
717-321A	4000	3705	27	4000	85	30°

220/240V - 50/60Hz

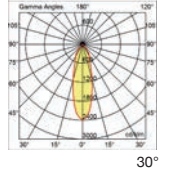
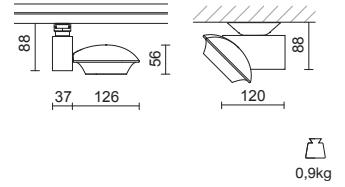

Accessori ottici intercambiabili Replaceable optical accessories



28-3140-51

Ottica professionale S
Professional optic device S

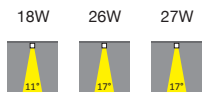

28-3142-51

Ottica professionale M
Professional optic device M

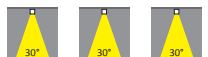

28-3138-51

Ottica professionale W
Professional optic device W



28-3141-31

Ottica professionale XW
Professional optic device XW

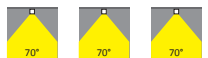

28-3957-30

Cilindro antiabbagliamento
Snoot



28-3959-30*

Frangiluce alveolare
Honeycomb



28-3958-58*

Vetro temprato trasparente
Clear tempered glass



28-3958-32*

Vetro temprato con filtro food rosato
Pink tempered glass for food application

* Accessori da utilizzare esclusivamente insieme a snoot cod. 28-3957-30

* Accessories to be used only with snoot code 28-3957-30





Kyclos & Kyclos Power

design: **Enrico Davide Bona e Elisa Nobile**

La gamma di proiettori per binari elettrificati **Kyclos** è ideata per LED COB ad alta efficienza e caratterizzata da un innovativo sistema di dissipazione passiva del calore. I flussi luminosi disponibili spaziano da 4900 a 9900 lumen. Il design pulito, che interpreta perfettamente la tecnologia LED emergente ed è contraddistinto da una continuità di linee morbide e sinuose, rende gli apparecchi adatti come luce d'accento in negozi, showroom, gallerie d'arte e musei. **Kyclos** e **Kyclos Power** possono essere equipaggiati con adattatore e alimentatore DALI per il controllo dei tempi di accensione e la gestione del flusso luminoso per ogni singolo punto luce. Da utilizzarsi su apposito binario DKM dimmerabile. Orientamento di 350° attorno agli assi verticale e orizzontale.

The **Kyclos** range of spotlights for electrified tracks has been developed expressly for LED COB latest technology and it is characterized by an innovative heat dissipation system.

Lumen outputs are available in a range from 4900 to 9900 lumen. The special, clean design is perfect for shop lighting applications, showrooms and museums as well. **Kyclos** and **Kyclos Power** can be equipped with a DALI adapter and driver to control the switching time and the luminous flux of every single spotlight. To be used on the specific DKM dimmable track. Orientation: 350° around the vertical and horizontal axis.

Modello di design depositato / Registered design model

**Materials:**

- Corpo e vano componenti in pressofusione di alluminio verniciati poliestere
- Ottiche professionali in termoplastico metallizzato a specchio
- Frontale di chiusura in policarbonato trasparente retroverniciato per ottenere un innovativo effetto brillante, senza viti a vista

Materials:

- Body and gear box in die-cast aluminium, polyester painted
- Professional optics in mirror-metallized thermoplastic material
- Front part in clear polycarbonate, rear painted for an innovative bright effect, without visible screws



Kyclos è disponibile in due versioni che si differenziano per dimensioni, flusso luminoso e forma del vano componenti. La versatilità di **Kyclos** a livello di aperture ottiche fornite come accessori e facilmente sostituibili senza necessità di attrezzi, permette di scegliere tra molti fasci intercambiabili per meglio differenziare le zone espositive. Sono disponibili una serie di accessori ottici per l'antiabbagliamento e il comfort visivo.

Kyclos is available in two versions with different dimensions, luminous fluxes and shape of the gear box. A range of different professional optics is also available as accessories, that can be easily replaced without tools. They allow to choose among different interchangeable beam angles, for a more flexible illumination of display areas. Some optical accessories for anti-dazzling and visual comfort are available.





KYCLOS

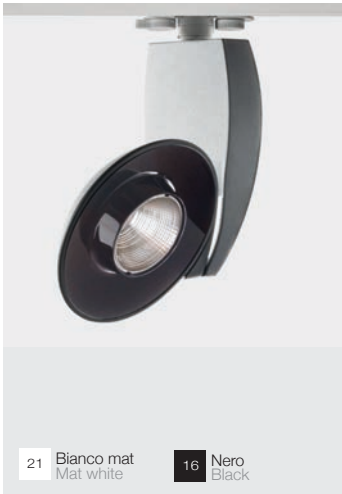

21 Bianco mat
Mat white

16 Nero
Black

Codice Code	LED Lumen	Product Lumen	Watt	Colour T (K)	CRI	Fascio Beam
-------------	-----------	---------------	------	--------------	-----	-------------

Per binari elettrificati trifase LKM
For LKM 3-phase electrified tracks

725-562	6400	5459	51	3000	85	30°
725-663	4900	4347	39	3000	85	30°

Con driver DALI (su richiesta) - Per binari dimmerabili DKM con apposito adattatore
With DALI driver (on demand) - For dimmable tracks DKM with proper adapter

725-861	6400	5459	51	3000	85	30°
----------------	------	------	----	------	----	-----

220/240V - 50/60Hz

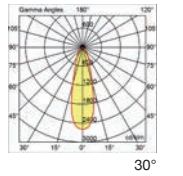
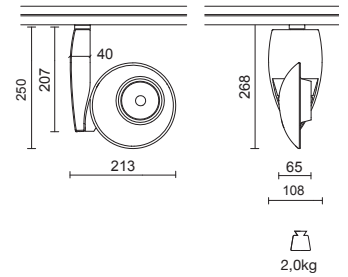

Accessori ottici intercambiabili Replaceable optical accessories



28-3140-51

Ottica professionale S
Professional optic device S

51W 39W



28-3142-51

Ottica professionale M
Professional optic device M

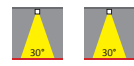

28-3138-51

Ottica professionale W
Professional optic device W



28-3141-31

Ottica professionale XW
Professional optic device XW

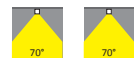

28-3957-30

Cilindro antiabbagliamento
Snoot



28-3959-30*

Frangiluce alveolare
Honeycomb



28-3958-58*

Vetro temprato trasparente
Clear tempered glass

* Accessori da utilizzare esclusivamente insieme a snoot cod. 28-3957-30



28-3958-32*

Vetro temprato con filtro food rosato
Pink tempered glass for food application

* Accessories to be used only with snoot code 28-3957-30



KYCLOS POWER



- 21 Bianco mat
Mat white
- 16 Nero
Black
- 52 Metal su richiesta
Silver on demand

Codice Code	LED Lumen	Product Lumen	Watt	Colour T (K)	CRI	Fascio Beam
Per binari elettrificati trifase LKM For LKM 3-phase electrified tracks						
719-261	9900	8906	75	3000	85	25°
Con base With base						
719-221	9900	8906	75	3000	85	25°

220/240V - 50/60Hz

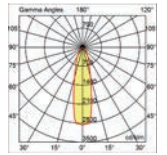
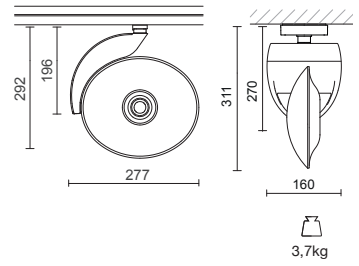

Accessori ottici intercambiabili

Replaceable optical accessories



28-3140-51

Ottica professionale S
Professional optic device S

75W



28-3142-51

Ottica professionale M
Professional optic device M



28-3138-51

Ottica professionale W
Professional optic device W



28-3141-31

Ottica professionale XW
Professional optic device XW



28-3957-30

Cilindro antiabbagliamento
Snoot



28-3959-30*

Frangiluce alveolare
Honeycomb



28-3958-58*

Vetro temprato trasparente
Clear tempered glass

* Accessori da utilizzare esclusivamente insieme a snoot cod. 28-3957-30



28-3958-32*

Vetro temprato con filtro food rosato
Pink tempered glass for food application

* Accessories to be used only with snoot code 28-3957-30





Merlino 110 LED

design: **Lorenzo Gecchelin**

Merlino 110 LED è un proiettore per binari elettrificati trifase LKM, con LED COB ad alta efficienza, dal design conico compatto ed essenziale, caratterizzato da alto rendimento luminoso e bassi consumi. **Merlino** è in grado di illuminare qualsiasi tipo di ambiente in negozi, centri commerciali, showroom e gallerie d'arte, combinando luce d'accento con elevate prestazioni.

Merlino 110 LED is a compact, conical and essential spotlight for LKM 3-phase electrified tracks with high luminous output and low energy consumption, with high efficiency COB LED **Merlino** can enlighten almost any type of environment in retail and also in shopping centres, showrooms and art galleries, combining accent lighting with great performance.

Modello di design depositato / Registered design model



Materiali:

- Corpo e anello frontale in pressofusione di alluminio verniciato poliester
- Ottiche professionali in termoplastico metallizzato a specchio

Materials:

- Body and front ring in die-cast aluminium, polyester painted
- Professional optics in mirror metallized thermoplastic material



MERLINO 110 LED



21 Bianco mat
Mat white

16 Nero
Black

52 Metal su richiesta
Silver on demand

Codice Code	LED Lumen	Product Lumen	Watt	Colour T (K)	CRI	Fascio Beam
Per binari elettrificati trifase LKM For LKM 3-phase electrified tracks						
791-311	4250	3774	33	3000	85	30°
791-411	5250	4510	36	3000	85	25°

220/240V - 50/60Hz

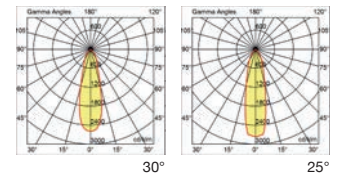
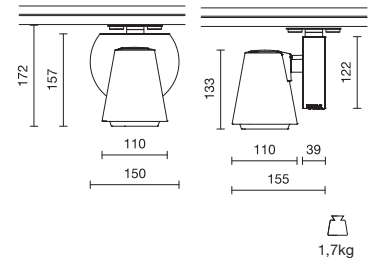

Accessori ottici intercambiabili

Replaceable optical accessories



28-3140-51

Ottica professionale S
Professional optic device S

33W 36W



28-3142-51

Ottica professionale M
Professional optic device M

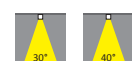

28-3138-51

Ottica professionale W
Professional optic device W



28-3141-31

Ottica professionale XW
Professional optic device XW



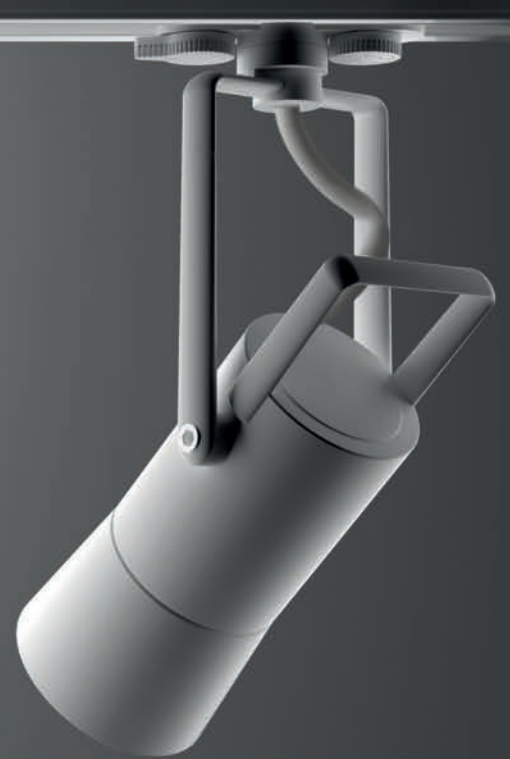

Drim

Studio Tecnico Ivela

Drim è una gamma di proiettori compatti ed efficaci per binari elettrificati trifase LKM e monofase MM. E' ideale per illuminare negozi, aree espositive, vetrine e showroom. Ospita differenti fonti luminose: LED COB ad alta efficienza di ultima generazione e lampade a ioduri metallici. Grazie al suo design sobrio ed essenziale, **Drim** è in grado di soddisfare, con il minimo ingombro, qualunque esigenza di illuminazione in modo accurato e preciso.

Drim può essere ruotato rispetto all'asse orizzontale fino ad un'ampiezza di 355°, di 45° verso l'alto e di 90° verso il basso rispetto all'asse verticale.

Drim LED con LED COB a tensione di rete è disponibile anche in versione con base per applicazione a soffitto e/o parete.

Disponibili, come accessori, ottiche professionali per **Drim LED** facilmente intercambiabili per variare il fascio luminoso, e accessori ottici per garantire anti-abbagliamento e comfort visivo.

Materiali:

- Corpo e staffe in pressofusione di alluminio verniciato poliestere
- Ottiche professionali in termoplastico metallizzato a specchio per Drim LED

Drim is a range of compact and effective spotlights for LKM 3-phase and single-phase MM electrified tracks. It is ideal to illuminate shops, exhibitions areas, show-cases and show-rooms. It is equipped with different lighting sources: high-efficiency COB LEDs of last generation and metal halide lamps.

Thanks to its sober and essential design and its reduced dimensions, **Drim** can provide an accurate and precise answer to a wide range of lighting needs.

Drim can be rotated up to 355° and pivot up to 45° upwards and 90° downwards thus pointing the light beam with the highest accuracy degree.

Drim LED with main voltage COB LED is available also with base for wall or ceiling applications.

Professional optics, that can be easily replaced, are available for different beam angles for **Drim LED**. Optic accessories that offer anti-dazzling and visual comfort are available, too.

Materials:

- Body and brackets in die-cast aluminium polyester painted
- Professional optic devices in mirror-metallized thermoplastic material for Drim LED

Modello di design depositato · Registered design model



DRIM LED 230



21 Bianco mat
Mat white

16 Nero
Black

52 Metal su richiesta
Silver on demand

Codice Code	LED Lumen	Product Lumen	Watt	Colour T (K)	CRI	Fascio Beam
Per binari elettrificati trifase LKM For LKM 3-phase electrified tracks						
738-910	2000	1776	19	3000	80	38°
738-810	3000	2670	33	3000	80	38°
Con base With base						
738-920	2000	1776	19	3000	80	38°
738-820	3000	2670	33	3000	80	38°

Con LED a tensione di rete regolabile sulla fase
With supply voltage LED dimmable on the mains

19W: 220/240V - 50/60Hz
33W: 230V - 50/60Hz

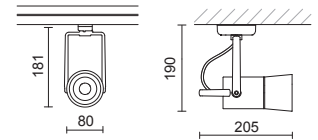

1,4kg

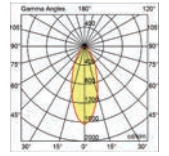

38°

Accessori ottici intercambiabili Replaceable optical accessories



28-3140-51

Ottica professionale S
Professional optic device S

19W 33W

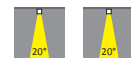

28-3142-51

Ottica professionale M
Professional optic device M



28-3138-51

Ottica professionale W
Professional optic device W



28-3141-31

Ottica professionale XW
Professional optic device XW

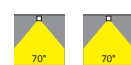

28-3957-30

Cilindro antiabbagliamento
Snoot



28-3959-30*

Frangiluce alveolare
Honeycomb



28-3958-58*

Vetro temprato trasparente
Clear tempered glass

* Accessori da utilizzare esclusivamente insieme a snoot cod. 28-3957-30



28-3958-32*

Vetro temprato con filtro food rosato
Pink tempered glass for food application

* Accessories to be used only with snoot code 28-3957-30



DRIM LED



21 Bianco mat
Mat white

16 Nero
Black

52 Metal su richiesta
Silver on demand

Codice Code	LED Lumen	Product Lumen	Watt	Colour T (K)	CRI	Fascio Beam
Per binari elettrificati trifase LKM For LKM 3-phase electrified tracks						
738-610	4250	3774	33	3000	85	30°
738-710	4900	4209	38	3000	85	30°

220/240V - 50/60Hz

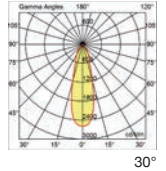
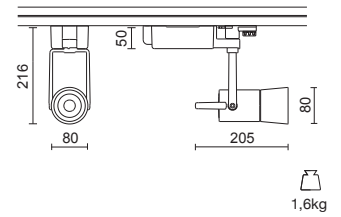

Accessori ottici intercambiabili Replaceable optical accessories



28-3140-51

Ottica professionale S
Professional optic device S

33W 38W



28-3142-51

Ottica professionale M
Professional optic device M

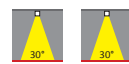

28-3138-51

Ottica professionale W
Professional optic device W



28-3141-31

Ottica professionale XW
Professional optic device XW

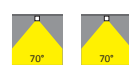

28-3957-30

Cilindro antiabbagliamento
Snoot



28-3959-30*

Frangiluce alveolare
Honeycomb



28-3958-58*

Vetro temprato trasparente
Clear tempered glass

* Accessori da utilizzare esclusivamente insieme a snoot cod. 28-3957-30



28-3958-32*

Vetro temprato con filtro food rosato
Pink tempered glass for food application

* Accessories to be used only with snoot code 28-3957-30



DRIM

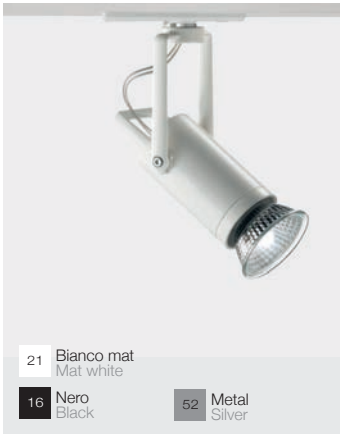

21 Bianco mat
Mat white

16 Nero
Black

52 Metal
Silver

Codice Code	Lampada Lamp	Watt	Attacco Base
Per binari monofase MM For MM single-phase electrified tracks			
740-035	IPAR16 / 20	50 / 75	GZ10

230V - 50/60Hz

CE IP20



DRIM

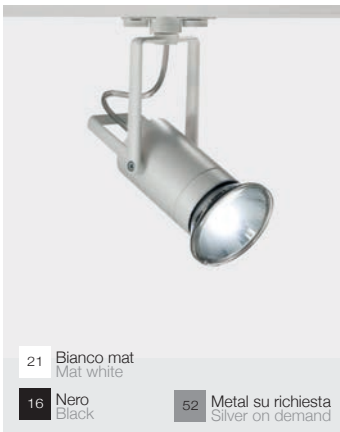

21 Bianco mat
Mat white

16 Nero
Black

52 Metal su richiesta
Silver on demand

Per binari elettrificati trifase LKM For LKM 3-phase electrified tracks			
738-016	IPAR30	Max 100	E27
Per binari monofase MM For MM single-phase electrified tracks			
738-035	IPAR30	Max 100	E27
Con base With base			
738-020	IPAR30	Max 100	E27

250V - 50/60Hz

CE IP20





Boma LED & Boma

design: **Enrico Davide Bona e Elisa Nobile**

Dotati di elevata potenza luminosa, **Boma** e **Boma LED** sono apparecchi di illuminazione lineare per binari elettrificati trifase LKM. Progettati per lampade fluorescenti lineari T5 o LED ad alto rendimento, sono disponibili versioni con base per applicazioni a parete e/o soffitto oppure a sospensione.

Boma è dotato di un reattore elettronico multi potenza che, grazie al riconoscimento della lampada, consente l'applicazione di sorgenti luminose di differente potenza, con conseguente risparmio energetico.

Gli apparecchi sono applicati ai binari mediante un meccanismo a snodo brevettato che consente loro di assumere posizioni variabili, secondo un'innovativa doppia rotazione.

Boma e **Boma LED** sono modelli di Utilità per l'orientamento e la rotazione brevettati.

Boma and **Boma LED** are linear lighting fittings for LKM 3-phase electrified tracks. They are designed for high luminosity linear T5 fluorescent lamps or LEDs, and they are available in versions with base for ceiling and/or wall mounting, or suspended.

Boma has a high frequency multipower gear, which automatically recognizes the lamp. This allows for the use of luminous sources of different wattages according to the applications, resulting in energy and cost savings, and in a greater flexibility of use.

The fittings can be applied to tracks through a patented joint mechanism that allows them to be adjusted in variable positions, according to an innovative double rotation.

Boma and **Boma LED** are patented as Utility models for orientation and rotation.

Modelli di design depositati / Registered design models
Modelli di Utilità brevettati / Patented as Utility models



Materiali:

- Corpo in estruso di alluminio verniciato poliester
- Diffusore in policarbonato opale, stabilizzato ai raggi UV e antiurto, per Boma LED
- Diffusore estruso millerighe in policarbonato per Boma
- Riflettore porta cablaggio in estruso di alluminio verniciato poliester bianco
- Chiusure laterali in nylon caricato F.V.30% verniciato a liquido
- Viteria in acciaio

Materials:

- Housing in extruded aluminium, polyester-painted
- Opal polycarbonate diffuser, UV stabilized and shockproof for Boma LED
- Extruded ribbed polycarbonate diffuser for Boma
- Gear-tray in white extruded aluminium, polyester painted
- Closing caps in nylon, reinforced with fiberglass 30%, liquid painted
- Steel screws



BOMA LED



08 Bianco mat
Mat white

09 Nero su richiesta
Black on demand

52 Metal su richiesta
Silver on demand

Codice Code	LED Lumen	Watt	Colour T (K)	CRI	Fascio Beam	Lunghezza (mm) Length (mm)
Per binari elettrificati trifase LKM For LKM 3-phase electrified tracks						
453-160	4000	30	3000	80	110°	915
453-260	5000	35	3000	80	110°	1200

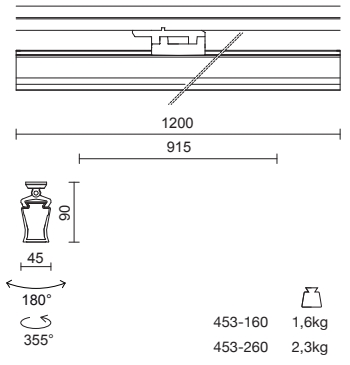

Versione a plafone, vedi pag. 197 - Versione a sospensione, vedi pag. 181
Ceiling version, see page 197 - Suspension version, see page 181

230/240V - 50/60Hz



BOMA



08 Bianco mat
Mat white

52 Metal su richiesta
Silver on demand

Codice Code	Lampada Lamp	Watt	Attacco Base	Fascio Beam	Lunghezza (mm) Length (mm)
Per binari elettrificati trifase LKM For LKM 3-phase electrified tracks					
450-361	FD / T5	1x35/49/80	G5	110°	1490

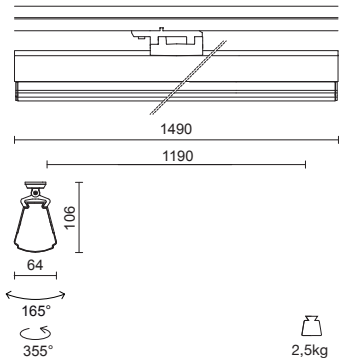

230/240V - 50/60Hz

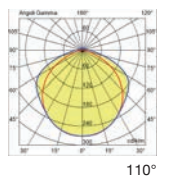



Ayr & Flex

Studio Tecnico Ivela

Mini proiettore per applicazione su binari elettrificati trifase LKM, adatto per illuminare vetrine di negozi, esposizioni d'arte e showroom.

Mini spotlight for application on LKM 3-phase electrified tracks, suitable for the illumination of shopwindows, art exhibitions and show rooms.

AYR



- 31 Bianco White
- 30 Nero Black
- 20 Metal Silver

Codice Code	Lampada Lamp	Watt	Attacco Base
Corpo in pressofusione di alluminio verniciato poliesteri, per binari elettrificati trifase LKM Housing in die-cast aluminium, polyester painted, for 3-phase electrified tracks LKM			
713-016	IPAR16	50	GU10
712-016	IPAR20/30/38	Max 100	E27

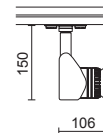

0,5kg

50W: 230V - 50/60Hz

CE □ F 850° IP20

FLEX



- 21 Bianco mat Mat white
- 16 Nero Black

Corpo in acciaio stampato verniciato poliesteri, per binari elettrificati trifase LKM Housing in pressed steel, polyester painted, for 3-phase electrified tracks LKM			
720-016	IPAR30	75	E27

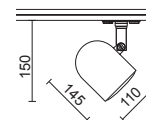

0,4kg

CE □ F 850° IP20



Spot B.T.

Studio Tecnico Ivela

Gli Spot a bassa tensione possono essere applicati al binario a bassa tensione Light Kit ELV. Disponibili differenti lunghezze di tige.

Per applicare gli Spot al binario a bassa tensione Light Kit ELV, si deve ordinare separatamente l'adattatore con l'attacco a Jack codice 6601-00, per intercambiabilità dei corpi illuminanti e direzionalità a 360°.

The low voltage spotlights can be applied directly to the Light Kit ELV low voltage track, using the Jack adapter designed for the purpose. Different pipe lengths are available.

To apply low-voltage spotlights with pipe to the low voltage Light Kit ELV track, the Jack adapter must be ordered separately (code 6601-00), for interchangeability of the spotlights and 360° orientation.

SPOT B.T.

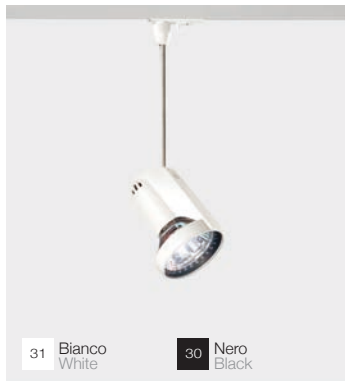

31 Bianco White 30 Nero Black

Codice Code	Lampada Lamp	Attacco Base	Tige (cm)
Corpo in pressofusione di alluminio verniciato poliester, per binari elettrificati a bassa tensione ELV Die-cast aluminium body, polyester painted for low voltage electrified tracks ELV			
6123-07	HR 50W/LED MR16 4W	GU5.3	7
6123-10	HR 50W/LED MR16 4W	GU5.3	10
6123-20	HR 50W/LED MR16 4W	GU5.3	25



0,08kg



SPOT B.T.

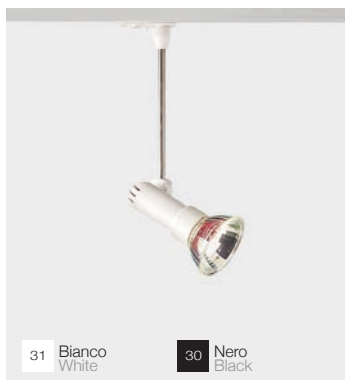

31 Bianco White 30 Nero Black

Codice Code	Lampada Lamp	Attacco Base	Tige (cm)
Corpo in pressofusione di alluminio verniciato poliester, per binari elettrificati a bassa tensione ELV Die-cast aluminium body, polyester painted for low voltage electrified tracks ELV			
6124-10	HR 50W/LED MR16 4W	GU5.3	10

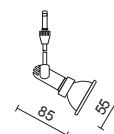

0,05kg



Adattatori
Adapters



6601-00

Adattatore con attacco a Jack 12V-5A
Jack adapter 12V - 5A

31 30



DKM Dimmable
p.86



LKM 3-phase
Tondo/Round
p.90



LKM 3-phase
Quadro/Square
p.92

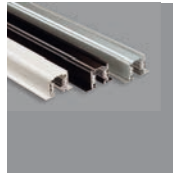

LKM 3-phase
Incasso/Recessed
p.94



MM Single-phase
p.97



E.L.V
B.T.
p.99



Binari elettrificati

ELECTRIFIED TRACKS



Binari elettrificati

La gamma di **binari** Ivela comprende **binari dimmerabili, trifase, monofase e a bassa tensione**, in grado di adattarsi in modo flessibile alle più svariate esigenze di illuminazione.

I **binari** sono progettati per essere facilmente installati a soffitto, a parete oppure incassati, per l'utilizzo di proiettori o apparecchi a sospensione. La semplicità di installazione degli apparecchi consente di avere impianti di illuminazione facilmente modificabili senza la necessità di interventi tecnici onerosi, così da creare scenari dinamici adattabili ai diversi ambienti.

CARATTERISTICHE TECNICHE

I **binari elettrificati** sono costruiti in lega di alluminio estruso. I cavi conduttori in rame sono alloggiati all'interno di profilati estrusi in PVC ad alta resistenza di isolamento.

Certificati dall'Istituto Italiano Marchio di Qualità (IMQ), sono conformi alle norme vigenti (EN 60570).

I sistemi comprendono un'ampia varietà di accessori e di giunti di collegamento.

The Ivela **track** range includes **dimmerable, three-phase, single-phase and low voltage tracks**, able to fit with different lighting demands in a flexible way.

Tracks are designed to be easily installed on the ceiling, on the wall or recessed, for use with spotlights or with suspended fittings.

An easy and quick installation allows to change the lighting layout at any time, avoiding expensive works, to provide dynamic solutions for the needs of different spaces.

TECHNICAL SPECIFICATIONS

Electrified tracks are made of extruded aluminium alloy. The copper wires are located inside extruded PVC profiles with high insulating properties.

They are certified by the Italian Quality Marking Institution (IMQ) and comply with current standards (EN 60570).

A wide range of joints and accessories is available.



DKM DIMMERABILE / DKM DIMMABLE

I binari dimmerabili DKM monofase permettono di gestire una varietà di applicazioni per la programmazione luminosa (DALI, DMX, 1-10V). Questa tecnologia consente, oltre a un consistente risparmio energetico, la possibilità di dar vita a scenografie luminose personalizzate adatte alle diverse esigenze progettuali, quali ambienti espositivi, spazi polifunzionali e centri commerciali.

The DKM dimmable tracks are applicable with the main systems in use to control light (DALI, DMX, 1-10V).

This technology generates significant economies in terms of energy saving and it is ideal for a customized approach to the use of light in different situations, such as exhibition areas, shopping and multifunctional centres.

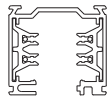

Tondo
Round

Quadro
Square

Incasso
Recessed

LKM TRIFASE / LKM THREE-PHASE

Light Kit Main è un sistema di binari trifase per tre circuiti elettrici separati. Le tre varianti di sezione, tonda, quadra o da incasso, permettono un utilizzo in molteplici ambienti.

Light Kit Main is a three-phase track system with 3 separate circuits. Three different designs (round, square or recessed) make the system highly versatile for a wide range of applications.

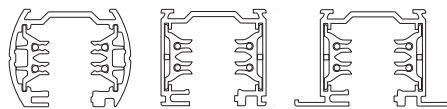

MM MONOFASE / MM SINGLE-PHASE

Mini Main è un sistema di binari monofase a una accensione, di facile installazione.

Mini Main is a single-phase, single switch electrified track system, easy to install.

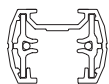



DKM

Dimmerabile/Dimmable

Il **binario** monofase dimmerabile **DKM**, a sezione quadra, è disponibile in quattro differenti lunghezze per applicazioni a plafone e a sospensione.

Il **binario DKM** è idoneo per l'applicazione dei principali sistemi di programmazione luminosa (DALI, DMX, 1-10V).

Alimentazione alla rete monofase 230-250V, carico complessivo di 16A corrispondente a 3680/4000W.

Sono disponibili proiettori con driver DALI e appositi adattatori per binari dimmerabili DKM.

The single-phase dimmable **track DKM**, square-shaped, is available in four different lengths for installation on the ceiling or suspended.

The **DKM track** is applicable with the main systems in use to control light (DALI, DMX, 1-10V).

Connection to single phase 230-250V mains, total load of 16A corresponding to 3680/4000W.

Spotlights including DALI drivers and specific adapters are available for DKM dimmable tracks.



LUCE DINAMICA

La possibilità di gestire, da un sistema remoto, l'intensità dei flussi luminosi di ogni singolo punto luce in modo indipendente consente un elevato livello di personalizzazione e di valorizzazione delle aree espositive. I sistemi di controllo dell'illuminazione consentono un reale miglioramento dell'efficienza energetica e permettono di creare opportunità scenografiche della luce in diverse applicazioni, quali ambienti espositivi, musei, centri commerciali.

DYNAMIC LIGHT

Remote light control for the variation of the light intensity of each fitting in an independent way allows both a high level of customization and the right emphasis in exhibition areas. Light control systems make it possible to achieve real improvements in terms of energetic efficiency and to create scenic effects with light for different applications such as exhibition areas, museums, shopping centres.

SCHEMA ELETTRICO

Il collegamento alla rete elettrica monofase 230/250V consente un carico complessivo di 16A che corrisponde a 3680/4000 Watt.

WIRING DIAGRAM

Connection to single phase 230/250V mains allows a total load of 16A corresponding to 3680/4000W.

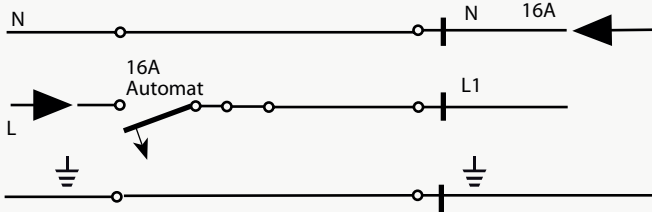

CAPACITÀ DI CARICO

Il binario può sopportare un carico di 2 Kg ogni 800 mm.

The track has a load capacity of 2 Kg every 800 mm.
In case of 10 Kg load every

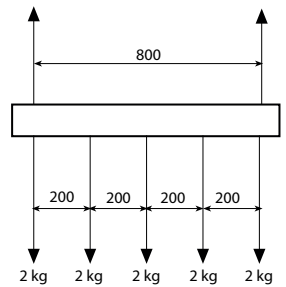

LOAD CAPACITY

Nel caso di carico di 10 Kg ogni 200 mm, la distanza di fissaggio deve essere di 400 mm.

200 mm, a distance of 400 mm between the fixing points is recommended.

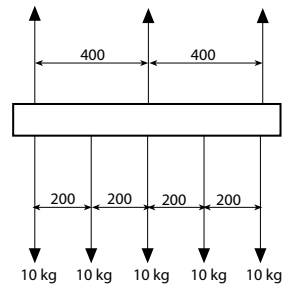

ACCESSORI

Il binario DKM è corredato da una serie di accessori dedicati (adattatore e connettori di alimentazione), e di altri in comune con il sistema quadro LKM.

ACCESSORIES

The DKM track system includes a range of specific accessories such as an adapter and live-ends, together with a set of other accessories, that are in common with the LKM square system.



DKM

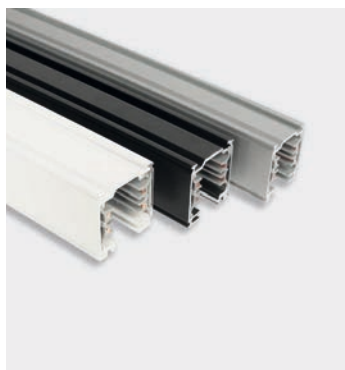

- 31 Bianco / White
- 30 Nero / Black
- 42 Anodizzato naturale / Satin silver

Codice / Code	Lunghezza (mm) / Length (mm)
Binario monofase DKM dimmerabile / DKM single-phase dimmable track	
7520-10	1000
7520-20	2000
7520-30	3000
7520-40	4000

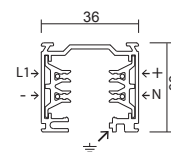

230V/250V-16A

CE, RoHS, Energy Star, F, 850° IP20

Adattatore e alimentatori / Adapter and live-ends











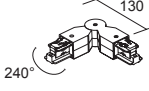





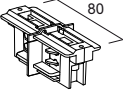



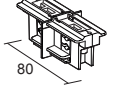



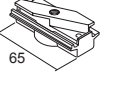





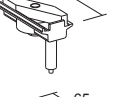





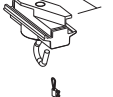





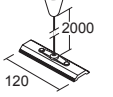



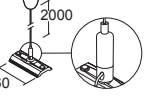



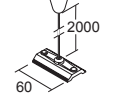



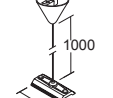







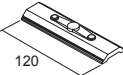

		7559-00	Adattatore elettromeccanico 6A, carico meccanico 10kg / Electro/mechanical adapter 6A, mechanical load 10kg		
		7651-10-W	Alimentazione destra / Right live-end		
		7651-11-W	Alimentazione sinistra / Left live-end		
		7661-10-W	Alimentazione centrale e giunto lineare / Central connector and straight joint		

Accessori DKM / DKM accessories

		7655-10-W	Giunto L interno / Inside L joint		
		7655-11-W	Giunto L esterno / Outside L joint		
		7656-10-W	Giunto T destro / Right T joint		
		7656-11-W	Giunto T sinistro / Left T joint		
		7657-10-W	Giunto X / X joint		
		7658-10-W	Giunto flessibile / Flexible joint		

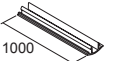

Accessori DKM
DKM accessories

		7660-00-W	Giunto mobile Mobile joint				
		7604Q-10-W	Giunto lineare con contatti e con blocco Electrical straight joint with stop				
		7654-10-W	Giunto lineare con blocco senza contatti (solo meccanico) Mechanical straight joint with stop				
		7625-00	Adattatore meccanico Mechanical adapter				
		7618-00	Adattatore meccanico con bloccacavo Mechanical adapter with automatic locking				
		7617-00	Adattatore meccanico con gancio Mechanical adapter with hook				
		7606-05	Kit sospensione con cavo acciaio mm 2000 e piastrina mm 120 Suspension kit with steel wire mm 2000 and mm 120 plate				
		7606-06	Kit sospensione con cavo acciaio mm 2000, piastrina mm 60 e bloccacavo automatico Suspension kit with steel wire mm 2000, mm 60 plate and automatic locking device				
		7606-00	Kit sospensione con cavo acciaio mm 2000 e piastrina mm 60 Suspension kit with steel wire mm 2000 and mm 60 plate				
		7626-00-00	Kit sospensione con tige mm 1000 e rosone traslucido Suspension kit with pipe mm 1000 and translucent ceiling base				
		7659-00-W	Terminale di chiusura Dead end				
		7606-04-00	Piastrina mm 120 Plate mm 120				
		7609-00-00	Raccordo per adattatore elettromeccanico M10x1 Nut for electro/mechanical adapter M10x1				
		7607-00-00	Kit attacco soffitto Ceiling kit				
		7624-00	Copertura binario mm 1000 Track cover mm 1000				



LKM

Trifase/Three-phase

Light Kit Main è un sistema di binari trifase, a tre accensioni, disponibile in quattro lunghezze per applicazioni a plafone e a sospensione.

Le differenti versioni, da appoggio o da incasso, soddisfano ogni esigenza di installazione. La completezza degli accessori rende **LKM** ideale nella progettazione illuminotecnica per flessibilità e versatilità.

Tensione di rete 230/250V. Tensione di rete industriale 380/440V. Carico complessivo 16A.

TIPOLOGIE DI BINARI

Il **binario trifase LKM** è disponibile in tre versioni: a sezione tonda e quadra, per applicazioni a plafone o a parete, e da incasso. Il **binario trifase LKM** da incasso è dotato di due alette laterali che permettono l'appoggio su controsoffitti o pannellature.

Light Kit Main is a system of three-phase tracks with three circuits, available in 4 different lengths for installation on the ceiling or on the wall.

The range, which also includes recessed tracks, is suitable for several installation needs. The complete range of accessories makes **LKM** extremely flexible and versatile in lighting design. Power supply 230/250V. Industrial power supply 380/440V. Total load 16A.

TRACK VERSIONS

The **three-phase LKM track** is available in 3 designs: round or square shaped for installation on the ceiling or on the wall, and recessed. The recessed **three-phase LKM track** is supplied with two side wings, to allow installation in false ceilings and panels.



CONTINUITÀ DELLA MESSA A TERRA

Per una corretta installazione di tutti gli accessori che concorrono alla formazione di un impianto di binari trifase, ha grande importanza la continuità della linea di messa a terra tra ogni elemento. Il posizionamento dei conduttori di terra, infatti, deve essere consequenziale tra componente e componente.



CONTINUITY OF THE EARTHING

For a correct installation of all the accessories in a three-phase track composition, the continuity of the earthing between each element has the highest importance. The earth conductors of each component must be positioned consistently.

Conduttore di terra con alimentazione sinistra L

Conduttore di terra con alimentazione destra R

Live-end with earth on the left L

Live-end with earth on the right R

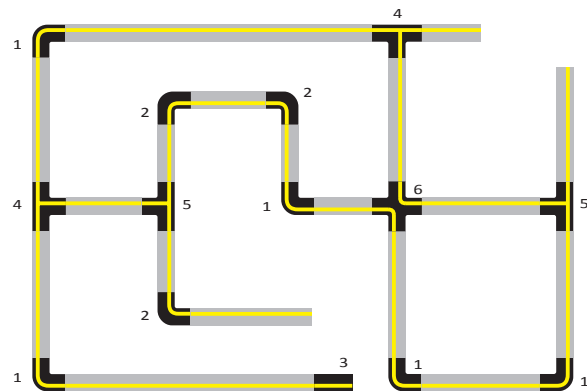

1 Giunto L esterno
Outside L joint



2 Giunto L interno
Inside L joint



3 Alimentazione destra
Right live-end



4 Giunto T destro
Right T joint



5 Giunto T sinistro
Left T joint



6 Giunto a X
X joint

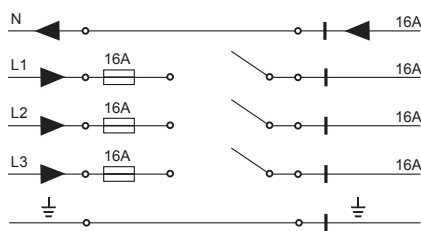
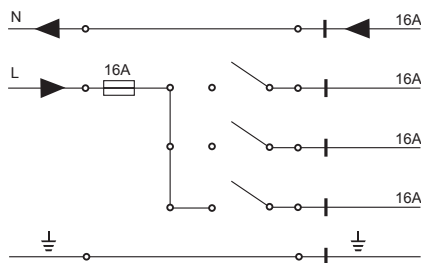

SCHEMI ELETTRICI

Il collegamento a una rete elettrica monofase 230/250V consente un carico complessivo di 16A, che corrisponde a 3680/4000 Watt suddivisibile su tre circuiti.

WIRING DIAGRAMS

The connections to a single phase 230/250V mains allows a total load of 16A, corresponding to 3680/4000 Watt, which can be divided among 3 circuits.

Il collegamento alla rete elettrica trifase 230/400V consente un carico complessivo di 16A, che corrisponde a 11040 Watt ripartibili su tre circuiti (3x3680 Watt).

The connection to a three-phase 230/400V electricity mains allows a total load of 16A, corresponding to 11040 Watt, which can be divided among 3 circuits (3x3680 Watt).

CAPACITÀ DI CARICO

I binari trifase LKM possono sopportare un carico di 2 Kg ogni 200 mm con una distanza massima fra i punti di fissaggio di 800 mm.

Nel caso di carico di 10 Kg ogni 200 mm, la distanza di fissaggio deve essere di 400 mm.

LOAD CAPACITY

LKM three-phase tracks have a load capacity of 2 Kg every 200 mm, with a maximum distance of 800 mm between the fixing points.

For a 10 Kg load every 200 mm, a maximum fixing distance of 400 mm is recommended.

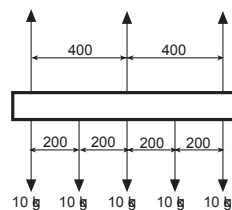
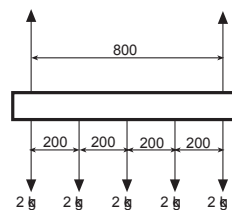

LKM

TONDO/ROUND



- 31 Bianco
White
- 30 Nero
Black
- 42 Anodizzato naturale
Satin silver

Codice Code	Lunghezza (mm) Length (mm)
Binario LKM trifase tondo LKM 3-phase track round	
7501-10	1000
7501-20	2000
7501-30	3000
7501-40	4000

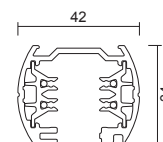

230V/440V-16A

CE IP20

Adattatori e alimentatori Adapters and live-ends











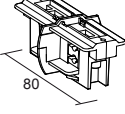



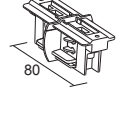



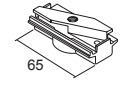





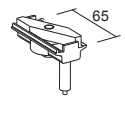





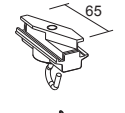





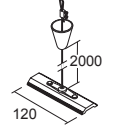



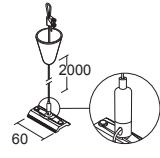



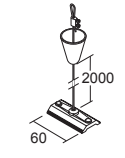



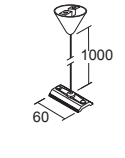







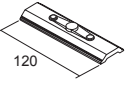

		7600-00	Adattatore elettromeccanico 6A, portata 10kg Electro/mechanical adapter 6A, load 10kg	20 30 31	
		7601-00-W	Adattatore elettromeccanico 6A, portata 5kg Electro/mechanical adapter 6A, load 5kg	20 30 31	
		7602-10-W	Alimentazione destra Right live-end	20 30 31	
		7602-11-W	Alimentazione sinistra Left live-end	20 30 31	
		7603-10-W	Alimentazione centrale e giunto lineare Central connector and straight joint	20 30 31	

Accessori LKM tondo Round LKM accessories

		7605-10-W	Giunto L interno Inside L joint	20 30 31	
		7605-11-W	Giunto L esterno Outside L joint	20 30 31	
		7621-10-W	Giunto T destro Right T joint	20 30 31	
		7621-11-W	Giunto T sinistro Left T joint	20 30 31	
		7622-10-W	Giunto X X joint	20 30 31	
		7610-10-W	Giunto flessibile Flexible joint	20 30 31	

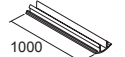

Accessori LKM tondo
Round LKM accessories

		7619-10-W	Giunto lineare con blocco senza contatti (solo meccanico) Mechanical straight joint with stop				
		7604T-10-W	Giunto lineare con contatti e con blocco Electrical straight joint with stop				
		7625-00	Adattatore meccanico Mechanical adapter				
		7618-00	Adattatore meccanico con bloccacavo Mechanical adapter with automatic locking				
		7617-00	Adattatore meccanico con gancio Mechanical adapter with hook				
		7606-05	Kit sospensione con cavo acciaio mm 2000 e piastrina mm 120 Suspension kit with steel wire mm 2000 and mm 120 plate				
		7606-06	Kit sospensione con cavo acciaio mm 2000, piastrina mm 60 e bloccacavo automatico Suspension kit with steel wire mm 2000, mm 60 plate and automatic locking device				
		7606-00	Kit sospensione con cavo acciaio mm 2000 e piastrina mm 60 Suspension kit with steel wire mm 2000 and mm 60 plate				
		7626-00-00	Kit sospensione con tige mm 1000 e rosone traslucido Suspension kit with pipe mm 1000 and translucent ceiling base				
		7623-00-W	Terminale di chiusura Dead end				
		7606-04-00	Piastrina mm 120 Plate mm 120				
		7609-00-00	Raccordo per adattatore elettromeccanico M10x1 Nut for electro/mechanical adapter M10x1				
		7607-00-00	Kit attacco soffitto Ceiling kit				
		7624-00	Copertura binario mm 1000 Track cover mm 1000				

LKM
QUADRO/SQUARE



- 31 Bianco
White
- 30 Nero
Black
- 42 Anodizzato naturale
Satin silver

Codice Code	Lunghezza (mm) Length (mm)
Binario LKM trifase quadro LKM 3-phase track square	
7511-10	1000
7511-20	2000
7511-30	3000
7511-40	4000

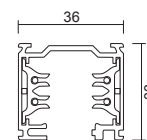

230V/440V-16A

CE $\neq 850^\circ$ IP20

Adattatori e alimentatori
 Adapters and live-ends











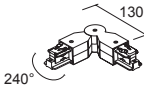





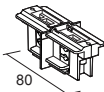



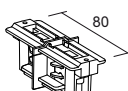



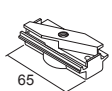





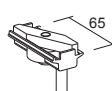





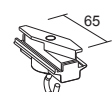





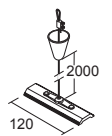



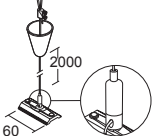



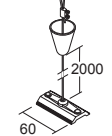



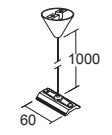







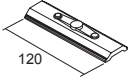

		7600-00	Adattatore elettromeccanico 6A, portata 10kg Electro/mechanical adapter 6A, load 10kg	20 30 31	$\neq 850^\circ$
		7601-00-W	Adattatore elettromeccanico 6A, portata 5kg Electro/mechanical adapter 6A, load 5kg	20 30 31	$\neq 850^\circ$
		7652-10-W	Alimentazione destra Right live-end	20 30 31	$\neq 850^\circ$
		7652-11-W	Alimentazione sinistra Left live-end	20 30 31	$\neq 850^\circ$
		7653-10-W	Alimentazione centrale e giunto lineare Central connector and straight joint	20 30 31	$\neq 850^\circ$

Accessori LKM quadro
 Square LKM accessories

		7655-10-W	Giunto L interno Inside L joint	20 30 31	$\neq 850^\circ$
		7655-11-W	Giunto L esterno Outside L joint	20 30 31	$\neq 850^\circ$
		7656-10-W	Giunto T destro Right T joint	20 30 31	$\neq 850^\circ$
		7656-11-W	Giunto T sinistro Left T joint	20 30 31	$\neq 850^\circ$
		7657-10-W	Giunto X X joint	20 30 31	$\neq 850^\circ$
		7658-10-W	Giunto flessibile Flexible joint	20 30 31	$\neq 850^\circ$

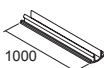

Accessori LKM quadro
Square LKM accessories

		7660-00-W	Giunto mobile Mobile joint				
		7654-10-W	Giunto lineare con blocco senza contatti (solo meccanico) Mechanical straight joint with stop				
		7604Q-10-W	Giunto lineare con contatti e con blocco Electrical straight joint with stop				
		7625-00	Adattatore meccanico Mechanical adapter				
		7618-00	Adattatore meccanico con bloccacavo Mechanical adapter with automatic locking				
		7617-00	Adattatore meccanico con gancio Mechanical adapter with hook				
		7606-05	Kit sospensione con cavo acciaio mm 2000 e piattina mm 120 Suspension kit with steel wire mm 2000 and mm 120 plate				
		7606-06	Kit sospensione con cavo acciaio mm 2000, piattina mm 60 e bloccacavo automatico Suspension kit with steel wire mm 2000, mm 60 plate and automatic locking device				
		7606-00	Kit sospensione con cavo acciaio mm 2000 e piattina mm 60 Suspension kit with steel wire mm 2000 and mm 60 plate				
		7626-00-00	Kit sospensione con tige mm 1000 e rosone traslucido Suspension kit with pipe mm 1000 and translucent ceiling base				
		7659-00-W	Terminale di chiusura Dead end				
		7606-04-00	Piattina mm 120 Plate mm 120				
		7609-00-00	Raccordo per adattatore elettromeccanico M10x1 Nut for electro/mechanical adapter M10x1				
		7607-00-00	Kit attacco soffitto Ceiling kit				
		7624-00	Copertura binario mm 1000 Track cover mm 1000				

LKM

INCASSO/RECESSED

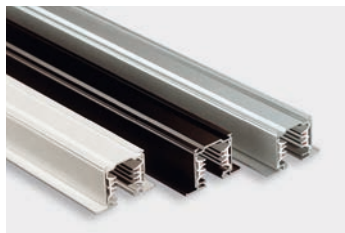

31 Bianco
White

30 Nero
Black

42 Anodizzato naturale
Satin silver

Codice Code	Lunghezza (mm) Length (mm)
7512-10	1000
7512-20	2000
7512-30	3000
7512-40	4000

Binario trifase LKM da incasso
LKM 3-phase recessed track

230V/440V-16A



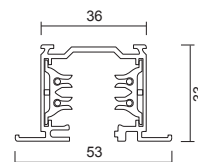











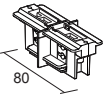



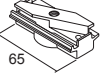



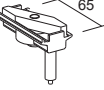







CE      IP20



Adattatori e alimentatori
 Adapters and live-ends

		7600-00	Adattatore elettromeccanico 6A, portata 10kg Electro/mechanical adapter 6A, load 10kg		
		7601-00-W	Adattatore elettromeccanico 6A, portata 5kg Electro/mechanical adapter 6A, load 5kg		
		7662-10-W	Alimentazione destra Right live-end		
		7663-10-W	Alimentazione centrale e giunto lineare Central connector and straight joint		

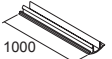
Accessori LKM incasso
 Recessed LKM accessories

		7604-10-W	Giunto lineare con contatti Electrical straight joint		
		7654-10-W	Giunto lineare con blocco senza contatti (solo meccanico) Mechanical straight joint with stop		
		7625-00	Adattatore meccanico Mechanical adapter		
		7618-00	Adattatore meccanico con bloccacavo Mechanical adapter with automatic locking		
		7664-00-48	Sospensione per controsoffitto Suspension for false ceiling		
		7659I-00-W	Terminale di chiusura Dead end		
		7609-00-00	Raccordo per adattatore elettromeccanico M10x1 Nut for electro/mechanical adapter M10x1		
		7607-00-00	Kit attacco a soffitto Ceiling kit		
		7624-00	Copertura binario mm 1000 Track cover mm 1000		



MM

Monofase/Single-phase

Mini Main è un sistema di binari elettrificati monofase di facile installazione, compatibile con molti proiettori della collezione Ivela.
Alimentazione alla rete monofase 230-250V, carico complessivo di 16A corrispondente a 3680/4000W.

Mini Main is a single-phase electrified track system, easy to install and compatible with many spotlights of the Ivela range. Connection to single phase 230-250V mains, total load of 16A corresponding to 3680/4000W.

SCHEMA ELETTRICO

Il collegamento alla rete elettrica monofase 230/250V consente un carico complessivo di 16A che corrisponde a 3680/4000 Watt.

WIRING DIAGRAM

Connection to single-phase 230/250V mains allows a total load of 16A, corresponding to 3680/4000 Watt.

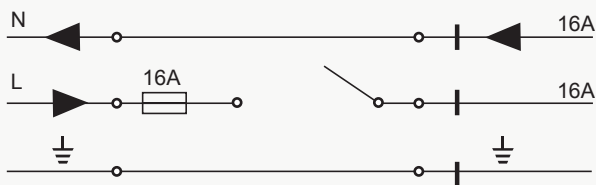

CAPACITÀ DI CARICO

Il binario può sopportare un carico di 4 Kg ogni 1000 mm.

The track has a load capacity of 4 Kg every 1000 mm.

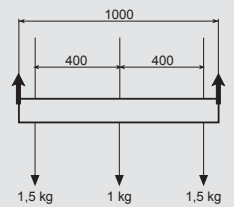

LOAD CAPACITY

Nel caso di carico di 7 Kg, la distanza di fissaggio deve essere di 500 mm.

For a 7 Kg load a maximum fixing distance of 500 mm is recommended.

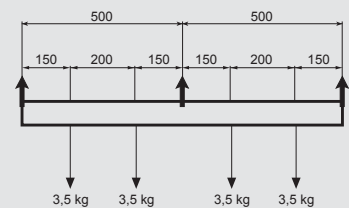

MM



- 31 Bianco
White
- 30 Nero
Black
- 42 Anodizzato naturale
Satin silver

Codice Code	Lunghezza (mm) Length (mm)
Binario monofase MM MM single-phase track	
7701-10	1000
7701-15	1500
7701-20	2000
7701-30	3000

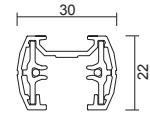

230/250V-16A



Accessori MM
MM accessories

4		7802-00-W	Alimentazione Live-end	20 30 31	$\neq 850^\circ$
6		7803-00-W	Alimentazione centrale Central connector	20 30 31	$\neq 850^\circ$
10		7800-00	Adattatore elettromeccanico 6A, portata 5kg Electro/mechanical adapter 6A, load 5kg	20 30 31	$\neq 850^\circ$
10		7825-00	Adattatore meccanico Mechanical adapter	30 31 52	$\neq 850^\circ$
2		7805-00-W	Giunto L L joint	20 30 31	$\neq 850^\circ$
2		7810-00-W	Giunto flessibile Flexible joint	30 31	$\neq 850^\circ$
6		7804-00-W	Giunto lineare con contatti Electrical straight joint	30 31	$\neq 850^\circ$
		7819-00-W	Giunto lineare senza contatti Mechanical joint	30 31	$\neq 850^\circ$
10		7806-00	Kit sospensione con cavo acciaio mm 2000 e piastrina mm 56 Suspension kit with steel wire mm 2000 and mm 56 plate	30 31	$\neq 850^\circ$
50		7807-02-W	Kit soffitto/parete a coppia Wall/ceiling pair	30 31	$\neq 850^\circ$
10		7823-00-W	Terminale di chiusura Dead end	20 30 31	$\neq 850^\circ$





ELV

Bassa tensione/Low voltage

Light Kit E.L.V. è un binario a bassa tensione di grande versatilità per molteplici soluzioni illuminotecniche e d'arredo, grazie agli spot applicabili con adattatore con attacco a Jack.

È prodotto in lega d'alluminio estruso verniciato in poliesteri o anodizzato naturale.

I conduttori elettrici sono alloggiati in una guaina estrusa di PVC all'interno del binario.

E' compresa una serie di accessori che consente il collegamento meccanico ed elettrico a più binari.

Light Kit E.L.V. is a highly versatile low voltage track, ideal for a number of technical and decorative applications, thanks to the spotlights that can be used with the Jack adapter.

It is manufactured in extruded aluminium alloy, polyester painted or anodized.

The copper electrical wires are located inside extruded PVC sheaths within the track.

The system includes a range of accessories for mechanical and electrical connection of tracks in rows.

CAPACITÀ DI POTENZA

La lunghezza complessiva del circuito (L max) determina la disponibilità di potenza (P Watt) per un corretto utilizzo e funzionamento degli apparecchi.

POWER CAPACITY

The overall length of the circuit (L max) determines the maximum power (P Watt) for a correct use and functioning of the fittings.

L max (mt.)	P (Watt)	I (Ampere)
5	300	25
7	250	20,8
9	200	16,6
11	150	12,5
13	100	8,3

CAPACITÀ DI CARICO

Capacità di portata per metro lineare.

LOAD CAPACITY

Load capacity per linear metre.

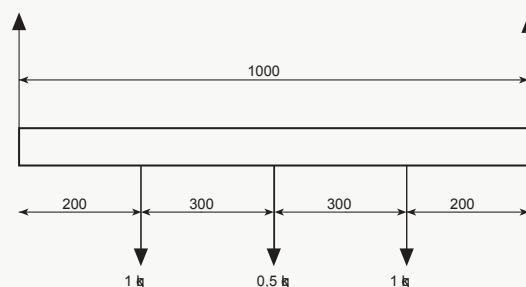

LIGHT KIT E.L.V.

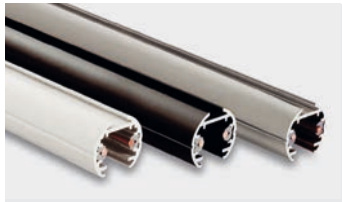
31 Bianco
White30 Nero
Black42 Anodizzato naturale
Satin silverCodice
CodeLunghezza (mm)
Length (mm)Binari a bassa tensione
Low voltage tracks

6501-10	1000
6501-20	2000
6501-30	3000

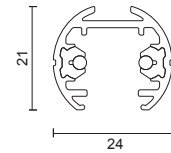

12V-25A

IP20

Accessori E.L.V.
E.L.V. accessories

10		6602-00	Alimentazione Live-end	30 31	
5		6603-00	Alimentazione centrale Central connector	30 31	
25		6604-00	Giunto lineare Straight connector	30 31	
25		6619-10	Giunto lineare senza contatti Mechanical connector	30 31	
5		6605-00	Giunto L L joint	30 31	
12		6610-00	Giunto flessibile Flexible joint	30 31	
10		6601-00	Adattatore a Jack 12V-5A (M10x1,5) - portata 1Kg Jack adapter 12V-5A - load 1Kg (M10x1,5)	30 31	
10		6620-00	Adattatore 12V-5A per cavo/tige (M10x1) - portata 1Kg Cable/pipe adapter 12V-5A - load 1Kg (M10x1)	30 31	
10		6620-10	Adattatore 12V-5A per cavo/tige (M8x1) - portata 1Kg Cable/pipe adapter 12V-5A - load 1Kg (M8x1)	30 31	
10		6606-00	Kit sospensione con cavo acciaio mm 2000 Suspension kit with steel wire mm 2000	30 31	
10		6607-20	Attacco soffitto/parete (set 2pz.) Ceiling/wall mounting kit (set 2pc.)	30 31	
		6650-03	Trasformatore elettronico 30/150W 30/150W electronic transformer	30 31	
10		6623-00	Chiusura Dead end	30 31	
10		6624-00	Copertura binario 1000 mm Track cover 1000 mm	30 31	

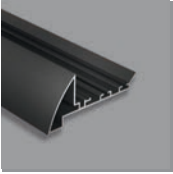

Broadway
p.108

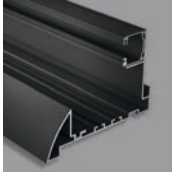

Broadway
p.108



Stripled 24V
p.109



Miniperfetto Broadway
p.110



Perfetto Broadway
p.111

Lighting Systems





Broadway

Studio Tecnico Ivela

Broadway è un sistema di illuminazione da interni per applicazione in controsoffitti di cartongesso, che consente l'installazione di apparecchi a scomparsa, creando al contempo un effetto di continuità luminosa.

L'illuminazione diventa completamente integrata:

Broadway offre un ampio ventaglio di possibilità progettuali, grazie ad una gestione flessibile e dinamica del posizionamento delle sorgenti luminose.

Ideale per applicazioni nell'ambito del retail e dell'hospitality, così come in esposizioni d'arte e musei. I proiettori possono essere installati anche senza binari ancorandoli direttamente alla superficie, per particolari applicazioni come su cornicioni di chiese o gallerie.

Broadway is an indoor lighting system for application in plasterboard false-ceilings, allowing both the installation of concealed fittings, and creating an effect of luminous continuity at the same time.

Lighting becomes wholly integrated: **Broadway** grants a wide range of project applications, thanks

to a flexible and dynamic positioning of the luminous sources. Ideal for applications in retail and hospitality, as well as in art exhibitions and museums. The spotlights can be installed also without tracks by anchoring them directly to the surface, for particular applications such as on cornices of churches and galleries.



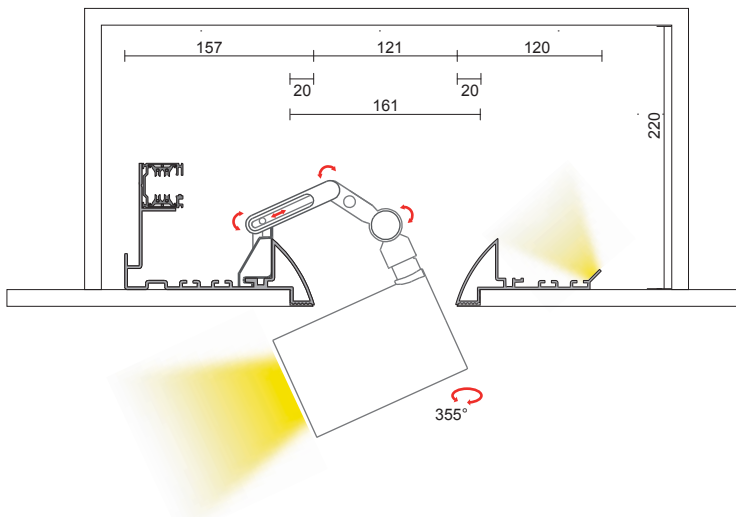
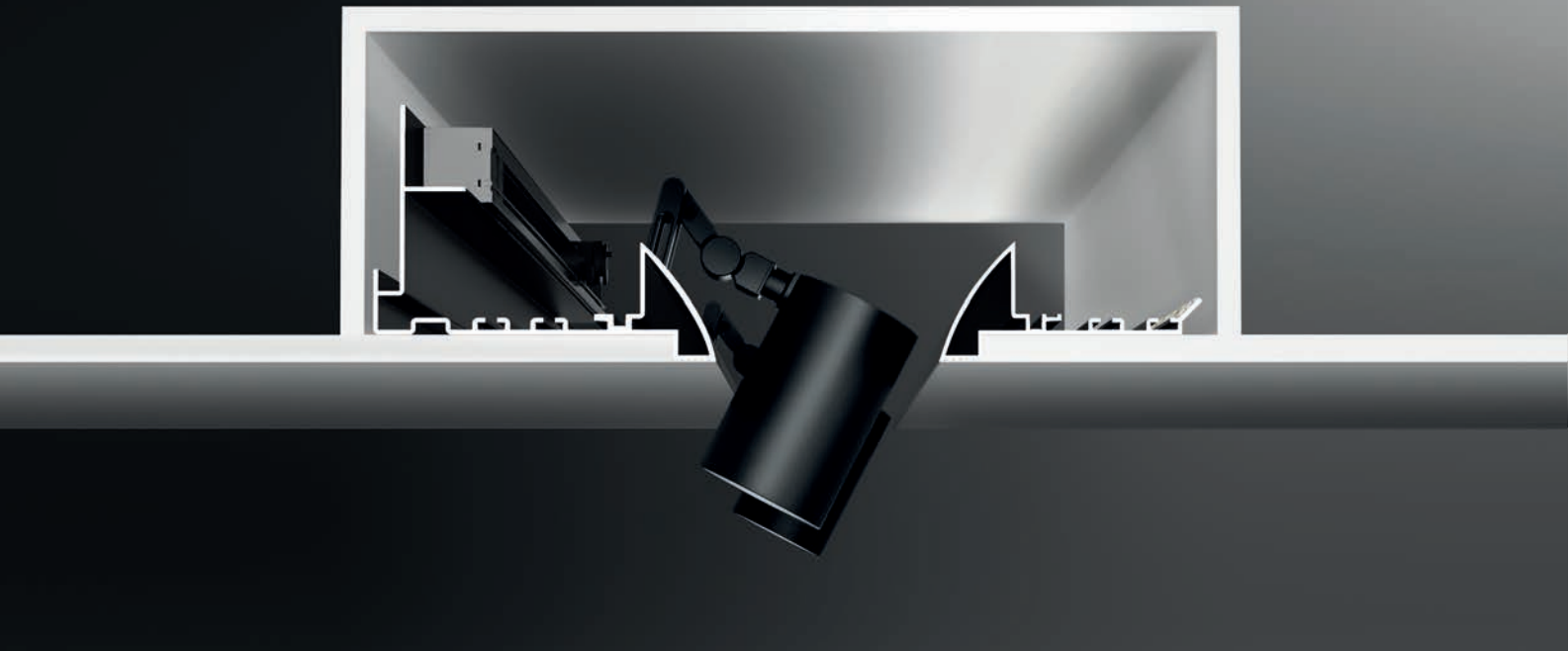

Sezione trasversale del sistema Broadway con binario elettrificato, proiettore Perfetto in posizione esterna e striped.

Cross section of Broadway system with electrified track, Perfetto spotlight in external position and striped.



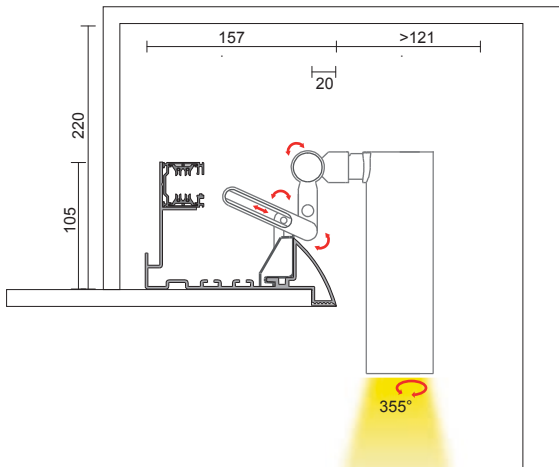
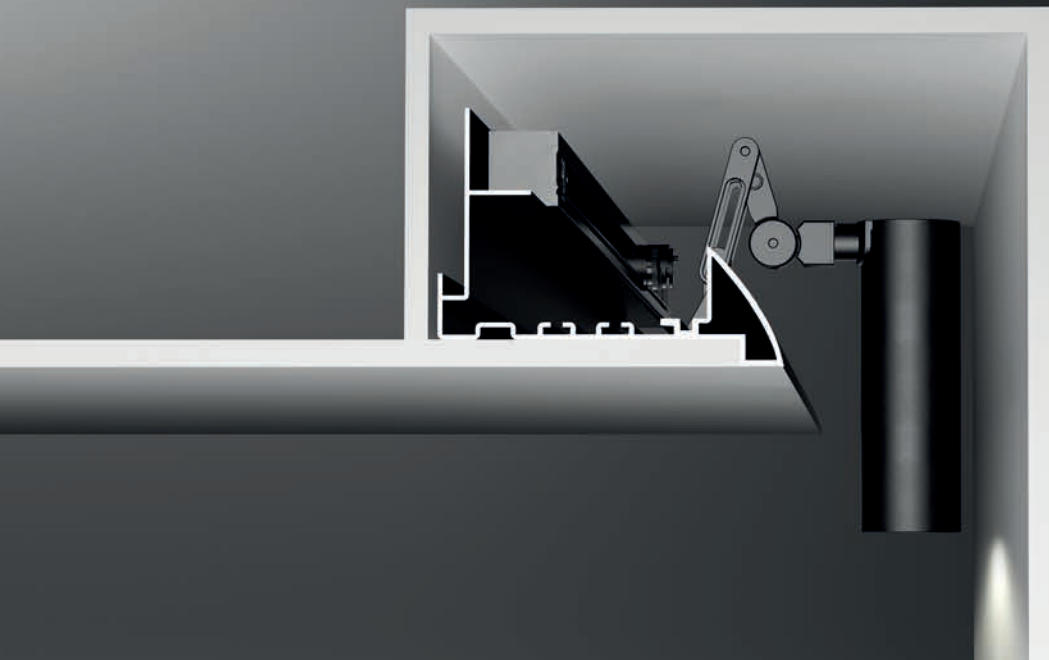

Sezione trasversale del sistema Broadway in applicazione perimetrale con binario elettrificato e proiettore Miniperfetto in posizione interna.

Cross section of Broadway system in perimetric application with electrified track, Miniperfetto spotlight in internal position.

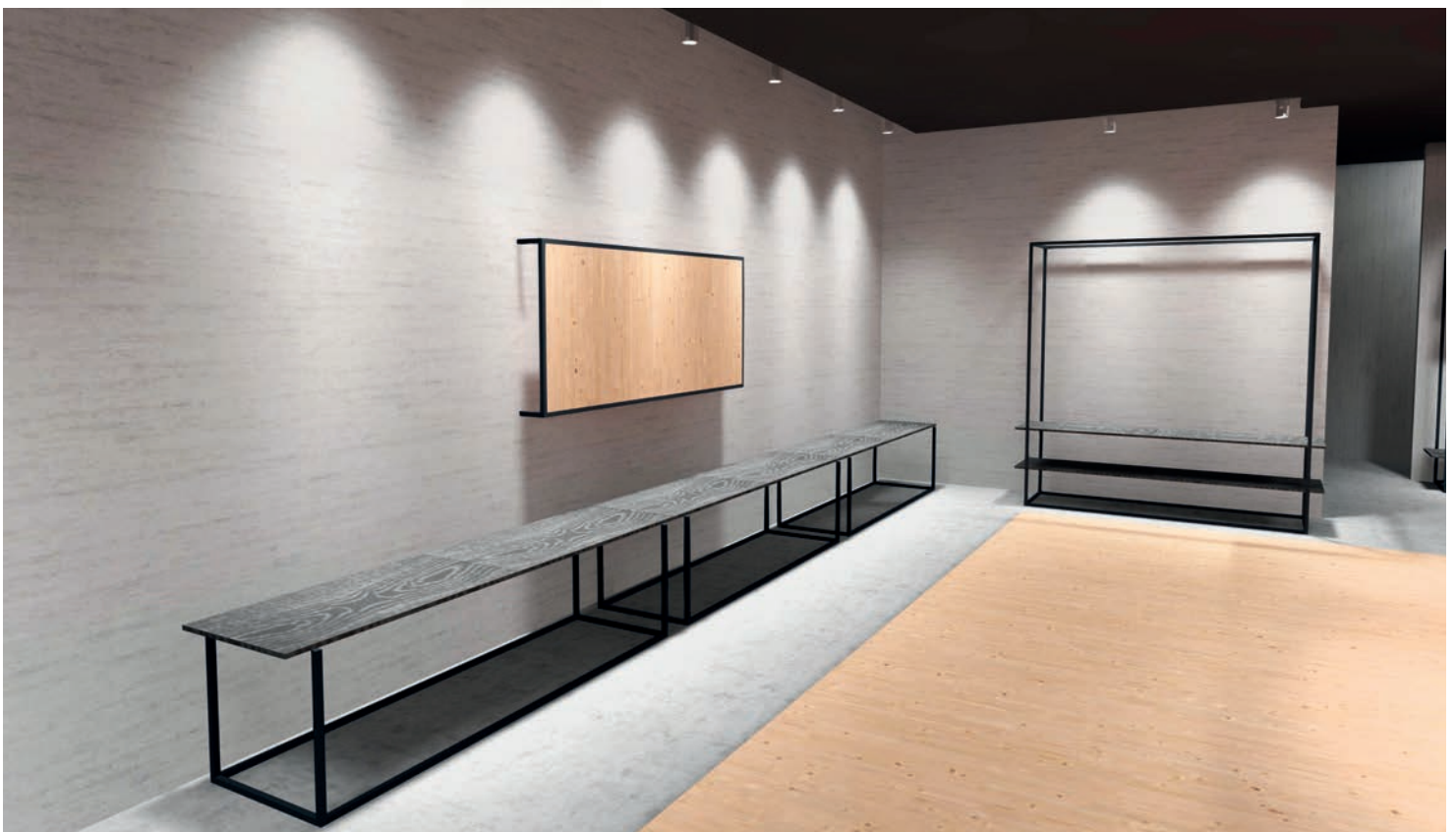

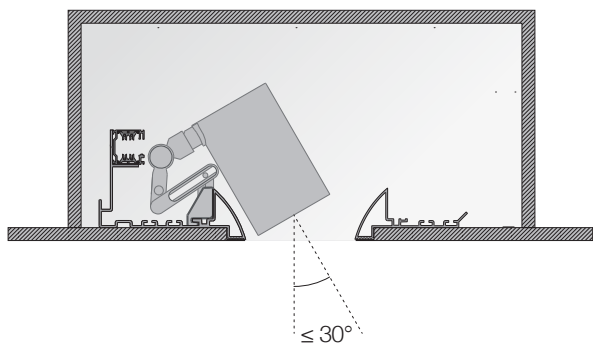
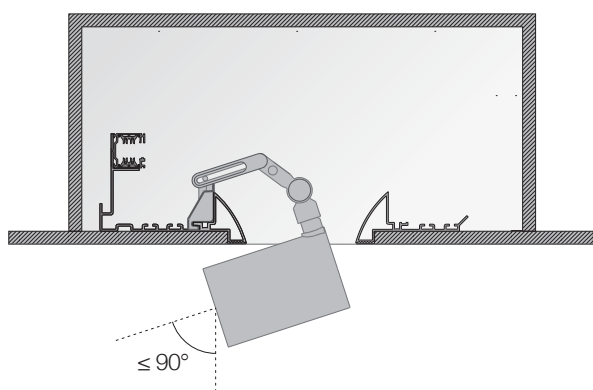

Broadway è costituito da due misure di profili in alluminio estruso in finitura nera, con o senza binario elettrificato trifase quadro. Sul binario si posizionano, tramite un innovativo sistema di ancoraggio a slitta, proiettori con sorgenti luminose LED COB di ultima generazione e di due diverse dimensioni. Grazie al sistema di fissaggio gli apparecchi possono essere installati o riposizionati facilmente.

I proiettori sono facili da installare nei profili con binario grazie al sistema di ancoraggio a slitta.

Questo sistema di fissaggio consente di riposizionare, sostituire o aggiungere apparecchi senza difficoltà.

I proiettori sono caratterizzati da un braccetto con triplo snodo, che permette movimenti cardanici su tutti gli assi, oltre all'orientamento della testa di 355°.

I proiettori Perfetto e Miniperfetto, contraddistinti da un design cilindrico dalle linee semplici ed eleganti, sono progettati per ospitare LED COB ad alta efficienza per elevate prestazioni.

Broadway consists of two sizes of extruded aluminium profiles, in black finish, with or without a 3-phase electrified square track.

The spotlights, available in two sizes and equipped with the last generation of COB LEDs, can be anchored to the track through an innovative slide fixing system.

Due to this anchoring system, the light fixtures can be easily installed and repositioned.

Spotlights easy to be installed in the profiles with tracks, thanks to the specific slide anchoring system.

This fixing system allows to reposition, change or add spotlights easily.

The fittings feature an adjustable arm with triple junction, that allows cardan movements on both axes, in addition to the 355° orientation of the head.

Perfetto and Miniperfetto spotlights, featuring cylindrical design with simple and elegant lines, are designed for high efficiency COB LEDs, for a high performance.



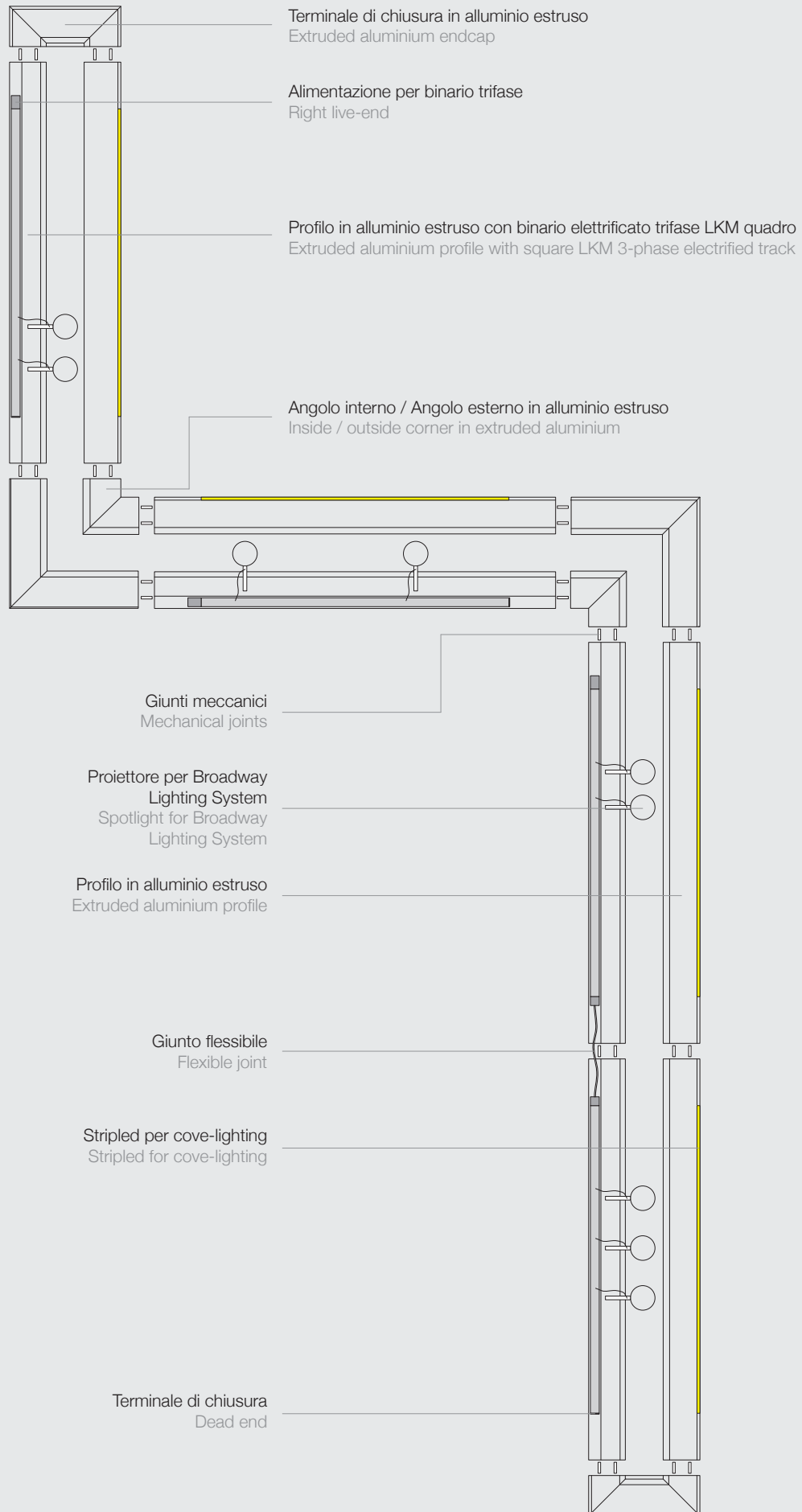

BROADWAY



Codice Code	Lunghezza (mm) Length (mm)	Kg.
----------------	-------------------------------	-----

Profilo in alluminio estruso
Extruded aluminium profile

7842-13	1300	3,5
7842-23	2300	6,1

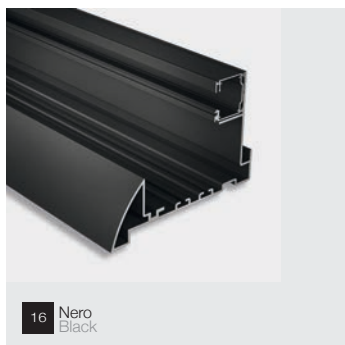
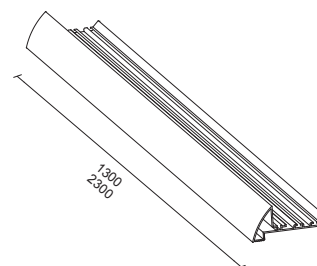
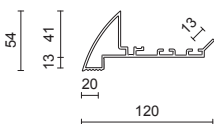

Profilo in alluminio estruso con binario elettrificato trifase LKM quadro
Extruded aluminium profile with square LKM 3-phase electrified track

7841-13	1300	Binario / Track 1000 mm	4,4
7841-23	2300	Binario / Track 2000 mm	7,9

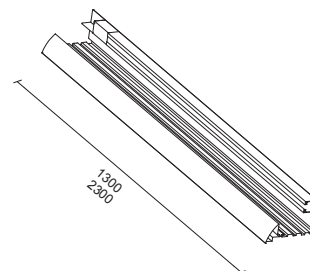
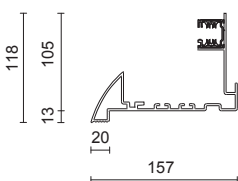

Terminale di chiusura in alluminio estruso
Extruded aluminium endcap

7850-00		0,7
----------------	--	-----

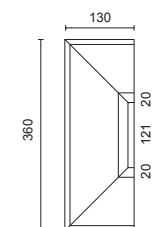

Angolo interno / Angolo esterno in alluminio estruso
Inside / Outside corner in extruded aluminium

7850I-00	Interno / Inside	0,4
7850E-00	Esterno / Outside	2,1

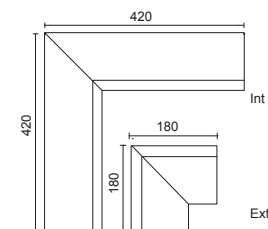

7851-00-00	Giunto meccanico (Kit da 4 pezzi) Mechanical joint (4 pieces kit)
-------------------	--



STRIPLED 24V



Codice Code	Watt/mt	Lumen/mt	LED/mt	Colour T (K)	CRI	Fascio Beam
Bobina 5 mt. 5 mt. Coil						
93-9WB-0715F	9,6	715	120	3000	85	120°
93-9WA-0715F	9,6	715	120	4000	85	120°

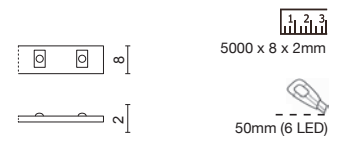

CE IP33 **A++ A+ A**

Driver da ordinare separatamente
Driver should be ordered separately



91-90039

50W

Tensione costante 24VDC
24VDC constant voltage

Accessori per binario trifase
LKM quadro
Accessories for LKM 3-phase
square track

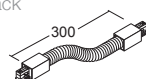

7658-10-W

Giunto flessibile
Flexible joint

30



7659-00-W

Terminale di chiusura
Dead end

30

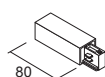

7652-10-W

Alimentazione destra
Right live-end

30

7652-11-W

Alimentazione sinistra
Left live-end

MINIPERFETTO BROADWAY



16 Nero Black

Codice Code	LED Lumen	Product Lumen	Watt	Colour T (K)	CRI	Fascio Beam
5 apparecchi per ogni profilo da 1300mm/10 apparecchi per ogni profilo da 2300mm 5 fittings for each 1300mm profile/10 fittings for each 2300mm profile						
749-261	2400	2136	18	3000	85	30°
749-261A	2450	2181	18	4000	85	30°

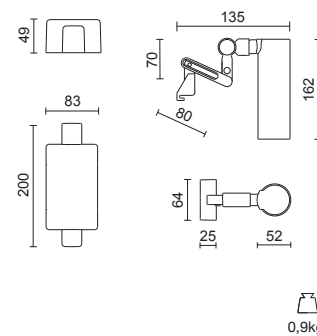

220/240V - 50/60Hz

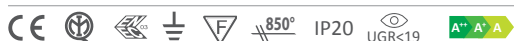

Accessori ottici intercambiabili Replaceable optical accessories



28-3901-51

Ottica professionale S
Professional optic device S

18W



28-3902-51

Ottica professionale M
Professional optic device M



28-3903-51

Ottica professionale W
Professional optic device W



28-3979-100

Cilindro antiabbagliamento dorato
Golden snoot



28-3905-47

Schermo di chiusura in termoplastico trasparente
Closing screen in clear thermoplastic material

* Accessorio da utilizzare esclusivamente insieme a cod. 28-3905-47



28-4022-30*

Frangiluce alveolare
Honeycomb

* Accessory to be used only with code 28-3905-47



PERFETTO BROADWAY



16 Nero Black

Codice Code	LED Lumen	Product Lumen	Watt	Colour T (K)	CRI	Fascio Beam
Max 5 apparecchi ogni 1000 mm di binario Max 5 fittings for each 1000 mm of track						
745-161	3100	2759	26	3000	85	25°
745-161A	3250	2893	26	4000	85	25°
Max 4 apparecchi ogni 1000 mm di binario Max 4 fittings for each 1000 mm of track						
745-361	4850	4317	38	3000	85	30°
745-361A	5050	4495	38	4000	85	30°

220/240V - 50/60Hz

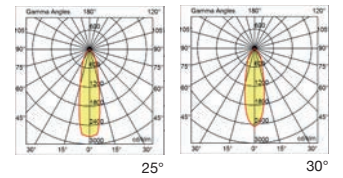
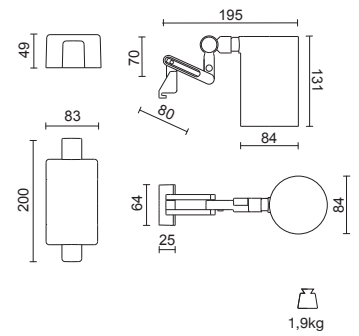
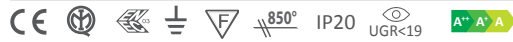

Accessori ottici intercambiabili Replaceable optical accessories



28-3140-51

Ottica professionale S
Professional optic device S

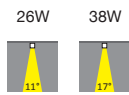

28-3142-51

Ottica professionale M
Professional optic device M



28-3138-51

Ottica professionale W
Professional optic device W



28-3141-31

Ottica professionale XW
Professional optic device XW

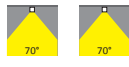

28-3957-30

Cilindro antiabbagliamento
Snoot



28-3959-30*

Frangiluce alveolare
Honeycomb



28-3958-58*

Vetro temperato trasparente
Clear tempered glass



28-3958-32*

Vetro temperato con filtro food rosato
Pink tempered glass for food application

* Accessori da utilizzare esclusivamente insieme a snoot cod. 28-3957-30

* Accessories to be used only with snoot code 28-3957-30



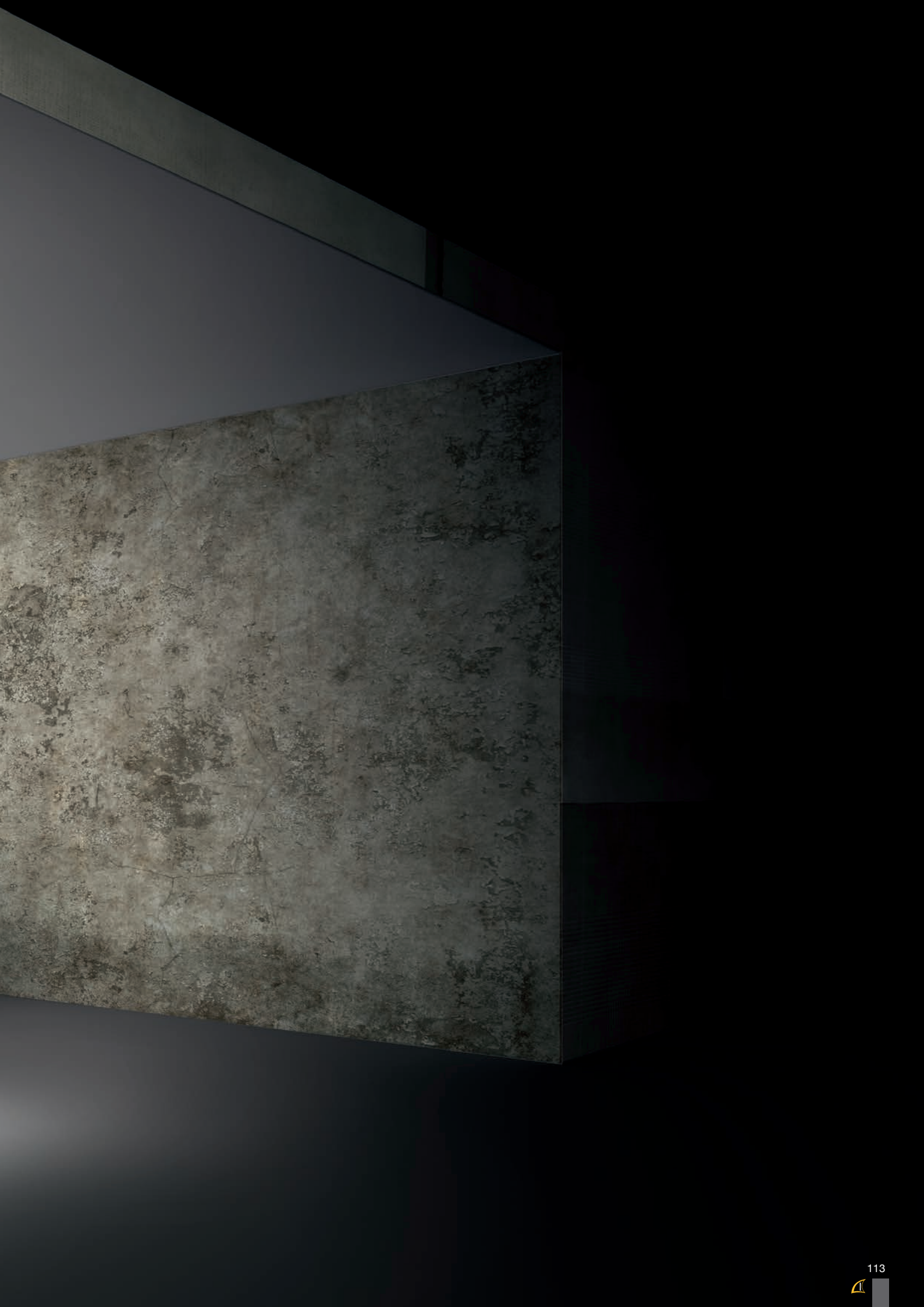



RA 4
p.117



RA 4 con lente
with lens
p.117

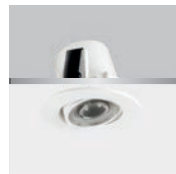

RA 4 adjustable
con lente/with lens
p.117



RA 8 L Dixit LED
p.122



RA 8 Dixit LED
p.122



RA 8 L Dixit LED
IP65
p.123



RA 8 Dixit LED
IP65
p.123



RA 8 L Q Dixit LED
p.124



RA 8 Q Dixit LED
p.124



RA 8 L TL Dixit LED
p.125



RA 8 TL Dixit LED
p.125



RA 8 Soft Dixit LED
p.127



RA 8 L adjustable
Dixit LED
p.128



RA 8 adjustable
Dixit LED
p.128



RA 8 adjustable
Dixit LED IP65
p.129



RA 11 Dixit LED
p.134



RA 11 Q Dixit LED
p.135



RA 11 TL Dixit LED
p.136



RA 11 Soft
Dixit LED
p.137



RA 11 adjustable
Dixit LED
p.138



RA 14 Dixit LED
p.140



RA 16
p.141



RA 17 Dixit LED
p.142



RA 18 Dixit LED
p.143



RA 20 Dixit LED
p.144

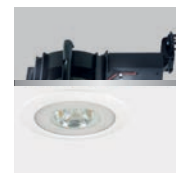

RA 20 WW Dixit LED
p.144

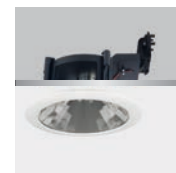

RA 23 S Dixit LED
p.145

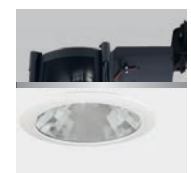

RA 23 SP Dixit LED
p.145



DJ
p.146

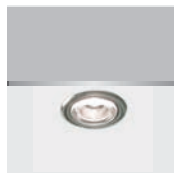

DJ con anello
with ring
p.146



RA 7
p.147

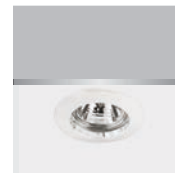

Deco
p.148



Incassi

DOWNLIGHTS

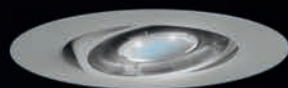

RA 4

Studio Tecnico Ivela

RA 4 è una gamma di incassi progettati per fonti luminose LED COB di ultima generazione. Caratterizzati da una profondità di incasso estremamente ridotta, gli apparecchi possono essere installati facilmente in controsoffitti da 1 a 30 mm.

RA 4 è disponibile in versione fissa, oscillante e con lente per fascio 14°.

RA 4 nelle varie versioni, è ideale per l'illuminazione sia diffusa che d'accento, in ambiti residenziali o espositivi. Gli incassi possono essere forniti, su richiesta, con altri fasci (30°/50°/60°).

Il LED driver a corrente costante 500mA da 20W deve essere ordinato separatamente.

Materiali:

- Corpo e anello in pressofusione di alluminio, verniciato poliesteri
- Schermo di chiusura in policarbonato trasparente
- Lente fascio 14°

RA 4 is a range of downlights, designed for the last generation of COB LED sources.

It is characterized by an extremely shallow recessed depth: the fitting can be installed easily in false ceilings from 1 to 30 mm.

RA 4 is available in fixed or tiltable version, also with a lens for 14° beam.

RA 4 is ideal both for diffused and for accent lighting in residential or in display areas.

The downlights can be supplied, on demand, with other beams (30°/50°/60°).

The 500mA 20W constant current LED driver should be ordered separately.

Materials:

- Body and bezel in die-cast aluminium, polyester painted
- Closing screen in clear polycarbonate
- Lens for 14° beam

Modello di design depositato / Registered design model



RA 4



21 Bianco mat
Mat white

Codice Code	LED Lumen	Product Lumen	Watt	Colour T (K)	CRI	Fascio Beam
252-200	540	320	4,6	3000	85	60°

Max 4 apparecchi collegabili al driver da ordinare separatamente (cod. 81-04019)
Max 4 fittings can be connected to the driver (cod. 81-04019), to be ordered separately

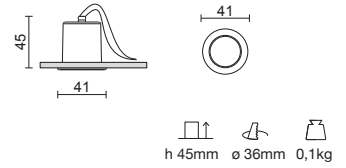

h 45mm ø 36mm 0,1kg

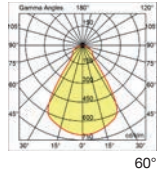

60°

RA 4 CON LENTE WITH LENS



21 Bianco mat
Mat white

252-210	200	-	2	3000	85	14°
----------------	-----	---	---	------	----	-----

Max 8 apparecchi collegabili al driver da ordinare separatamente (cod. 81-04019)
Max 8 fittings can be connected to the driver (cod. 81-04019), to be ordered separately

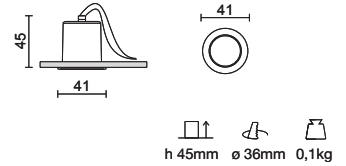

h 45mm ø 36mm 0,1kg

RA 4 OSCILLANTE CON LENTE ADJUSTABLE WITH LENS



21 Bianco mat
Mat white

253-210	200	-	2	3000	85	14°
----------------	-----	---	---	------	----	-----

Max 8 apparecchi collegabili al driver da ordinare separatamente (cod. 81-04019)
Max 8 fittings can be connected to the driver (cod. 81-04019), to be ordered separately

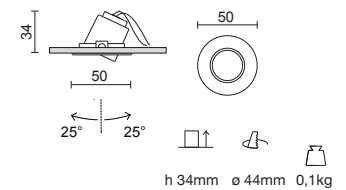

h 34mm ø 44mm 0,1kg

Driver da ordinare separatamente
Driver should be ordered separately



81-04019

20 W

Corrente costante - Output 500mA
Constant current - Output 500mA



RA 8 Dixit Led

Studio Tecnico Ivela

La gamma di incassi **RA 8 Dixit LED**, è stata progettata per soddisfare le più diverse esigenze illuminotecniche, in particolare per l'applicazione in centri commerciali, negozi e uffici.

La serie **RA 8 Dixit LED** è particolarmente ricca di varianti ed è disponibile in differenti versioni: con cornice tonda o quadra, con ottica fissa o oscillante, a ridotta profondità di incasso, senza cornice (trimless o soft) e per l'esterno con grado di protezione IP65.

Tutte le versioni della gamma prevedono ottiche professionali in termoplastico metallizzato a specchio, che offrono un'elevata qualità della luce e un eccellente mantenimento dell'intensità luminosa nel tempo.

L'elevato rendimento luminoso di **RA 8 Dixit LED** si coniuga con contenuti valori di luminanza ed estremamente bassi livelli di abbagliamento UGR<15, consentendo un ottimo comfort visivo.

RA 8 Dixit LED, con LED COB ad alta efficienza, è disponibile con due diverse temperature di colore: 3000K e 4000K e accessoriabile con ottiche professionali intercambiabili per fasci luminosi differenti. I driver sono da ordinare separatamente, la potenza dell'apparecchio varia a seconda del driver scelto.

Materiali:

- Corpo e anello in pressofusione di alluminio, verniciato poliestere
- Ottiche professionali in termoplastico metallizzato a specchio
- Schermo di chiusura in polycarbonato trasparente

The downlights **RA 8 Dixit LED** have been developed to meet the widest range of requirements in lighting design, focusing on key-applications such as retail, shopping centers and offices.

RA 8 Dixit LED range offers a complete selection of versions: with round or square bezel, fixed or adjustable, with low recessed height, trimless or soft, and with IP65 protection rating for outdoor.

The whole range is supplied with professional optics in thermoplastic material, mirror-metallized, that ensure a high quality of the light and an excellent stability of the luminous flux over time.

The high efficiency of **RA 8 Dixit LED** is associated to low luminance and very low glare levels UGR<15, for an excellent visual comfort.

RA 8 Dixit LED, with high efficiency COB LEDs, is available with two different color temperatures: 3000K or 4000K. The fittings can be supplied with interchangeable optics for different light beams. LED drivers should be ordered separately, the wattage of the fittings changes, depending on the selected driver.

Materials:

- Body and bezel in die-cast aluminium, polyester painted
- Professional optics in thermoplastic material, mirror metallized
- Closing screen in clear polycarbonate

Modelli di design depositato / Registered design models

Range RA 8 Dixit LED



RA 8 Dixit LED sono disponibili in 35 versioni tra incassi con molle, a filo cartongesso, ottica fissa, orientabile e soft. Una gamma di apparecchi completa che copre ogni esigenza di illuminazione in negozi, esposizioni e luoghi di lavoro.

RA 8 Dixit LED are available in 35 versions: with springs, trimless, fixed / adjustable optics and soft finish. A complete range of fittings for every lighting need in shops, exhibition areas and workplaces.

TIPOLOGIE DI OTTICHE

Ottica Fissa

Gli incassi ad ottica fissa sono ideali per illuminare in modo uniforme molteplici ambienti quali uffici, strutture ricettive e di intrattenimento, locali di lavoro in generale ma anche negozi e centri commerciali.

La varietà di fasci di luce degli apparecchi ne permette l'utilizzo per illuminare in modo diretto e ben controllato piccole e grandi superfici.

Ottica Oscillante

Gli incassi con ottica oscillante permettono di controllare la direzione del flusso luminoso e di mettere in risalto oggetti o dettagli espositivi senza dispersioni di luce, esaltando i particolari con un'efficace illuminazione d'accento.

Finitura Trimless/Soft

La finitura a filo soffitto che caratterizza alcune versioni della gamma RA 8 Dixit LED è la scelta ottimale per mostrare la luce in modo morbido: la luce si integra perfettamente negli ambienti e ne diventa protagonista.

OPTIC TYPES

Fixed Optic

The downlights with a fixed optic are designed to supply a uniform light for applications such as offices, accommodation facilities, job spaces but also for retail and shopping centers.

The wide range of options available in terms of beams is ideal for the direct lighting of small and large surfaces, with an effective light control.

Adjustable Optic

The downlights with an adjustable optic allow to control the direction of the luminous flux, and to highlight objects or display elements without wasting light, while putting them under the right emphasis by means of an effective accent lighting.

Trimless/Soft Finish

Some versions of RA 8 Dixit LED range are characterized by a finish flush with the ceiling. This is the perfect choice to show the light in a softer way: the light is perfectly integrated in the environment and becomes the protagonist.



RA 8 L DIXIT LED



21 Bianco mat
Mat white

Codice Code	LED Lumen	Product Lumen	Watt	Colour T (K)	CRI	Fascio Beam
238-239BN	550	501	5,5	3000	90	26°
	700	638	8,5			
238-239AN	650	592	5,5	4000	90	26°
	800	729	8,5			

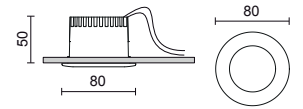

h 50mm ø 70mm 0,4kg



RA 8 DIXIT LED



21 Bianco mat
Mat white

238-250BN	1250	1096	9	3000	80	26°
	1650	1447	12			
238-250AN	1300	1140	9	4000	80	26°
	1700	1491	12			

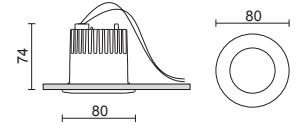

h 74mm ø 70mm 0,4kg

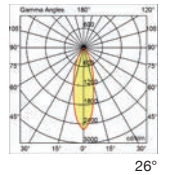

Driver da ordinare separatamente
Drivers should be ordered separately



81-04007	5,5 W	Output 350mA - Regolabile sul taglio di fase e 1-10V - Dimmable on the mains and 1-10V
81-04008	8,5 W	Output 500mA - Regolabile sul taglio di fase e 1-10V - Dimmable on the mains and 1-10V
81-04009	9 W	Output 250mA
81-04010	12 W	Output 350mA - Regolabile sul taglio di fase - Dimmable on the mains
81-04003	12 W	Output 350mA - Dimmerabile DALI - Dali dimmable

Accessori ottici intercambiabili
Replaceable optical accessories



28-3869-51 Ottica professionale M
Professional optic device M



28-3868-51 Ottica professionale W
Professional optic device W



28-3868-31 Ottica professionale XW
Professional optic device XW

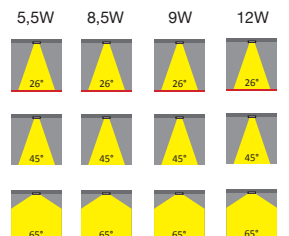

RA 8 L DIXIT LED IP65



73 Bianco / deflettore nero
White / black baffle

Codice Code	LED Lumen	Product Lumen	Watt	Colour T (K)	CRI	Fascio Beam
237-239BN	550	501	5,5	3000	90	26°
	700	638	8,5			

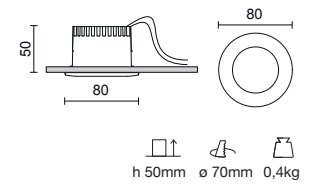

RA 8 DIXIT LED IP65



73 Bianco / deflettore nero
White / black baffle

237-250BN	1250	1096	9	3000	80	26°
	1650	1447	12			

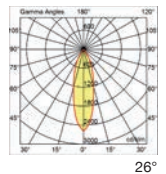
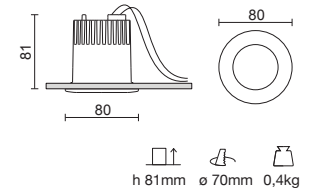

Driver da ordinare separatamente Drivers should be ordered separately		81-04007	5,5 W	Output 350mA - Regolabile sul taglio di fase e 1-10V - Dimmable on the mains and 1-10V
		81-04008	8,5 W	Output 500mA - Regolabile sul taglio di fase e 1-10V - Dimmable on the mains and 1-10V
		81-04009	9 W	Output 250mA
		81-04010	12 W	Output 350mA - Regolabile sul taglio di fase - Dimmable on the mains
		81-04003	12 W	Output 350mA - Dimmerabile DALI - Dali dimmable

Accessori ottici intercambiabili
Replaceable optical accessories



28-3869-51	Ottica professionale M Professional optic device M
28-3868-51	Ottica professionale W Professional optic device W
28-3868-31	Ottica professionale XW Professional optic device XW

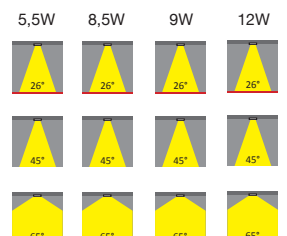

RA 8 L Q DIXIT LED



21 Bianco mat
Mat white

Codice Code	LED Lumen	Product Lumen	Watt	Colour T (K)	CRI	Fascio Beam
233-239BN	550	501	5,5	3000	90	26°
	700	638	8,5			
233-239AN	650	592	5,5	4000	90	26°
	800	729	8,5			

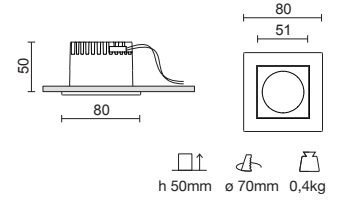

h 50mm ø 70mm 0,4kg



RA 8 Q DIXIT LED



21 Bianco mat
Mat white

233-250BN	1250	1096	9	3000	80	26°
	1650	1447	12			
233-250AN	1300	1140	9	4000	80	26°
	1700	1491	12			

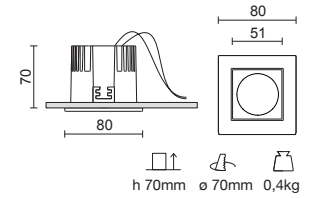

h 70mm ø 70mm 0,4kg

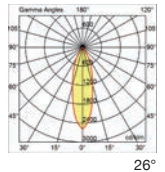

Driver da ordinare separatamente
Drivers should be ordered separately



81-04007	5,5 W	Output 350mA - Regolabile sul taglio di fase e 1-10V - Dimmable on the mains and 1-10V
81-04008	8,5 W	Output 500mA - Regolabile sul taglio di fase e 1-10V - Dimmable on the mains and 1-10V
81-04009	9 W	Output 250mA
81-04010	12 W	Output 350mA - Regolabile sul taglio di fase - Dimmable on the mains
81-04003	12 W	Output 350mA - Dimmerabile DALI - Dali dimmable

Accessori ottici intercambiabili
Replaceable optical accessories



28-3902-51	Ottica professionale M Professional optic device M
28-3903-51	Ottica professionale W Professional optic device W
28-3903-31	Ottica professionale XW Professional optic device XW

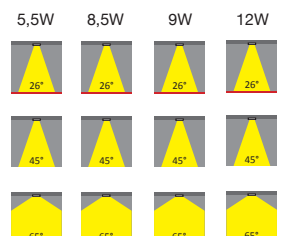

RA 8 L TL DIXIT LED



21 Bianco mat
Mat white

Codice Code	LED Lumen	Product Lumen	Watt	Colour T (K)	CRI	Fascio Beam
234-239BN	550	491	5,5	3000	90	26°
	700	637	8,5			

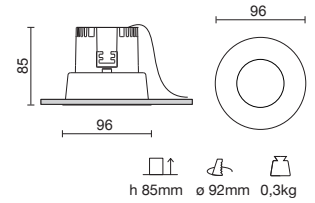

h 85mm ø 92mm 0,3kg

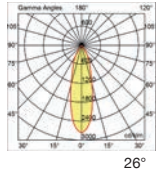

RA 8 TL DIXIT LED



21 Bianco mat
Mat white

234-259BN	1050	921	9	3000	90	26°
	1400	1228	12			

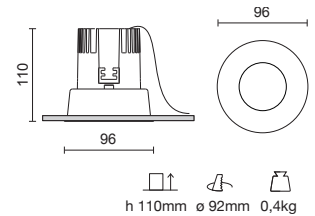

h 110mm ø 92mm 0,4kg

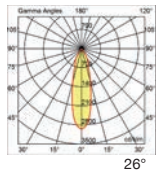

Driver da ordinare separatamente
Drivers should be ordered separately



81-04007	5,5 W	Output 350mA - Regolabile sul taglio di fase e 1-10V - Dimmable on the mains and 1-10V
81-04008	8,5 W	Output 500mA - Regolabile sul taglio di fase e 1-10V - Dimmable on the mains and 1-10V
81-04009	9 W	Output 250mA
81-04010	12 W	Output 350mA - Regolabile sul taglio di fase - Dimmable on the mains
81-04003	12 W	Output 350mA - Dimmerabile DALI - Dali dimmable

Accessori ottici intercambiabili
Replaceable optical accessories



28-3869-51	Ottica professionale M Professional optic device M
28-3868-51	Ottica professionale W Professional optic device W
28-3868-31	Ottica professionale XW Professional optic device XW

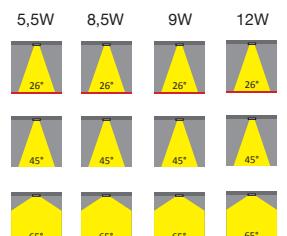



RA 8 SOFT DIXIT LED



21 Bianco mat
Mat white

Codice Code	LED Lumen	Product Lumen	Watt	Colour T (K)	CRI	Fascio Beam
238-039BN	1050	-	9	3000	90	26°
	1400	-	12			

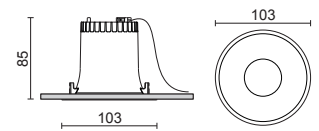

h 85mm ø 96mm 0,3kg

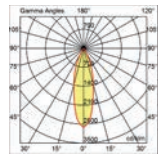

26°



Driver da ordinare separatamente
 Drivers should be ordered separately



81-04009	9 W	Output 250mA
81-04010	12 W	Output 350mA - Regolabile sul taglio di fase - Dimmable on the mains
81-04003	12 W	Output 350mA - Dimmerabile DALI - Dali dimmable



RA 8 L DIXIT LED OSCILLANTE/ADJUSTABLE



21 Bianco mat
Mat white

Codice Code	LED Lumen	Product Lumen	Watt	Colour T (K)	CRI	Fascio Beam
239-239BN	550	501	5,5	3000	90	26°
	700	638	8,5			
239-239AN	650	592	5,5	4000	90	26°
	800	729	8,5			

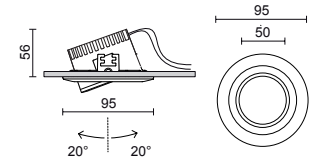

h 56mm ø 86mm 0,4kg



RA 8 DIXIT LED OSCILLANTE/ADJUSTABLE



21 Bianco mat
Mat white

239-250BN	1250	1096	9	3000	80	26°
	1650	1447	12			
239-250AN	1300	1140	9	4000	80	26°
	1700	1491	12			

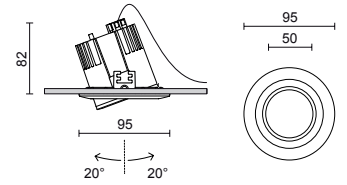

h 82mm ø 86mm 0,4kg

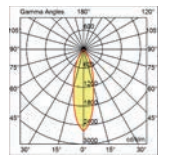

26°

Driver da ordinare separatamente
Drivers should be ordered separately



81-04007	5,5 W	Output 350mA - Regolabile sul taglio di fase e 1-10V - Dimmable on the mains and 1-10V
81-04008	8,5 W	Output 500mA - Regolabile sul taglio di fase e 1-10V - Dimmable on the mains and 1-10V
81-04009	9 W	Output 250mA
81-04010	12 W	Output 350mA - Regolabile sul taglio di fase - Dimmable on the mains
81-04003	12 W	Output 350mA - Dimmerabile DALI - Dali dimmable

Accessori ottici intercambiabili
Replaceable optical accessories



28-3869-51	Ottica professionale M Professional optic device M
28-3868-51	Ottica professionale W Professional optic device W
28-3868-31	Ottica professionale XW Professional optic device XW

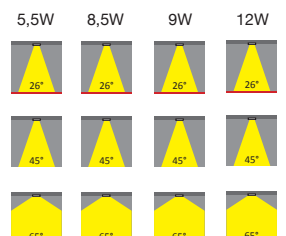

RA 8 DIXIT LED IP65

OSCILLANTE/ADJUSTABLE



21 Bianco mat
Mat white

Codice Code	LED Lumen	Product Lumen	Watt	Colour T (K)	CRI	Fascio Beam
235-250B	1650	1447	12	3000	80	26°

Su richiesta. LED driver incluso
On demand. LED driver included

220/240V - 50/60Hz

IP65 IK08

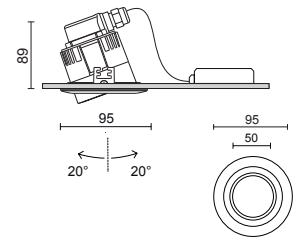

h 89mm ø 95mm 0,7kg

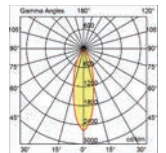

26°

Accessori ottici
intercambiabili
Replaceable optical
accessories



28-3869-51

Ottica professionale M
Professional optic device M

12W



28-3868-51

Ottica professionale W
Professional optic device W



28-3868-31

Ottica professionale XW
Professional optic device XW





RA 11 Dixit LED

Studio Tecnico Ivela

La gamma di incassi **RA 11 Dixit LED**, con LED COB di ultima generazione, è stata progettata per soddisfare le più diverse esigenze illuminotecniche, in particolare per l'applicazione in centri commerciali, negozi e uffici. Tutte le versioni della gamma, ottica fissa, oscillante, trimless e soft, prevedono ottiche professionali in termoplastico metallizzato a specchio, per un'elevata qualità della luce e un eccellente mantenimento dell'intensità luminosa nel tempo.

L'elevato rendimento luminoso di **RA 11 Dixit LED** si coniuga con contenuti valori di luminanza e bassi livelli di abbagliamento, consentendo un ottimo comfort visivo.

RA 11 Dixit LED è disponibile con due diverse temperature di colore: 3000K e 4000K.

Driver da ordinare separatamente, la potenza dell'apparecchio varia a seconda del driver scelto.

The downlights **RA 11 Dixit LED**, with COB LEDs of last generation, have been developed to meet the widest range of requirements in lighting design, focusing on key-applications such as retail, shopping centers and offices.

The whole range is supplied with professional optic devices in thermoplastic material, mirror-metallized, that ensure a high quality of the light and an excellent stability of the luminous flux over time. The high efficiency of **RA 11 Dixit LED** is associated to low luminance and low glare levels, for an excellent visual comfort.

RA 11 Dixit LED is available with two different color temperatures: 3000K or 4000K. LED drivers should be ordered separately, the wattage of the fittings changes, depending on the selected driver.



Range RA 11 Dixit LED



Materiali:

- Corpo e anello in pressofusione di alluminio, verniciato poliester
- Ottiche professionali in termoplastico metallizzato a specchio
- Schermo di chiusura in policarbonato trasparente

Materials:

- Body and bezel in die-cast aluminium, polyester painted
- Professional optic devices in thermoplastic material, mirror metallized
- Closing screen in clear polycarbonate





FALL / WINTER

NEW SEASON

RA 11 DIXIT LED



21 Bianco mat
Mat white

Codice Code	LED Lumen	Product Lumen	Watt	Colour T (K)	CRI	Fascio Beam
255-200BN	1700	1513	12			
	2350	2092	18	3000	85	55°
	2750	2448	21			
255-200AN	1800	1602	12			
	2450	2180	18	4000	85	55°
	2900	2581	21			

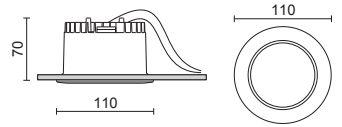

h 70mm ø 100mm 0,6kg

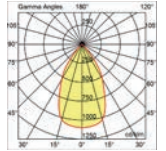

55°

Driver da ordinare separatamente Drivers should be ordered separately	Code	Watt	Output
	81-04010	12 W	Output 350mA - Regolabile sul taglio di fase - Dimmable on the mains
	81-04011	18 W	Output 500mA
	81-04022	21 W	Output 600mA
	81-04002	18 W	Output 500mA - Dimmerabile DALI - Dali dimmable

Accessori ottici intercambiabili
Replaceable optical accessories



Code	Description	12W	18W	21W
28-3140-51	Ottica professionale S Professional optic device S			
28-3142-51	Ottica professionale M Professional optic device M			
28-3138-51	Ottica professionale W Professional optic device W			
28-3141-31	Ottica professionale XW Professional optic device XW			
28-4019-30	Frangiluce alveolare Honeycomb			



RA 11 Q DIXIT LED



21 Bianco mat
Mat white

Codice Code	LED Lumen	Product Lumen	Watt	Colour T (K)	CRI	Fascio Beam
259-200BN	1700	1513	12	3000	85	55°
	2350	2092	18			
	3100	2759	26			
259-200AN	1800	1602	12	4000	85	55°
	2450	2100	18			
	3200	2848	26			

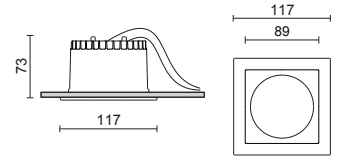

h 73mm ø 117mm 0,7kg

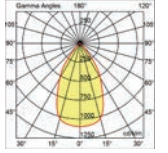

CE \neq 850° IP43 IK08 UGR<19 A++ A+ A

Driver da ordinare separatamente Drivers should be ordered separately	Code	Power	Output
	81-04010	12 W	Output 350mA - Regolabile sul taglio di fase - Dimmable on the mains
	81-04011	18 W	Output 500mA
	81-04012	26 W	Output 700mA
	81-04002	18 W	Output 500mA - Dimmerabile DALI - Dali dimmable

Accessori ottici intercambiabili
Replaceable optical accessories



Code	Accessory Name	12W	18W	26W
28-3140-51	Ottica professionale S Professional optic device S			
28-3142-51	Ottica professionale M Professional optic device M			
28-3138-51	Ottica professionale W Professional optic device W			
28-3141-31	Ottica professionale XW Professional optic device XW			
28-4019-30	Frangiluce alveolare Honeycomb			



RA 11 TL DIXIT LED



21 Bianco mat
Mat white

Codice Code	LED Lumen	Product Lumen	Watt	Colour T (K)	CRI	Fascio Beam
257-200BN	1700	1513	12	3000	85	55°
	2350	2092	18			
	2750	2448	21			
257-209BN	1500	1335	12	3000	90	55°
	2000	1780	18			
	2400	2136	21			

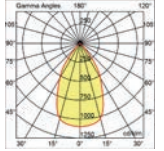
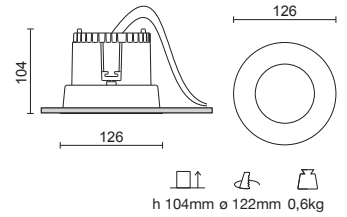

Driver da ordinare separatamente Drivers should be ordered separately				
		81-04010	12 W	Output 350mA - Regolabile sul taglio di fase - Dimmable on the mains
		81-04011	18 W	Output 500mA
		81-04022	21 W	Output 600mA
		81-04002	18 W	Output 500mA - Dimmerabile DALI - Dali dimmable

Accessori ottici intercambiabili
Replaceable optical accessories



28-3140-51	Ottica professionale S Professional optic device S	12W	18W	21W
28-3142-51	Ottica professionale M Professional optic device M	12W	18W	21W
28-3138-51	Ottica professionale W Professional optic device W	12W	18W	21W
28-3141-31	Ottica professionale XW Professional optic device XW	12W	18W	21W
28-4019-30	Frangiluce alveolare Honeycomb			

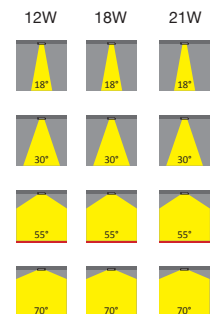

RA 11 SOFT DIXIT LED



21 Bianco mat
Mat white

Codice Code	LED Lumen	Product Lumen	Watt	Colour T (K)	CRI	Fascio Beam
258-200BN	1700	1513	12	3000	85	55°
	2350	2092	18			
	3100	2759	26			
258-209BN	1500	1335	12	3000	90	55°
	2000	1780	18			
	2600	2314	26			

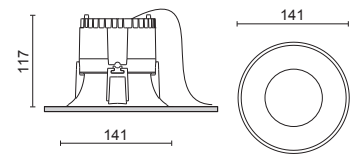

h 117mm ø 134mm 0,7kg

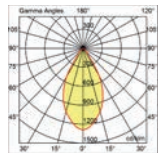

55°

Driver da ordinare separatamente
 Drivers should be ordered separately



81-04010	12 W	Output 350mA - Regolabile sul taglio di fase - Dimmable on the mains
81-04011	18 W	Output 500mA
81-04012	26 W	Output 700mA
81-04002	18 W	Output 500mA - Dimmerabile DALI - Dali dimmable

Accessori ottici intercambiabili
 Replaceable optical accessories



28-3140-51 Ottica professionale S
Professional optic device S

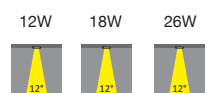

28-3142-51 Ottica professionale M
Professional optic device M

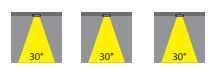

28-3138-51 Ottica professionale W
Professional optic device W



28-3141-31 Ottica professionale XW
Professional optic device XW



28-4019-30 Frangiluce alveolare
Honeycomb



RA 11 DIXIT LED

OSCILLANTE/ADJUSTABLE



21 Bianco mat
Mat white

Codice Code	LED Lumen	Product Lumen	Watt	Colour T (K)	CRI	Fascio Beam
256-200BN	1700	1513	12	3000	85	55°
	2350	2092	18			
	2750	2448	21			
256-200AN	1800	1602	12	4000	85	55°
	2450	2180	18			
	2900	2581	21			

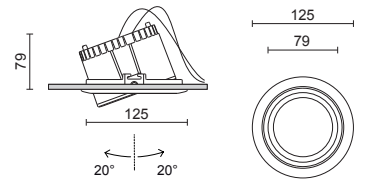

h 79mm ø 116mm 0,7kg

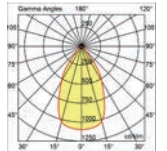

Driver da ordinare separatamente Drivers should be ordered separately				
	81-04010	12 W	Output 350mA - Regolabile sul taglio di fase - Dimmable on the mains	
	81-04011	18 W	Output 500mA	
	81-04022	21 W	Output 600mA	
	81-04002	18 W	Output 500mA - Dimmerabile DALI - Dali dimmable	

Accessori ottici intercambiabili Replaceable optical accessories



28-3140-51	Ottica professionale S Professional optic device S	12W	18W	21W
28-3142-51	Ottica professionale M Professional optic device M	12W	18W	21W
28-3138-51	Ottica professionale W Professional optic device W	12W	18W	21W
28-3141-31	Ottica professionale XW Professional optic device XW	12W	18W	21W
28-4019-30	Frangiluce alveolare Honeycomb	12W	18W	21W

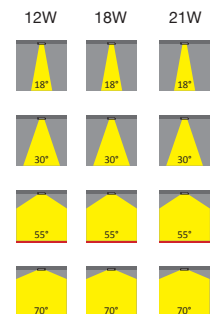



RA 14 DIXIT LED



21 Bianco mat
Mat white

52 Metal
Silver

Codice Code	LED Lumen	Product Lumen	Watt	Colour T (K)	CRI	Fascio Beam
-------------	-----------	---------------	------	--------------	-----	-------------

Corpo e anello in pressofusione di alluminio - Body and bezel in die-cast aluminium
 Schermo di chiusura in vetro temperato (4mm) - Tempered safety glass (4mm)
 Ottiche in termoplastico metallizzato - Optics in metallized thermoplastic material

243-250BN	3400	2924	26			
	4250	3655	33	3000	85	60°
	4900	4214	38			
243-250AN	3500	3100	26			
	4400	3748	33	4000	85	60°
	5000	4300	38			
243-259BN	2850	2451	26			
	3500	3010	33	3000	90	60°
	4000	3440	38			

Con emergenza 3h (su richiesta). **LED driver incluso.**
 With 3h emergency (on demand). **LED driver included.**

243-25E2	4900	4214	38	3000	85	60°
-----------------	------	------	----	------	----	-----

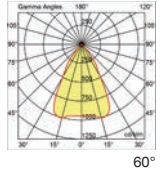
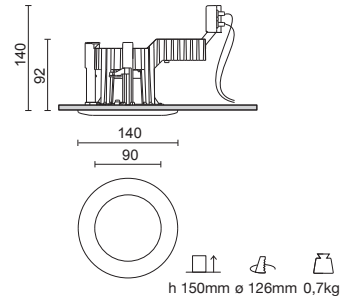

CE $\neq 850^\circ$ IP44 IK08

Driver da ordinare separatamente
 Drivers should be ordered separately



81-04012	26 W	Output 700mA
81-04013	33 W	Output 900mA
81-04013	38 W	Output 1050mA
81-04014	38 W	Output 1050mA - Dimmerabile DALI - Dali dimmable



28-3403

Cornice quadra con vetro trasparente 140x140mm
 Square frame with clear glass 140x140mm

21

52



98-13380-61

Vetro sabbiato
 Sand blasted glass



RA 16



21 Bianco mat
Mat white

52 Metal
Silver

Codice Code	LED Lumen	Product Lumen	Watt	Colour T (K)	CRI	Fascio Beam
-------------	-----------	---------------	------	--------------	-----	-------------

Corpo in pressofusione di alluminio - Body in die-cast aluminium
 Schermo di chiusura in policarbonato opale - Closing screen in opal polycarbonate

250-220BN	2400	1901	18	3000	85	110°
250-220AN	2450	1940	18	4000	85	110°

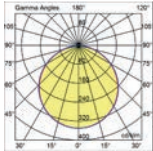
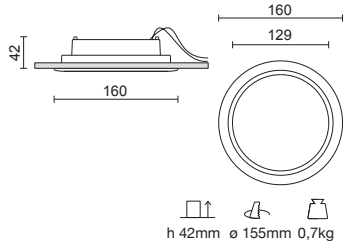

CE \neq 850° IP44 IK07

Driver da ordinare separatamente
 Driver should be ordered separately



81-04011 18 W Output 500mA

RA 17 DIXIT LED

OSCILLANTE/ADJUSTABLE

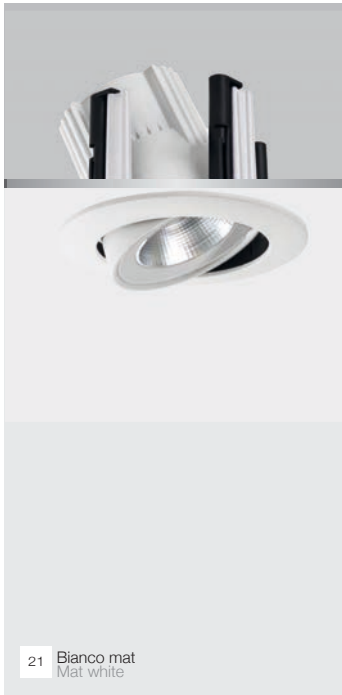

21 Bianco mat
Mat white

Codice Code	LED Lumen	Product Lumen	Watt	Colour T (K)	CRI	Fascio Beam
Corpo e anello in pressofusione di alluminio - Body and bezel in die-cast aluminium Schermo di chiusura in policarbonato trasparente - Closing screen in clear polycarbonate Ottiche in termoplastico metallizzato - Optics in metallized thermoplastic material						
248-230BN	4250	3770	33	3000	85	30°
248-230AN	4300	3814	33	4000	85	30°
248-240BN	5250	4510	36	3000	85	25°
248-240AN	5400	4639	36	4000	85	25°

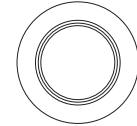
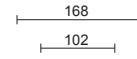
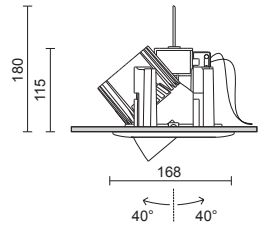

h 180mm ø 155mm 2,0kg

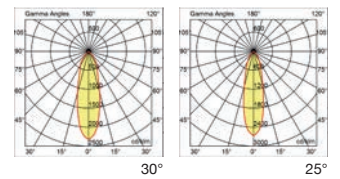

CE

Driver da ordinare separatamente
Drivers should be ordered separately



81-04015	33 W	Output 900mA
81-04013	36 W	Output 1050mA

Accessori ottici intercambiabili
Replaceable optical accessories



28-3140-51 Ottica professionale S
Professional optic device S

33W 36W



28-3142-51 Ottica professionale M
Professional optic device M



28-3138-51 Ottica professionale W
Professional optic device W



28-3141-31 Ottica professionale XW
Professional optic device XW



RA 18 DIXIT LED

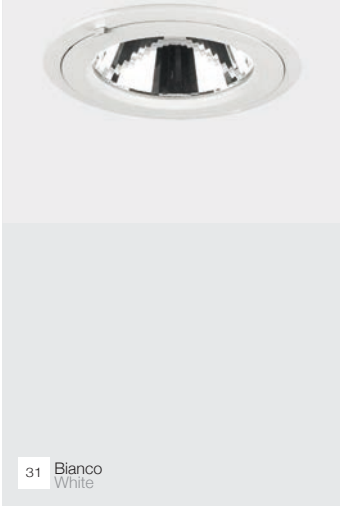

Codice Code	LED Lumen	Product Lumen	Watt	Colour T (K)	CRI	Fascio Beam
-------------	-----------	---------------	------	--------------	-----	-------------

Corpo e anello in pressofusione di alluminio - Body and bezel in die-cast aluminium
 Ottiche in termoplastico metallizzato - Optics in metallized thermoplastic material

LED Fortimo DLM. **LED driver incluso.**
 DLM Fortimo LED. **LED driver included.**

209-510	2000	1817	22	3000	80	54°
209-531	3000	2670	34	3000	80	52°

Con driver DALI (su richiesta)
 With DALI driver (on demand)

209-541	3000	2670	34	3000	80	52°
----------------	------	------	----	------	----	-----

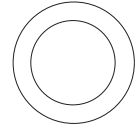
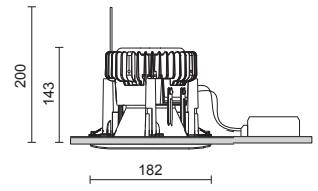

h 200mm ø 172mm 1,4kg

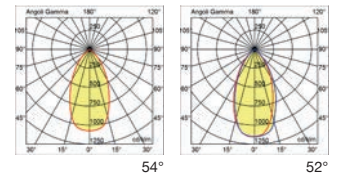

31 Bianco
 White

CE RoHS Energy Star 850° IP43 IK07 A++ A+ A

RA 20 DIXIT LED

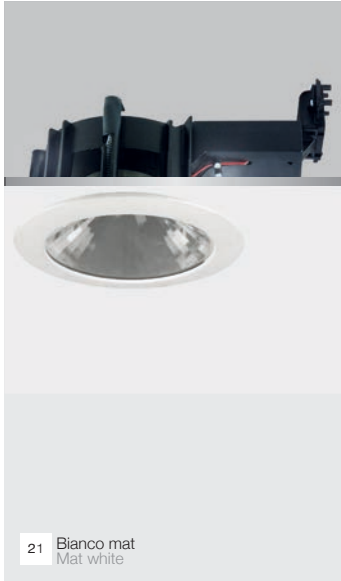

Codice Code	LED Lumen	Product Lumen	Watt	Colour T (K)	CRI	Fascio Beam
-------------	-----------	---------------	------	--------------	-----	-------------

Corpo e anello in pressofusione di alluminio - Body and bezel in die-cast aluminium
 Schermo di chiusura in vetro temprato (4mm) - Tempered safety glass (4mm)
 Ottiche in termoplastico metallizzato - Optics in metallized thermoplastic material

244-242BN	6400	5485	51	3000	85	100°
244-242AN	6600	5656	51	4000	85	100°

Con emergenza 3h (su richiesta). **LED driver incluso.**
 With 3h emergency (on demand). **LED driver included.**

244-24E2	6400	5485	51	3000	85	100°
-----------------	------	------	----	------	----	------

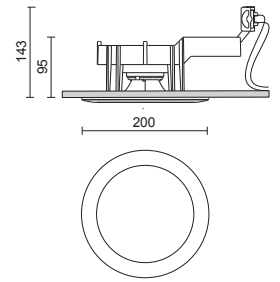

h 143mm ø 185mm 1,8kg

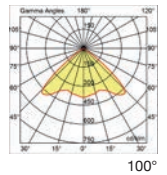

$\neq 850^\circ$ IP44 IK07 **A+ A+ A**

Driver da ordinare separatamente
 Drivers should be ordered separately

	81-04004	51 W	Output 1400mA
	81-04016	51 W	Output 1400mA - Dimmerabile DALI - Dali dimmable

RA 20 WW DIXIT LED WALLWASHER



Corpo e anello in pressofusione di alluminio - Body and bezel in die-cast aluminium
 Schermo di chiusura in vetro temprato (4mm) - Tempered safety glass (4mm)
 Ottiche in termoplastico metallizzato - Optics in metallized thermoplastic material

244-242WBN	6400	5485	51	3000	85	60°
-------------------	------	------	----	------	----	-----

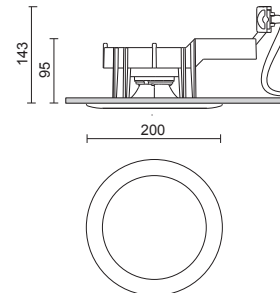

h 143mm ø 185mm 1,4kg

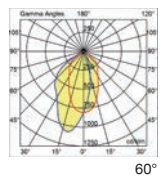

$\neq 850^\circ$ IP44 IK07 **A+ A+ A**

Driver da ordinare separatamente
 Drivers should be ordered separately

	81-04004	51 W	Output 1400mA
	81-04016	51 W	Output 1400mA - Dimmerabile DALI - Dali dimmable

RA 23 S DIXIT LED



21 Bianco mat
Mat white

Codice Code	LED Lumen	Product Lumen	Watt	Colour T (K)	CRI	Fascio Beam
Corpo e anello in pressofusione di alluminio - Body and bezel in die-cast aluminium Schermo di chiusura in vetro temprato (4mm) - Tempered safety glass (4mm) Ottiche in termoplastico metallizzato - Optics in metallized thermoplastic material						
249-210BN	2550	2248	18	3000	85	100°
249-210AN	2600	2292	18	4000	85	100°
249-200BN	4900	4322	37	3000	85	100°
	5500	4851	43			
249-200AN	5100	4489	37	4000	85	100°
	5750	5072	43			

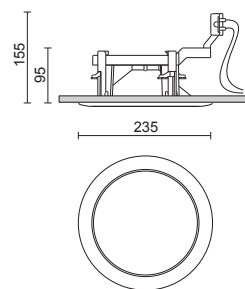

h 155mm ø 220mm 1,5kg

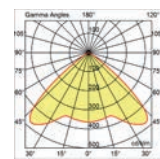

100°



Driver da ordinare separatamente Drivers should be ordered separately		Power (W)	Output (mA)
	81-04011	18 W	Output 500mA
	81-04013	37 W	Output 1050mA
	81-04017	43 W	Output 1200mA

RA 23 SP DIXIT LED

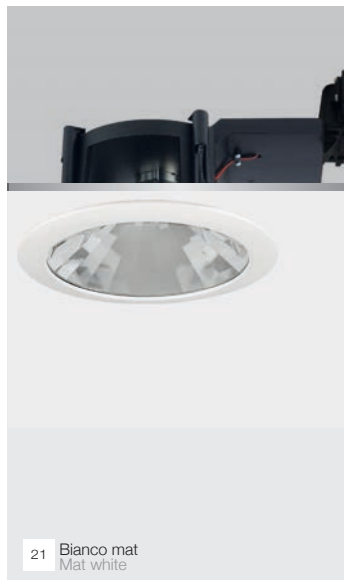

21 Bianco mat
Mat white

Codice Code	LED Lumen	Product Lumen	Watt	Colour T (K)	CRI	Fascio Beam
Corpo e anello in pressofusione di alluminio - Body and bezel in die-cast aluminium Schermo di chiusura in vetro temprato (4mm) - Tempered safety glass (4mm) Ottiche in termoplastico metallizzato - Optics in metallized thermoplastic material						
249-240BN	6800	5827	51	3000	85	100°
249-240AN	7000	5998	51	4000	85	100°
249-250BN	9900	9549	75	3000	85	100°
249-250AN	10200	9838	75	3000	85	100°

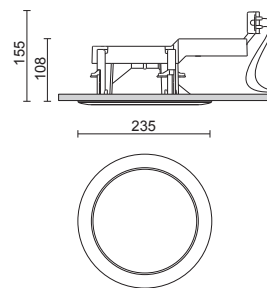

h 155mm ø 220mm 3,6kg



Driver da ordinare separatamente Drivers should be ordered separately		Power (W)	Output (mA)
	81-04004	51 W	Output 1400mA
	81-04018	75 W	Output 1400mA



DJ



Codice Code	Colore Colour	LED Lumen	Product Lumen	Watt	Colour T (K)	CRI	Fascio Beam
Corpo in policarbonato traslucido stampato a iniezione - Injection-molded translucent polycarbonate body							
2400-10-31	Bianco/White	100	-	1	3000	80	24°
2400-10-64	Blu/Blue	-	-	1	-	-	24°

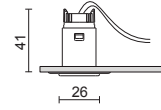

ø 24mm 0,02kg

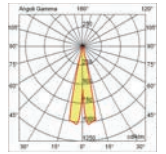

24°



DJ CON ANELLO

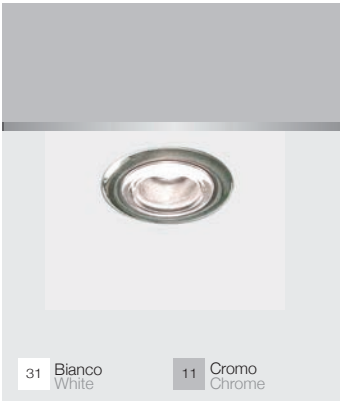

Corpo in policarbonato traslucido stampato a iniezione - Injection-molded translucent polycarbonate body Con anello in acciaio - With steel ring							
2400-31	Bianco/White	100	-	1	3000	80	24°

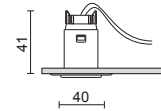

ø 24mm 0,02kg

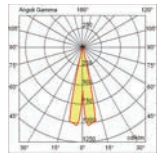

24°



31 Bianco White

11 Cromo Chrome

Driver da ordinare separatamente
Driver should be ordered separately



81-04020

15 W

Corrente costante - Output 350mA - Max 15 pz ogni 30mt
Constant current - Output 350mA - Max 15 pc max distance 30mt



RA 7



21 Bianco mat
Mat white

Codice Code	LED Lumen	Product Lumen	Watt	Colour T (K)	CRI	Fascio Beam
251-200	540	378	4,6	3000	85	120°

Corpo in pressofusione di alluminio - Body in die-cast aluminium
 Schermo di chiusura in policarbonato opale - Closing screen in opal polycarbonate

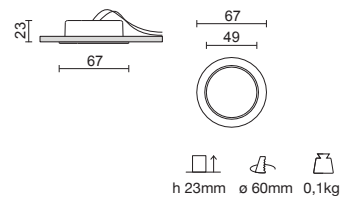

h 23mm ø 60mm 0,1kg

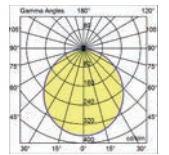

120°

CE \neq 850° IP43 IK07 A+ A+ A



Driver da ordinare separatamente
 Driver should be ordered separately



81-04019

20 W

Corrente costante - Output 500mA - Max 4 pz ogni 30mt
 Constant current - Output 500mA - Max 4 pc max distance 30mt

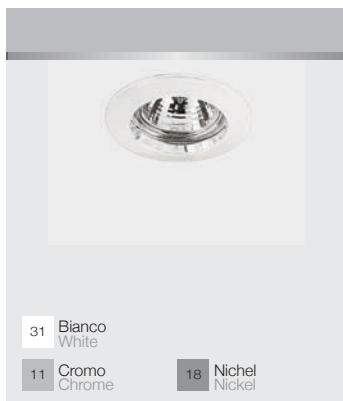

Codice Code	Lampada Lamp	Attacco Base
Corpo in alluminio - Aluminium body		
2055-10	HR 50W/MR16 4W LED	GU5.3

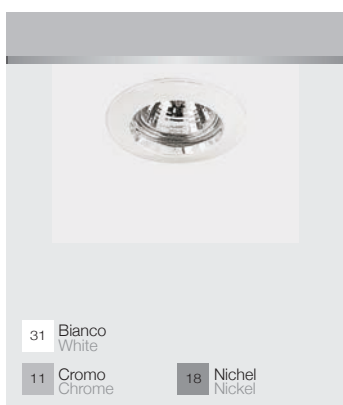
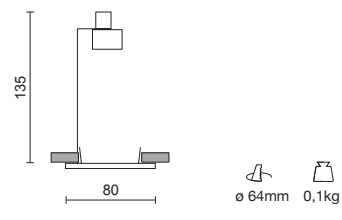

Corpo in alluminio - Aluminium body		
2056-10	IPAR16 50W/LED	GU10

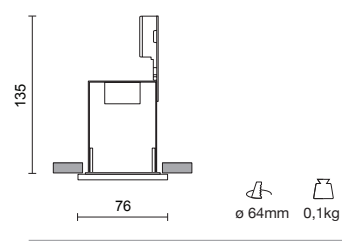

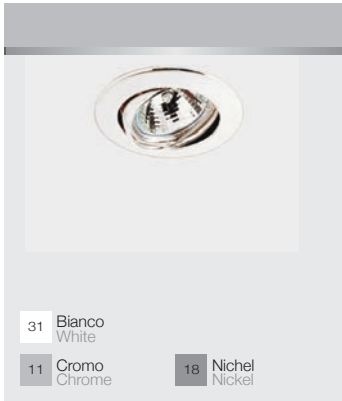

Codice Code	Lampada Lamp	Attacco Base
Corpo in alluminio - Aluminium body		
2057-10	HR 50W/MR16 4W LED	GU5.3

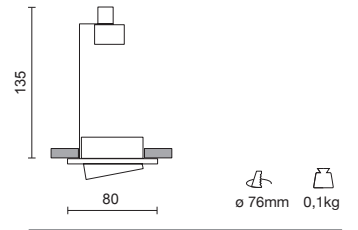

Corpo in alluminio - Aluminium body		
2058-10	IPAR16 50W/LED	GU10

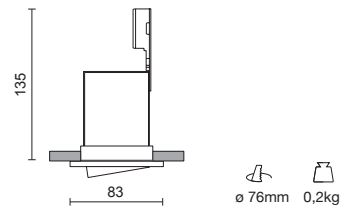



Kardan-IN
p.156



Kardan-IN
p.156



Kardan-TL
p.157



Kardan-TL
p.157



Minikyclos-IN
p.159



Minikyclos-IN
p.159



Kyclos-TL
p.161



Kyclos-TL
p.161

Proiettori da incasso

RECESSED SPOTLIGHTS

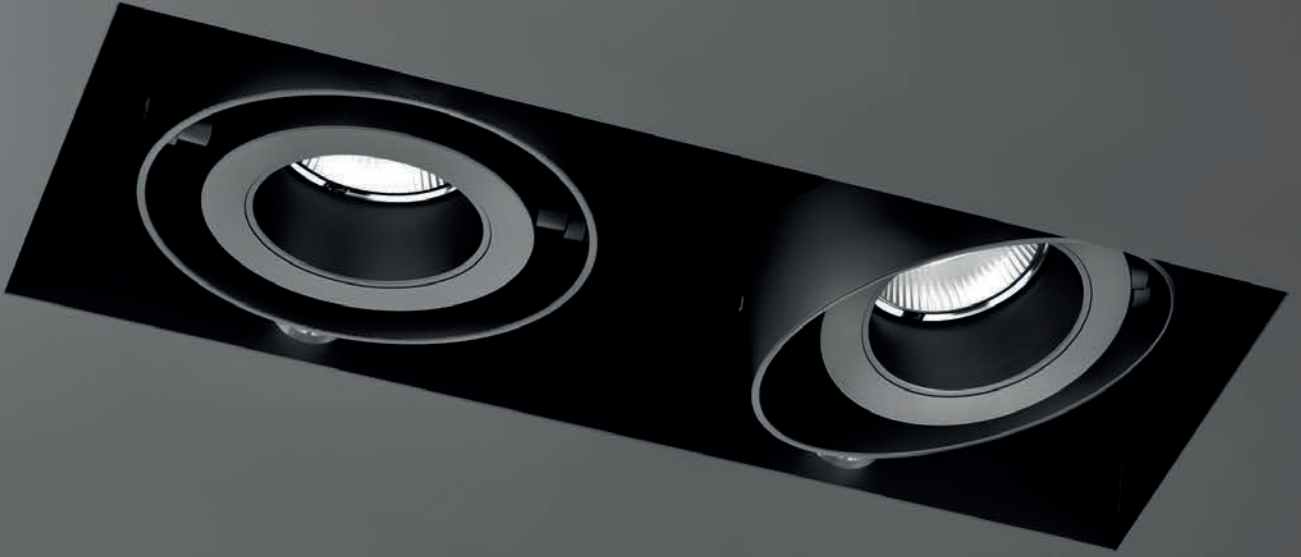

Kardan-IN/TL

Studio Tecnico Ivela

Sistema di illuminazione multidirezionale per LED COB di ultima generazione, caratterizzato da una o due fonti luminose orientabili e indipendenti fra loro, con oppure senza cornice di finitura. Questa flessibilità dell'orientamento consente di modulare la luce, in modo da rendere omogeneo il contesto generale e nello stesso tempo esaltarne i dettagli.

Kardan-IN è ideale per ambienti espositivi e ovunque siano richieste luci d'accento, come vetrine, musei, gallerie d'arte.

Facilmente integrabile in ogni tipologia di arredo grazie alle sue linee essenziali e discrete.

LED driver da ordinare separatamente, la potenza dell'apparecchio varia a seconda del driver scelto.

A multi-directional lighting system for the last generation of COB LEDs, featuring one or two adjustable and independent light sources, with or without decorative frame. This flexibility in orientation allows to modulate light, granting an effect of uniform lighting whilst enhancing details at the same time.

Kardan-IN is ideal for display areas and wherever accent lighting is required, such as shop windows, museums and art galleries. Its clean and essential design makes it suitable for any type of interior.

LED drivers should be ordered separately, the wattage of the fittings changes, depending on the selected driver.







Materiali

- Corpo illuminante in pressofusione di alluminio verniciato poliестere.
- Cilindro antiabbagliamento interno in termoplastico nero
- Ottiche professionali intercambiabili in termoplastico metallizzato a specchio.
- Cornice in acciaio verniciato poliестere.
- Cassa interna in acciaio verniciato nero.

Materials

- Lighting body in die-cast aluminium polyester painted
- Inner snoot in black thermoplastic material
- Replaceable professional optic devices in thermoplastic mirror-metallized
- Steel frame, polyester painted
- Inner body in black painted steel



KARDAN-IN

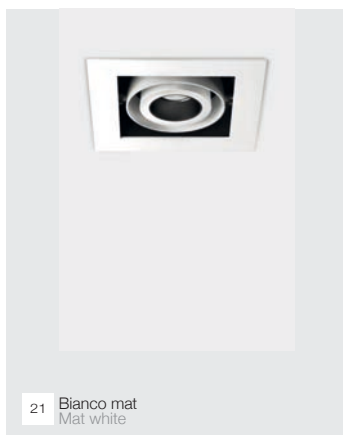

21 Bianco mat
Mat white

Codice Code	LED Lumen	Product Lumen	Watt	Colour T (K)	CRI	Fascio Beam
Con cornice With frame						
508-211BN	1x1700	-	1x12	3000	85	30°
	1x2400	-	1x18			
508-211AN	1x1800	-	1x12	4000	85	30°
	1x2500	-	1x18			

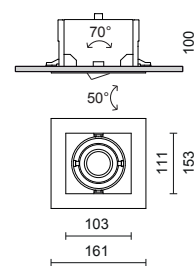

h 105mm 135x130mm 1,0kg

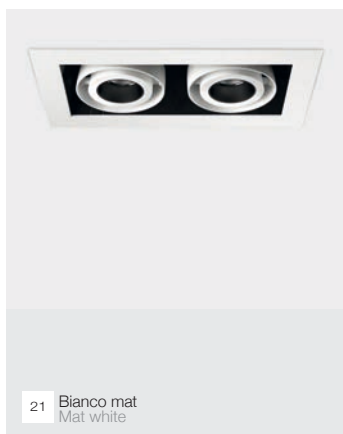

21 Bianco mat
Mat white

Codice Code	LED Lumen	Product Lumen	Watt	Colour T (K)	CRI	Fascio Beam
Con cornice With frame						
508-221BN	2x1700	-	2x12	3000	85	30°
	2x2400	-	2x18			
508-221AN	2x1800	-	2x12	4000	85	30°
	2x2500	-	2x18			

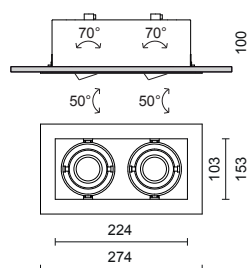

h 105mm 135x245mm 2,0kg



Driver da ordinare separatamente Drivers should be ordered separately	Code	Watt	Output	Notes
	81-04010	1x12 W	Output 350mA	Regolabile sul taglio di fase - Dimmable on the mains
	81-04011	1x18 W	Output 500mA	
	81-04012	2x12 W	Output 2x350mA	
	81-04021	2x18 W	Output 2x500mA	

Accessori ottici intercambiabili
Replaceable optical accessories



28-3901-51

Ottica professionale S
Professional optical device S

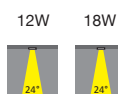

28-3902-51

Ottica professionale M
Professional optical device M

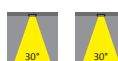

28-3903-51

Ottica professionale W
Professional optical device W



28-3905-47

Schermo di chiusura in termoplastico trasparente
Closing screen in clear thermoplastic material

* Accessorio da utilizzare esclusivamente insieme a cod. 28-3905-47



28-4022-30*

Frangiluce alveolare
Honeycomb

* Accessory to be used only with code 28-3905-47



KARDAN-TL

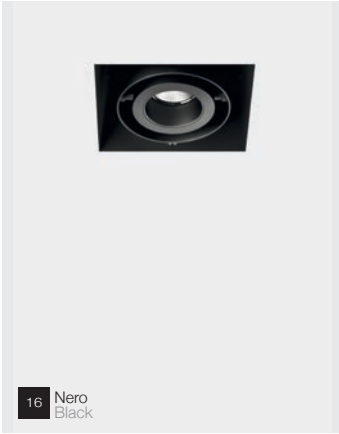

Codice Code	LED Lumen	Product Lumen	Watt	Colour T (K)	CRI	Fascio Beam
Senza cornice Trimless						
509-211BN	1x1700	-	1x12	3000	85	30°
	1x2400	-	1x18			
509-211AN	1x1800	-	1x12	4000	85	30°
	1x2500	-	1x18			

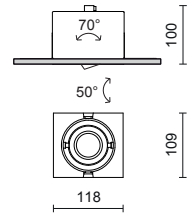

h 170mm 115x124mm 1,0kg

CE $\approx 850^\circ$ IP20 **A+ A+ A**

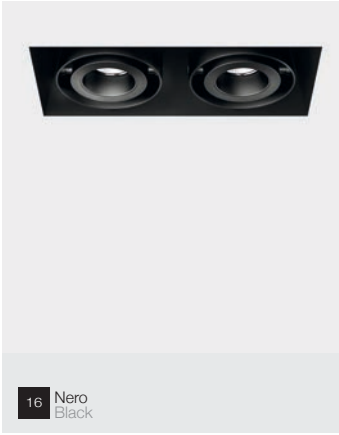

Senza cornice Trimless						
509-221BN	2x1700	-	2x12	3000	85	30°
	2x2400	-	2x18			
509-221AN	2x1800	-	2x12	4000	85	30°
	2x2500	-	2x18			

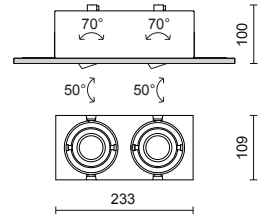

h 170mm 115x238mm 2,0kg

CE $\approx 850^\circ$ IP20 **A+ A+ A**

Driver da ordinare separatamente
Drivers should be ordered separately



81-04010	1x12 W	Output 350mA - Regolabile sul taglio di fase - Dimmable on the mains
81-04011	1x18 W	Output 500mA
81-04012	2x12 W	Output 2x350mA
81-04021	2x18 W	Output 2x500mA

Accessori ottici intercambiabili
Replaceable optical accessories



28-3901-51 Ottica professionale S
Professional optic device S

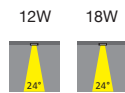

28-3902-51 Ottica professionale M
Professional optic device M

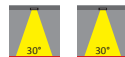

28-3903-51 Ottica professionale W
Professional optic device W



28-3905-47 Schermo di chiusura in termoplastico trasparente
Closing screen in clear thermoplastic material

* Accessorio da utilizzare esclusivamente insieme a cod. 28-3905-47



28-4022-30* Frangiluce alveolare
Honeycomb

* Accessory to be used only with code 28-3905-47





Minikyclos-IN

design: **Enrico Davide Bona e Elisa Nobile**

Minikyclos-IN è un proiettore orientabile da incasso di piccole dimensioni, progettato per l'impiego di LED COB ad alta efficienza di ultima generazione. Disponibile in versione a una o due luci, **Minikyclos-IN** si caratterizza per la pulizia delle linee e per l'equilibrio delle forme, diventando la soluzione ideale per l'illuminazione in vetrine di negozi, sale espositive, showroom.

La sua particolare struttura a filo soffitto ne riduce l'impatto visivo e dona personalità negli allestimenti. Il gruppo ottico è ruotabile fino a 355° con un'inclinazione di +/- 45° per un'ampia flessibilità di utilizzo. Può essere accessorizzato con ottiche professionali per fasci luminosi diversi, facilmente sostituibili anche quando l'apparecchio è già installato. LED driver da ordinare separatamente, la potenza dell'apparecchio varia a seconda del driver scelto. **Minikyclos** è anche proiettore per binari elettrificati (vedi pag. 58-59).

Materiali:

- Corpo illuminante in pressofusione di alluminio verniciato poliestere
- Frontale di chiusura in policarbonato trasparente retroverniciato per un effetto brillante
- Ottiche professionali in termoplastico metallizzato a specchio
- Cornice in acciaio verniciato poliestere
- Cassa interna in acciaio verniciato nero

Minikyclos-IN is a recessed spotlight, tiltable and very compact in size, specifically designed to be equipped with high-efficiency COB-LEDs of last generation. Available in single or twin-light version,

Minikyclos-IN excels in design by virtue of its clean lines and well balanced shapes, and it is the right solution in applications such as shop windows, exhibitions, showrooms. Thanks to its installation flush in ceilings, it shows a reduced visual impact, providing an illumination full of personality.

The head can pivot through +/- 45° and rotate through up to 355° to point the light beam with the highest accuracy and flexibility.

A number of professional optics for different beam angles is available, easy to replace without tools, also in case of already installed luminaires.

LED drivers should be ordered separately the wattage of the fittings changes, depending on the selected driver.

Minikyclos is also a spotlight for electrified tracks (see page 58-59).

Materials:

- Body in die-cast aluminium polyester painted
- Front closing screen in clear polycarbonate, painted on the rear for a brighter effect
- Professional optic devices in thermoplastic material, mirror-metallized
- Frame in steel, polyester painted
- Recessed body in steel, painted in black

Modello di design depositato / Registered design model



MINIKYCLOS-IN

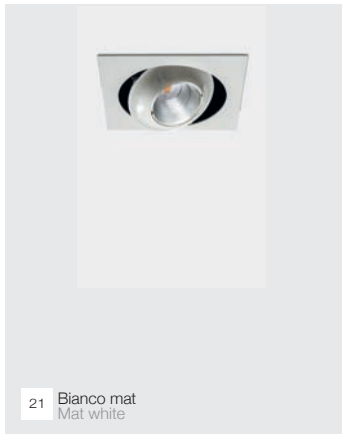

21 Bianco mat
Mat white

Codice Code	LED Lumen	Product Lumen	Watt	Colour T (K)	CRI	Fascio Beam
Con cornice With frame						
529-311BN	1x2500	1x2215	1x18	3000	85	25°
	1x3400	1x3013	1x24			
529-311AN	1x2600	1x2304	1x18	4000	85	25°
	1x3500	1x3101	1x24			

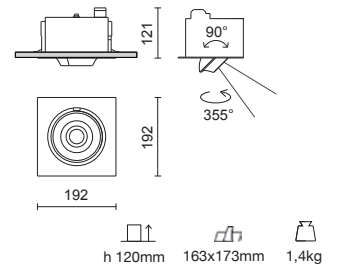

h 120mm 163x173mm 1,4kg

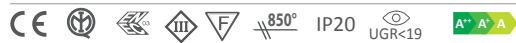
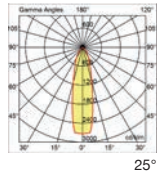

21 Bianco mat
Mat white

Codice Code	LED Lumen	Product Lumen	Watt	Colour T (K)	CRI	Fascio Beam
Con cornice With frame						
529-321BN	2x2500	2x2215	2x18	3000	85	25°
	2x3400	2x3013	2x24			
529-321AN	2x2600	2x2304	2x18	4000	85	25°
	2x3500	2x3101	2x24			

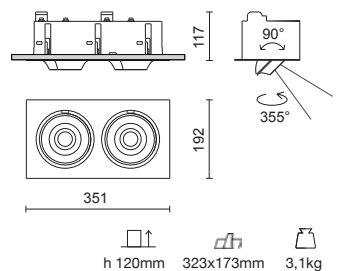

h 120mm 323x173mm 3,1kg

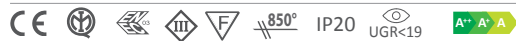
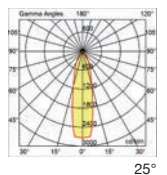

Driver da ordinare separatamente Drivers should be ordered separately	Part Number	Watt	Output
	81-04011	1x18 W	Output 500mA
	81-04013	2x18 W	Output 2x500mA
	81-04012	1x24 W	Output 700mA
	81-04004	2x24 W	Output 2x700mA

Accessori ottici intercambiabili
Replaceable optical accessories



28-3140-51 Ottica professionale S
Professional optic device S

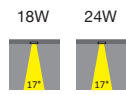

28-3142-51 Ottica professionale M
Professional optic device M

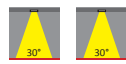

28-3138-51 Ottica professionale W
Professional optic device W



28-3141-31 Ottica professionale XW
Professional optic device XW



28-3957-30 Cilindro antiabbagliamento
Snoot



28-3959-30* Frangiluce alveolare
Honeycomb



28-3958-58* Vetro temprato trasparente
Clear tempered glass



28-3958-32* Vetro temprato con filtro food rosato
Pink tempered glass for food application

* Accessori da utilizzare esclusivamente insieme a snoot cod. 28-3957-30

* Accessories to be used only with snoot code 28-3957-30





Kyclos-TL

design: **Enrico Davide Bona e Elisa Nobile**

Kyclos-TL è un proiettore orientabile da incasso ideale per la progettazione illuminotecnica di negozi, sale espositive e showroom. Impiega sorgenti luminose LED COB di ultima generazione, assicurando eccellenti prestazioni con il massimo risparmio energetico. E' disponibile in versione a una o due luci, senza cornice: sulla controcassa sono posizionate delle squadrette d'acciaio regolabili per permettere un'installazione trimless in controsoffitti o pannellature. **Kyclos-TL** è la soluzione per un'illuminazione efficiente dall'elevata resa cromatica, unita ad un ottimale comfort visivo.

I corpi illuminanti fuoriescono dal vano incassato con un orientamento di 90° e una rotazione fino a 355°.

La versatilità d'orientamento del fascio luminoso permette un'illuminazione d'accento estremamente dinamica, ideale per far risaltare dettagli espositivi e superfici.

Può essere accessorizzato con ottiche professionali per fasci luminosi diversi, facilmente sostituibili anche quando l'apparecchio è già installato.

LED driver da ordinare separatamente, la potenza dell'apparecchio varia a seconda del driver scelto.

Kyclos-TL è parte della famiglia Kyclos, che comprende anche proiettori per binari elettrificati (vedi pag. 64-65).

Materiali:

- Corpo illuminante in pressofusione di alluminio verniciato poliester
- Frontale di chiusura in policarbonato trasparente retroverniciato per ottenere un innovativo effetto brillante
- Ottiche professionali in termoplastico metallizzato a specchio
- Cassa interna in acciaio verniciato nero

Kyclos-TL is a recessed tiltable spotlight ideal for shops, exhibition areas and showrooms. It is equipped with COB LED sources of the last generation, achieving excellent results both in terms of lighting performance and of energy saving.

It is available in single or twin-light version, without decorative frame: the fitting is provided with adjustable steel accessories for a trimless installation in false ceilings and panels.

Kyclos-TL is an efficient lighting solution, ensuring high colour rendering and excellent visual comfort.

The heads stick out from the recessed body, and can pivot through 90° and rotate through 355° to point the beam with the highest accuracy, for a flexible and dynamic accent lighting of objects and spaces.

Replaceable professional optics for different beam angles are available, also when the fitting is already installed.

LED drivers should be ordered separately, the wattage of the fittings changes, depending on the selected driver.

Kyclos-TL is part of the Kyclos range, including spotlights for electrified tracks (see page 64-65).

Materials:

- Body in die-cast aluminium polyester painted
- Front closing screen in clear polycarbonate, painted on the rear for a brighter effect
- Professional optic devices in thermoplastic material, mirror-metallized
- Recessed body in steel, painted in black

Modello di design depositato / Registered design model



KYCLOS-TL

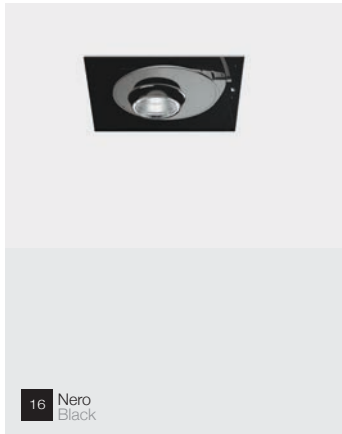

16 Nero Black

Codice Code	LED Lumen	Product Lumen	Watt	Colour T (K)	CRI	Fascio Beam
Senza cornice Trimless						
528-511BN	1x5300	1x4521	1x36	3000	85	25°
	1x6800	1x5800	1x51			
528-511AN	1x5500	1x4692	1x36	4000	85	25°
	1x7000	1x5971	1x51			

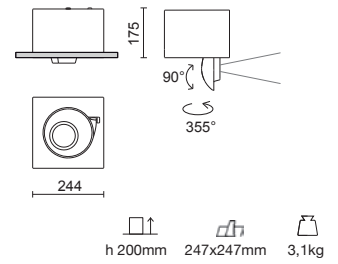

h 200mm 247x247mm 3,1kg

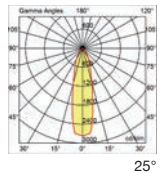

CE RoHS ENEC III F 850° IP20 A+ A+ A

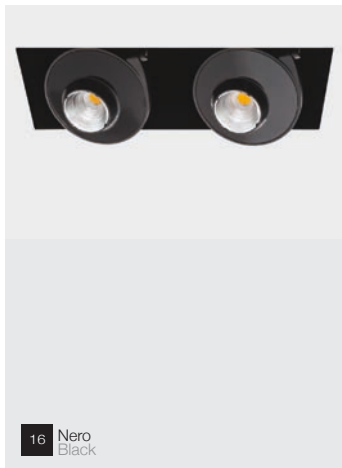

16 Nero Black

Codice Code	LED Lumen	Product Lumen	Watt	Colour T (K)	CRI	Fascio Beam
Senza cornice Trimless						
528-521BN	2x5300	2x4521	2x36	3000	85	25°
	2x6800	2x5800	2x51			
528-521AN	2x5500	2x4692	2x36	4000	85	25°
	2x7000	2x5971	2x51			

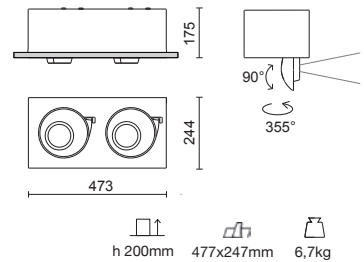

h 200mm 477x247mm 6,7kg

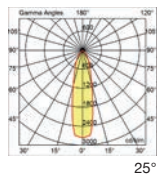

CE RoHS ENEC III F 850° IP20 A+ A+ A

Driver da ordinare separatamente
Drivers should be ordered separately



81-04013	1x36 W	Output 1050mA
81-04013	2x36 W	Output 2x1050mA (E' necessario ordinare 2 driver - 2 LED drivers should be ordered)
81-04004	1x51 W	Output 1400mA
81-04004	2x51 W	Output 2x1400mA (E' necessario ordinare 2 driver - 2 LED drivers should be ordered)

Accessori ottici intercambiabili
Replaceable optic accessories



28-3140-51 Ottica professionale S Professional optic device S

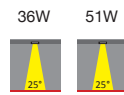

28-3142-51 Ottica professionale M Professional optic device M

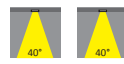

28-3138-51 Ottica professionale W Professional optic device W

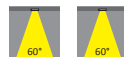

28-3141-31 Ottica professionale XW Professional optic device XW



28-3957-30 Cilindro antiabbagliamento Snoot



28-3959-30* Frangiluce alveolare Honeycomb



28-3958-58* Vetro temprato trasparente Clear tempered glass

* Accessori da utilizzare esclusivamente insieme a snoot cod. 28-3957-30



28-3958-32* Vetro temprato con filtro food rosato Pink tempered glass for food application

* Accessories to be used only with snoot code 28-3957-30









Miniperfetto-S
p.169



Iconica
p.173



Flood
p.175



Sofi 301
p.177



Aplomb 350 Led
p.179



Boma Led-S
p.181



Zeppel 400
p.183



Sospensioni

SUSPENSIONS



Miniperfetto-S

Studio Tecnico Ivela

Miniperfetto-S è la sofisticata versione a sospensione del proiettore Miniperfetto. Insieme alle altre versioni della gamma, offre soluzioni illuminotecniche personalizzate e flessibili, ideali per ogni esigenza progettuale.

Le ottiche arretrate e lo snoot di serie rendono

Miniperfetto-S ideale per le sue proprietà antiabbaglianti.

Miniperfetto-S, con LED COB ad alta efficienza, può essere personalizzato con una serie di accessori per un miglior comfort visivo.

Il suo design, dalle linee compatte e testa cilindrica estremamente elegante, si inserisce facilmente in numerosi contesti, dal retail, all'hospitality, al residenziale.

Materiali:

- Corpo e rosone in pressofusione di alluminio verniciato poliester
- Basetta di fissaggio al soffitto in materiale termoplastico
- Ottiche professionali in termoplastico metallizzato a specchio
- Cilindro antiabbagliante interno in termoplastico nero
- Cavo di sospensione in tessuto nero, lunghezza 2mt

Miniperfetto-S is the sophisticated suspended version of the Miniperfetto spotlight. Together with the other versions of the range it offers customized and flexible lighting solutions, ideal for any design requirements.

The deeply-recessed optics and the standard snoot make

Miniperfetto-S ideal for its anti-glare properties.

Miniperfetto-S, with high efficiency COB LED, can be customized with a range of accessories for a better visual comfort. Its design, featuring compact lines and extremely elegant cylindrical head, fits easily into a variety of contexts, from retail to hospitality, to the residential.

Materials:

- Body and canopy in die-cast aluminum polyester painted
- Ceiling fixing base in thermoplastic material
- Professional optics in mirror metallized thermoplastic material
- Interior anti-glare cylinder in black thermoplastic material
- Suspension cable in black fabric, 2 mt length

Modello di design depositato / Registered design model





MINIPERFETTO-S



21 Bianco mat
Mat white

16 Nero
Black

52 Metal su richiesta
Silver on demand

Codice Code	LED Lumen	Product Lumen	Watt	Colour T (K)	CRI	Fascio Beam
748-119	1450	1050	12	3000	90	30°
748-111A	1750	1258	12	4000	85	30°

Versioni per binari elettrificati, con base e con rosone semi-incassato vedi pag.44, 45
Versions for electrified tracks, with base and with semi-recessed canopy see page 44, 45

220/240V - 50/60Hz

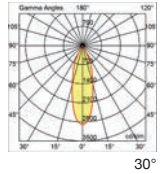
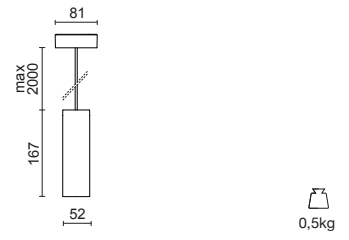
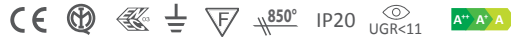

Accessori ottici intercambiabili Replaceable optical accessories



28-3901-51

Ottica professionale S
Professional optic device S

12W



28-3902-51

Ottica professionale M
Professional optic device M



28-3903-51

Ottica professionale W
Professional optic device W



28-3979-100

Cilindro antiabbagliamento dorato
Golden snoot



28-3905-47

Schermo di chiusura in termoplastico trasparente
Closing screen in clear thermoplastic material

* Accessorio da utilizzare esclusivamente insieme a cod. 28-3905-47



28-4022-30*

Frangiluce alveolare
Honeycomb

* Accessory to be used only with code 28-3905-47







Iconica

design: **Enrico Davide Bona e Elisa Nobile**

Iconica è un'innovativa lampada a sospensione dalle dimensioni miniaturizzate e dalle elevate prestazioni illuminotecniche, grazie all'impiego della tecnologia LED COB a tensione di rete.

È ideale sia come singolo punto luce sia in composizione, per il retail, l'hospitality e nel residenziale.

Iconica è caratterizzata da un design puro ed evocativo: la forma conica essenziale ed elegante del corpo è segnata da quattro scanalature in corrispondenza dell'innesto del cavo elettrico. Un segno che diventa così elemento di giunzione tra il volume del cono e il cavo in tessuto nero. Il rosone a soffitto è stato progettato come un cono rovesciato, in simmetria con l'apparecchio.

Iconica è regolabile sulla fase (230V).

Questa piccola sospensione in pressofusione di alluminio è proposta in 4 finiture cromatiche che ne esaltano la personalità: dal bianco goffrato che dona morbidezza ai volumi, all'eleganza del nero, all'effetto metallizzato della verniciatura cromata, fino all'inedita modernità del rame spazzolato.

Iconica is an innovative and miniaturized suspension lamp, with a high lighting performance, thanks to the supply voltage LED COB technology. It is ideal both as single fitting and in composition with others, for retail, hospitality and for residential applications. **Iconica** features a pure and evocative design: the conical shape of the body, essential and elegant, is lined by four grooves, marking the connection between the volume of the cone and the cable in black fabric. The ceiling canopy has designed as an inverted cone, symmetrically with the fitting.

Iconica is dimmable on the mains (230V).

This little suspension in die-cast aluminium is available in four colours that highlight its personality: mat white, giving smoothness to volumes, the elegance of black; the metallized effect of a chromed finishing, and the innovative brushed copper.





Materiali:

- Corpo e rosone in pressofusione di alluminio verniciato poliестere
- Basetta di fissaggio al soffitto in materiale termoplastico
- Ottiche professionali in termoplastico metallizzato a specchio
- Cavo di sospensione in tessuto nero, lunghezza 2mt

Materials:

- Body and canopy in die-cast aluminium, polyester painted
- Ceiling fixing base in thermoplastic material
- Professional optics in mirror metallized thermoplastic material
- Suspension cable in black fabric, 2mt length

ICONICA

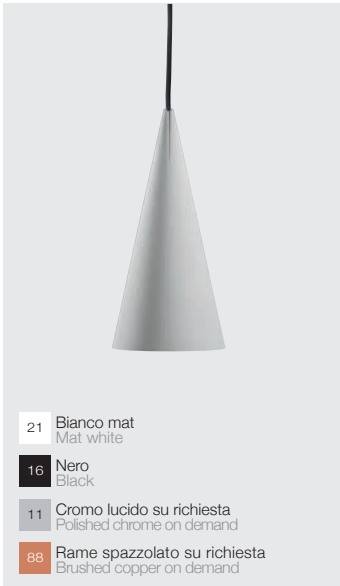

- 21** Bianco mat
Mat white
- 16** Nero
Black
- 11** Cromo lucido su richiesta
Polished chrome on demand
- 88** Rame spazzolato su richiesta
Brushed copper on demand

Codice Code	LED Lumen	Product Lumen	Watt	Colour T (K)	CRI	Fascio Beam
3920-01	1000	890	9,5	3000	80	60°
3921-01	2000	1780	19	3000	80	60°

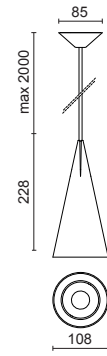

1,3kg

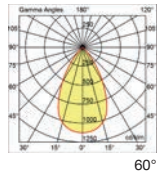

Con LED a tensione di rete regolabile sulla fase
With supply voltage LED dimmable on the mains

220/240V - 50/60Hz

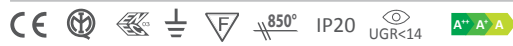

Accessori ottici intercambiabili Replaceable optical accessories



28-3140-51

Ottica professionale S
Professional optic device S

9,5W

19W



28-3142-51

Ottica professionale M
Professional optic device M

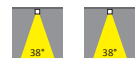

28-3138-51

Ottica professionale W
Professional optic device W

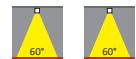

28-3141-31

Ottica professionale XW
Professional optic device XW



28-3957-30

Cilindro antiabbagliamento
Snoot



28-3959-30*

Frangiluce alveolare
Honeycomb



28-3958-58*

Vetro temperato trasparente
Clear tempered glass

* Accessori da utilizzare esclusivamente insieme a snoot cod. 28-3957-30



28-3958-32*

Vetro temperato con filtro food rosato
Pink tempered glass for food application

* Accessories to be used only with snoot code 28-3957-30





Floot

design: **Enrico Davide Bona e Elisa Nobile**

Floot è una lampada a sospensione a luce diffusa con sorgente LED COB monodirezionale che si distingue per la sobrietà delle linee e il rigore funzionale. Un design attuale, elegante ma allo stesso tempo innovativo, fa di **Floot** una presenza visibile ma leggera, per ambienti privati e pubblici. Il vano componenti, che agisce anche da raffreddatore, si abbina al diffusore traslucido a campana, segno lineare ed essenziale che determina l'eleganza e la leggerezza sofisticata dell'apparecchio. Sono disponibili come accessori ottiche professionali a fascio più stretto. L'apparecchio può essere sospeso su binari elettrificati trifase LKM con specifici adattatori.

Materiali:

- Vano componenti in pressofusione di alluminio verniciato poliesteri
- Diffusore a campana in policarbonato traslucido
- Rosone in alluminio pressofuso verniciato poliesteri
- Ottiche professionali in termoplastico ad alta resistenza
- Cavi di sospensione in acciaio da 2 mt, regolabili con dispositivi automatici

Floot is a single light suspended luminaire equipped with a COB LED source and with a smooth light distribution. Its design is clean and sober, modern and elegant, but at the same time innovative, to make the fitting light and visible, ideal both for private and for public areas. The gear box, designed to achieve a passive heat dissipation, is matched with the frosted bell-shaped diffuser, defining the sophisticated appeal of this fitting. Professional optics are available on demand as accessories, for a narrower beam angle. **Floot** can be suspended on LKM 3-phase tracks through the proper adapters.

Materials:

- Gear box in die-cast aluminium, polyester painted
- Bell-shaped diffuser in translucent polycarbonate
- Ceiling base in die-cast aluminium, polyester painted
- Professional optics in high resistant thermoplastic material
- Suspension wires in steel, 2 meters long, adjustable with automatic devices

Modello di design depositato / Registered design model

FLOOT



06 Bianco / Traslucido
White / Translucent

Codice Code	LED Lumen	Product Lumen	Watt	Colour T (K)	CRI	Fascio Beam
3915-01	6800	5873	51	3000	85	70°
3916-01	4800	4258	33	3000	85	70°

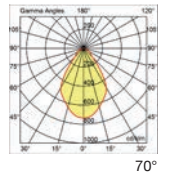
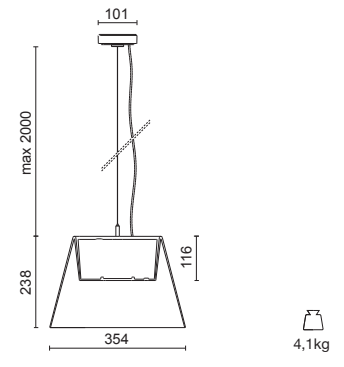

220/240V - 50/60Hz

CE IP20 IK06

Accessori ottici intercambiabili
Replaceable optical accessories



28-3140-51

Ottica professionale S
Professional optic device S

33W 51W

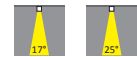

28-3142-51

Ottica professionale M
Professional optic device M

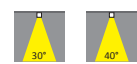

28-3138-51

Ottica professionale W
Professional optic device W

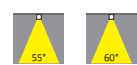

28-3141-31

Ottica professionale XW
Professional optic device XW

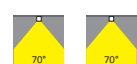

28-3957-30

Cilindro antiabbagliamento
Snoot



28-3959-30*

Frangiluce alveolare
Honeycomb



28-3958-58*

Vetro temperato trasparente
Clear tempered glass

* Accessori da utilizzare esclusivamente insieme a snoot cod. 28-3957-30



28-3958-32*

Vetro temperato con filtro food rosato
Pink tempered glass for food application

* Accessories to be used only with snoot code 28-3957-30

Adattatori per binari trifase LKM
Adapters for LKM 3-phase tracks



7600-00

Adattatore elettromeccanico 6A, portata 10kg
Electro/mechanical adapter 6A, load 10kg

31



7618-00

Adattatore meccanico con bloccacavo
Mechanical adapter with automatic locking device

31





Sofi 301

design: **Enrico Davide Bona e Elisa Nobile**

Sofi 301 è un apparecchio a sospensione dal design minimale e compatto, con sistema di dissipazione termica passiva.

Si adatta a molteplici contesti in cui sia richiesta un'alta performance qualitativa come negozi, uffici, spazi collettivi e residenziali.

Equipaggiato con la nuova sorgente di luce a LED COB ad alta intensità luminosa ed elevato rendimento, con notevole risparmio energetico, **Sofi 301** abbina un'estetica moderna e lineare ad un aspetto tecnologico, che si traduce in grande efficienza luminosa.

Materiali:

- Corpo e rosone in pressofusione di alluminio verniciato poliester
- Riflettore sfaccettato in termoplastico ad alta resistenza, metallizzato a specchio
- Schermo diffusore in policarbonato traslucido
- Cavi in acciaio da 2000 mm regolabili con dispositivi automatici

Sofi 301 is a suspended luminaire with a minimal and compact design, provided with an innovative system of passive heat dissipation. It is the perfect solution for a number of applications where a high quality performance is required, such as shops, offices, public and domestic areas.

Sofi 301 is equipped with the new COB LED source combining high performance, high efficiency and high energy savings. Its modern and linear shape, combined with its hi-tech look, results in an outstanding level of luminous efficiency.

Materials:

- Housing and canopy in die-cast aluminium, polyester painted
- High resistant faceted mirror metallized thermoplastic reflector
- Diffuser in translucent polycarbonate
- Steel wires, 2000 mm long, adjustable through automatic devices

Modello di design depositato / Registered design model

SOFI 301

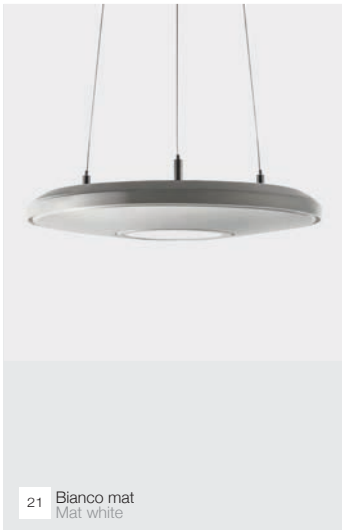

21 Bianco mat
Mat white

Codice Code	LED Lumen	Product Lumen	Watt	Colour T (K)	CRI	Fascio Beam
3890-02	4800	4204	33	3000	85	60°

230/240V - 50/60Hz

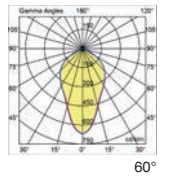
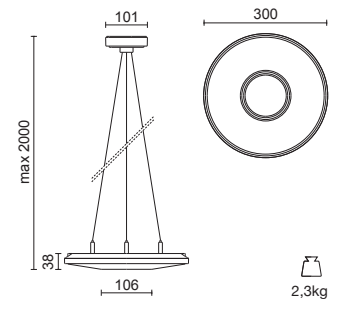



Aplomb 350 LED

design: **Bruno Gecchelin**

Aplomb 350 è un apparecchio a sospensione con LED COB ad alta potenza in grado di abbinare l'eleganza nel design all'efficace caratterizzazione degli spazi da illuminare. **Aplomb 350** sa integrarsi in molteplici ambienti creando suggestive regie luminose grazie alle diverse possibilità di installazione.

Aplomb 350 è particolarmente adatto non solo all'illuminazione di showroom, corridoi, open space, uffici, negozi o abitazioni, ma risponde anche alle necessità di illuminazione in ambienti spaziosi, come centri commerciali, hall di alberghi, sale d'attesa.

Può essere applicato a sospensione con cavo d'acciaio oppure su binari elettrificati trifase utilizzando gli appositi adattatori.

Materiali:

- Corpo in pressofusione di alluminio verniciato poliester
- Diffusore in policarbonato metallizzato internamente con verniciatura esterna
- Vetro di protezione temprato 4mm, con anello in tecnopolimero
- Rosone in alluminio pressofuso completo di cavo di acciaio da 2 mt

Aplomb 350 is a suspended luminaire with high power COB LED capable of combining design elegance with high lighting performance. **Aplomb 350** can be integrated in multiple environments, creating suggestive lighting effects thanks to the different installation possibilities.

Aplomb 350 is ideal not only for showrooms, corridors, open spaces, offices, shops or home lighting, but it also meets the lighting requirements of large areas such as shopping centres, hotel halls and waiting rooms.

It can be suspended with a steel wire, or it can be installed on 3-phase tracks using the adapters designed for the purpose.

Materials:

- Body in die-cast aluminium, polyester painted
- Diffuser in polycarbonate, metal coated inside with external painting
- 4 mm tempered safety glass with technopolymer ring
- Ceiling canopy in die-cast aluminium complete with 2 mt steel wire

Modello di design depositato / Registered design model

APLOMB 350 LED



Codice Code	LED Lumen	Product Lumen	Watt	Colour T (K)	CRI	Fascio Beam
406-011	2000	1785	22	3000	80	80°

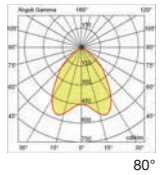
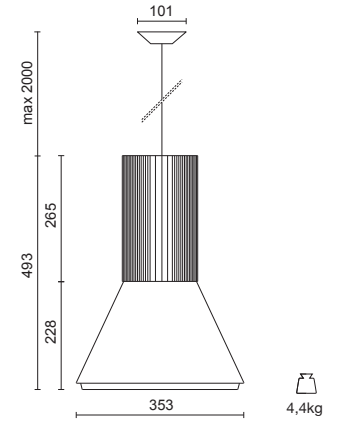

220/240V - 50/60Hz

CE 850° IP20 A+ A+ A



Adattatori per binari trifase LKM Adapters for LKM 3-phase tracks



7600-00

Adattatore elettromeccanico 6A, portata 10kg
Electro/mechanical adapter 6A, load 10kg

31 30 52



7618-00

Adattatore meccanico con bloccacavo
Mechanical adapter with automatic locking device

31 30 52





Boma Led-S

design: **Enrico Davide Bona e Elisa Nobile**

Boma LED nella versione a sospensione è un apparecchio d'illuminazione dalle linee essenziali, perfettamente integrabile in ogni ambiente.

Pensato e progettato per LED ad alta efficienza e risparmio energetico, **Boma LED** è la soluzione ideale in uffici, reception o spazi collettivi dove sia richiesta una luce di elevata qualità senza abbagliamento.

Lo schermo in policarbonato opale garantisce infatti una perfetta e uniforme diffusione della luce e un elevato livello di confort visivo. Disponibile in versione con adattatori per binari elettrificati trifase.

Materiali:

- Corpo in estruso di alluminio verniciato poliester
- Diffusore in policarbonato opale, stabilizzato ai raggi UV e antiurto
- Riflettore porta cablaggio in estruso di alluminio verniciato poliester
- Chiusure laterali in nylon caricato F.V.30% verniciato a liquido
- Rosoni in pressofusione di alluminio verniciato poliester, con cavi in acciaio lunghezza 2000 mm e dispositivi automatici per la regolazione della lunghezza

The suspended version of **Boma LED** is a lighting fitting with essential lines that can perfectly fit every kind of space.

Designed for high efficient and energy saving LEDs, **Boma LED** is the ideal solution in offices, receptions or collective spaces where a high quality and anti-dazzle lighting is needed. The opal polycarbonate diffuser grants a perfect and uniform light distribution and a high level of visual comfort.

Version with adapter for 3-phase electrified tracks is available.

Materials:

- Housing in extruded aluminium, polyester-painted
- Opal polycarbonate diffuser, UV stabilized and shockproof
- Gear-tray in extruded aluminium, polyester painted
- Canopies in die-cast aluminium, polyester painted, complete with steel wires of 2000 mm and automatic devices for length adjustment

Modello di design depositato / Registered design model
Modello di Utilità brevettato / Patented as Utility model

BOMA LED-S



08 Bianco
White

Codice Code	LED Lumen	Product Lumen	Watt	Colour T (K)	CRI	Fascio Beam
453-210	5000		35	3000	85	

Versione per binari elettrificati, vedi pag.77 - Versione con base vedi pag. 197
Version for electrified tracks, see page 77 - Version with base, see page 197

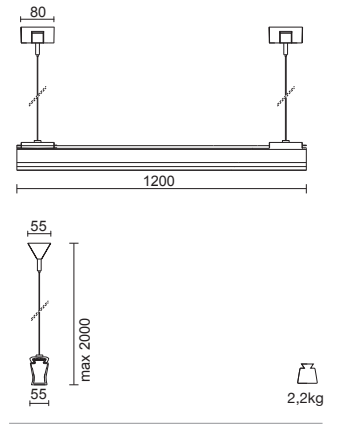

Adattatori per binari trifase LKM Adapters for LKM 3-phase tracks



7600-00

Adattatore elettromeccanico 6A, portata 10kg
Electro/mechanical adapter 6A, load 10kg

31



7618-00

Adattatore meccanico con bloccacavo
Mechanical adapter with automatic locking device

31





Zeppel 400

Studio Tecnico Ivela

Zeppel 400 è idoneo per l'installazione in grandi aree, come strutture commerciali, negozi, magazzini, aree espositive. Il suo design classico e ben proporzionato lo rende adatto anche per illuminare abitazioni private, loft, studi professionali.

Apparecchio fornito completo di lampade fluorescenti compatte elettroniche a elevata potenza per un concreto risparmio di energia e un'alta emissione luminosa. È possibile l'applicazione della sospensione **Zeppel 400** ai binari trifase utilizzando gli appositi adattatori.

Materiali:

- Vano componenti in tecnopolimero nero o verniciato metal
- Riflettore in policarbonato traslucido o metallizzato internamente con verniciatura esterna
- Schermo di protezione in vetro temprato 4mm antiabbagliante, resistente agli urti e agli shock termici, fissato al riflettore con ganci in tecnopolimero

Zeppel 400 is suitable for installation in large areas such as commercial buildings, shops, warehouses, and display areas. Its classic and well-balanced design also makes it ideal for the illumination of private homes, lofts, and offices.

The fitting is equipped with high power electronic compact fluorescent lamps, for real energy saving and high luminous output (for code 430-111 and 433-111). The **Zeppel 400** suspension can be installed on three-phase tracks using the specific adapters.

Materials:

- Black or silver painted technopolymer gear housing
- Polycarbonate reflector in translucent finish or with a metallized interior finish and a silver external paint
- Safety screen in 4mm tempered glass, anti-glare, shockproof and thermal resistant, fastened to the reflector by technopolymer clips

ZEPPEL 400



Codice Code	Lampada Lamp	Watt	Colour T (K)	Attacco Base	Fascio Beam
430-111-26	FSMH incl.	57	3000	Gx24q-5	110°
430-111-33	FSMH incl.	57	3000	Gx24q-5	110°
433-111-26	FSMH incl.	70	3000	Gx24q-6	35° IP43/20
433-111-33	FSMH incl.	70	3000	Gx24q-6	35° IP43/20
433-111-38	FSMH incl.	70	3000	Gx24q-6	35° IP43/20
439-011-26	FBT 23W/HE100W	-	-	E27	-
439-011-27	FBT 23W/HE100W	-	-	E27	-
439-011-33	FBT 23W/HE100W	-	-	E27	-
439-011-38	FBT 23W/HE100W	-	-	E27	-

57W/70W: 230/240V - 50/60Hz

CE IP44 IK08

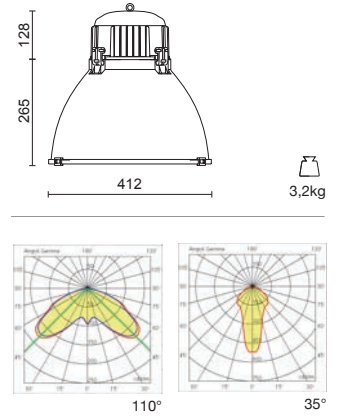

160976

Kit di sospensione con rosone traslucido, cavo acciaio 2000mm, cavo alimentazione 2x0,75mm²
Suspension kit with translucent canopy, steel wire 2000mm, supply cable 2x0,75mm²

Adattatori per binari trifase LKM Adapters for LKM 3-phase tracks



7600-00

Adattatore elettromeccanico 6A, portata 10kg
Electro/mechanical adapter 6A, load 10kg

31 30 52



7618-00

Adattatore meccanico con bloccacavo
Mechanical adapter with automatic locking device

31 30 52





PF 9
p.190



PF 15
p.190



PF 22
p.191



PF Line
p.191



PF 10
p.192



PF 19
p.192



PF 19
p.192



PF 30
p.193



San 35 LED
p.195



Boma LED
p.197



Luci da plafone

CEILING LIGHTS



Serie PF

design: **Enrico Davide Bona e Elisa Nobile**

La serie delle **plafoniere PF** è stata progettata espressamente per la tecnologia a LED COB di ultima generazione, garantendo una qualità della luce dalle elevate prestazioni.

Tutta la gamma è caratterizzata da un profilo particolarmente sottile e da forme geometriche essenziali quali il cerchio, il quadrato e il rettangolo, che le consentono di essere ambientata in spazi, anche con altezze ridotte, a soffitto o a parete, in ambiti sia residenziali che pubblici.

Costituisce un'alternativa ai punti luce ad incasso, con evidenti economie di installazione.

PF 9 e **PF 10** sono proposte con LED a tensione di rete a 230V senza necessità di driver.

The range of **PF ceiling** luminaires has been specially designed to be equipped with COB LED sources of last generation, for high quality and high performance in lighting. The whole range is extremely shallow, featuring essential geometric shapes such as the circle, the square and the rectangle, thus it is ideal for a number of applications including low ceilings, both in public and residential areas.

It is a good alternative to downlights, with low installation costs.

PF 9 and **PF 10** are supplied for direct connection to mains voltage 230V without driver.

Modelli di design depositato / Registered design models





Materiali:

- Corpo in pressofusione di alluminio verniciato poliester
- Riflettore sfaccettato in termoplastico ad alta resistenza, metallizzato a specchio ad alto vuoto (per alcune versioni di PF 30 e PF 19)
- Diffusore in policarbonato opale ad alta capacità diffondente (su alcune versioni)

Materials:

- Body in die-cast aluminium, polyester painted
- Faceted reflector in thermoplastic material, high resistant and mirror-metallized in high vacuum (for some versions of PF 30 and PF 19)
- Opal polycarbonate diffuser with high light-diffusion capacity (only on some versions)



PF 9 e PF 10 sono plafoniere di minime dimensioni, non necessitano di driver poiché equipaggiate con LED a tensione di rete.



PF 9 and PF 10 are ceiling mounted luminaires extremely compact in size due to the absence of driver - the LED connects directly to mains voltage.



PF 9



21 Bianco mat
Mat white

52 Metal su richiesta
Silver on demand

Codice Code	LED Lumen	Product Lumen	Watt	Colour T (K)	CRI	Fascio Beam
3824-01	400	306	4,3	3000	80	110°

Con LED a tensione di rete
With supply voltage LED

230V - 50/60Hz

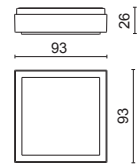

0,2kg

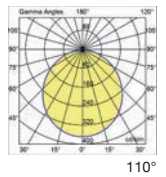

110°

PF 15



21 Bianco mat
Mat white

52 Metal su richiesta
Silver on demand

3825-01	1700	1088	12	3000	85	110°
----------------	------	------	----	------	----	------

220/240V - 50/60Hz

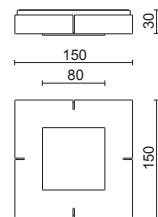

0,7kg

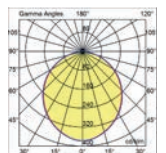

110°

PF 22



21 Bianco mat
Mat white

Codice Code	LED Lumen	Product Lumen	Watt	Colour T (K)	CRI	Fascio Beam
3830-01	2400	1721	18	3000	85	110°
3831-01	3400	2448	26	3000	85	110°

220/240V - 50/60Hz

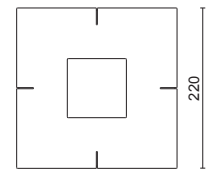
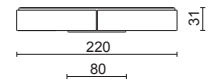

1,2kg

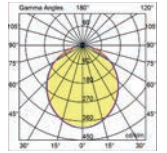

110°

PF LINE



21 Bianco mat
Mat white

3894-01	2600	2131	30	3000	85	115°
----------------	------	------	----	------	----	------

Versione con attacco per parete, vedi pag. 211
Wall mounted version, see page 211

220/240V - 50/60Hz

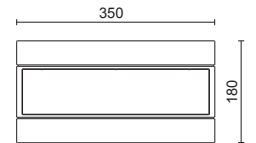
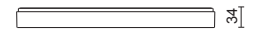

1,4kg

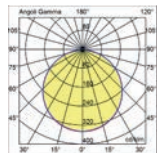

115°

PF 10



21 Bianco mat
Mat white

52 Metal su richiesta
Silver on demand

Codice Code	LED Lumen	Product Lumen	Watt	Colour T (K)	CRI	Fascio Beam
3875-01	400	306	4,3	3000	80	110°

Con LED a tensione di rete
With supply voltage LED

230V - 50/60Hz

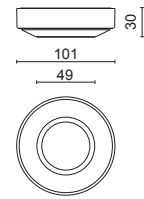

0,3kg

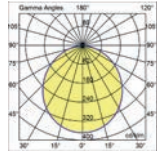

110°

PF 19



21 Bianco mat
Mat white

52 Metal su richiesta
Silver on demand

Con riflettore 120°
With 120° reflector

3880-01	1800	1538	12	3000	85	120°
----------------	------	------	----	------	----	------

Dimmerabile sul taglio di fase
Dimmable on the mains

230/240V - 50/60Hz

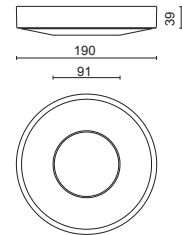

0,7kg

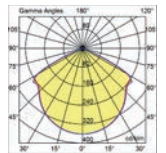

120°

PF 19



21 Bianco mat
Mat white

52 Metal su richiesta
Silver on demand

Con schermo diffusore
With diffuser

3881-01	1800	1152	12	3000	85	110°
----------------	------	------	----	------	----	------

Dimmerabile sul taglio di fase
Dimmable on the mains

230/240V - 50/60Hz

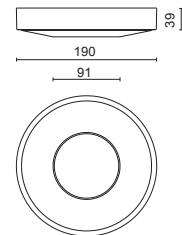

0,7kg

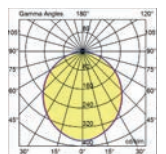

110°

PF 30



21 Bianco mat
Mat white

52 Metal
Silver

Codice Code	LED Lumen	Product Lumen	Watt	Colour T (K)	CRI	Fascio Beam
Con schermo diffusore With diffuser						
3887-01	2550	1785	18	3000	85	100°
3888-02	3400	2448	26	3000	85	100°

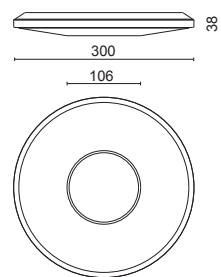

1,5kg

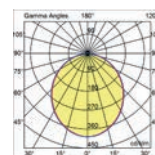

CE 850° IP40 A+ A+ A



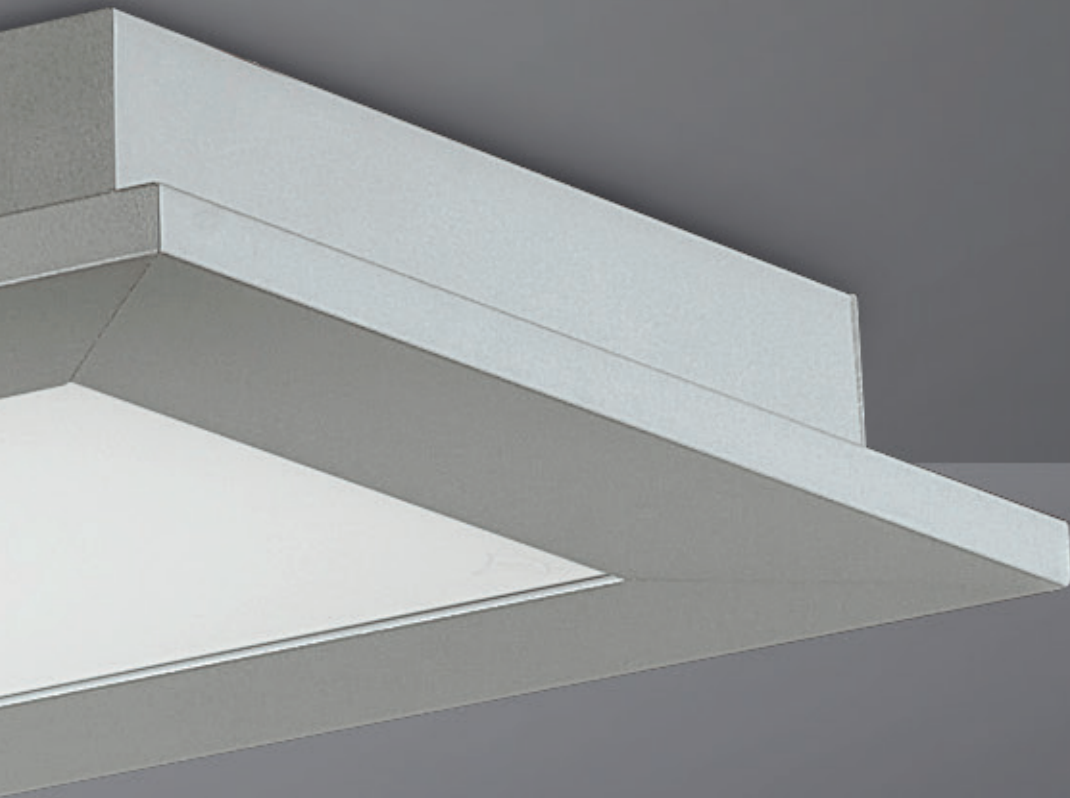

San 35 LED

Studio Tecnico Ivela

La plafoniera **San 35 LED** è ideale per illuminare ambienti di lavoro quali uffici, banche, atri, sale convegno, sale d'attesa o aree di passaggio. Il design dalle linee essenziali rende **San 35 LED** applicabile anche in ambienti domestici.

Una soluzione semplice ma efficace per assicurare un ottimo livello d'illuminamento con basso consumo energetico e un elevato comfort visivo.

Apparecchio per applicazioni a parete oppure a soffitto: le apposite asole di fissaggio e la morsetteria a innesto automatico rendono l'installazione estremamente semplice e veloce. Il vetro di protezione è sfilabile lateralmente.

Materiali:

- Corpo interno in acciaio verniciato
- Cornice in alluminio estruso verniciato in poliester
- Vetro diffusore acidato e serigrafato

San 35 LED ceiling light is ideal for working environments, such as offices, banks, schools, lobbies, meeting rooms, waiting rooms or passageways. The essential design makes **San 35 LED** suitable also for domestic use.

A simple but effective solution to ensure an optimum level of energy saving illumination and high visual comfort. Fitting for wall or ceiling application: the special fixing slots and the terminal block with automatic plug-in make the installation extremely simple and fast. The safety glass can be removed by sliding it out to one side.

Materials:

- Painted inner steel body
- Extruded aluminium frame, polyester painted
- Acid-etched, silk-screen printed glass

Modello di design depositato / Registered design model



SAN 35 LED



21 Bianco mat su richiesta
Mat white on demand

52 Metal
Silver

Codice Code	LED Lumen	Product Lumen	Watt	Colour T (K)	CRI	Fascio Beam
3803-01	1700		12	3000	85	110°
3804-01	2400		18	3000	85	110°

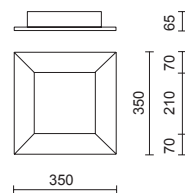

 3,6kg

220/240V - 50/60Hz

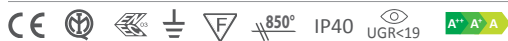

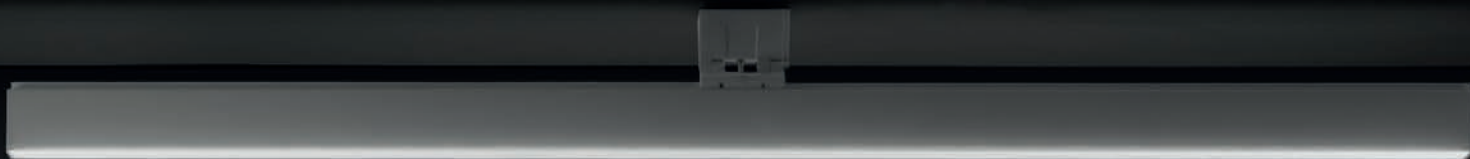

Boma Led

design: **Enrico Davide Bona e Elisa Nobile**

Boma LED per applicazioni a parete e a soffitto è la soluzione ideale per realizzare un'illuminazione omogenea, flessibile ed efficace valorizzando, con elevato comfort, anche aree di grandi dimensioni quali centri commerciali, esposizioni, uffici open space, negozi, spazi di servizio collettivo.

La base di fissaggio consente di regolare l'apparecchio con una rotazione verticale di 180°: in questo modo **Boma LED** può assumere posizioni differenti in funzione della distribuzione della luce. Disponibile versione con adattatore per binari elettrificati trifase LKM e versione a sospensione.

Materiali:

- Corpo in estruso di alluminio verniciato poliester
- Diffusore in policarbonato opale, stabilizzato ai raggi UV e antiurto
- Riflettore porta cablaggio in estruso di alluminio verniciato poliester bianco
- Chiusure laterali in nylon caricato F.V.30% verniciato a liquido
- Viteria in acciaio

Boma LED is the ideal solution to create a uniform, flexible and effective illumination. It is able to enhance areas with a large size such as shopping malls, display areas, open plan offices, shops, collective service areas, with a high visual comfort.

The adjustable base allows the regulation of the fitting through a rotation up to 180°, for the control of the lighting distribution, according to the position of the fittings.

A version with adapter for LKM 3-phase electrified tracks and a suspended version are also available.

Materials:

- Housing in extruded aluminium, polyester-painted
- Opal polycarbonate diffuser, UV stabilized and shockproof
- Gear-tray in extruded aluminium, polyester painted in white
- Closing caps in nylon, reinforced with fiberglass 30%, liquid painted
- Steel screws

Modello di design depositato / Registered design model



BOMA LED



Codice Code	LED Lumen	Product Lumen	Watt	Colour T (K)	CRI	Fascio Beam
453-120	4000	-	30	3000	80	110°

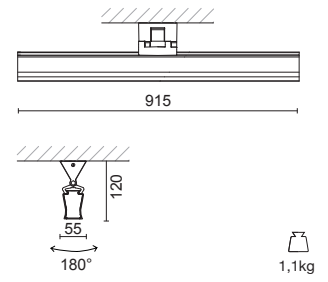

Versione per binari elettrificati, vedi pag. 77 - Versione a sospensione, vedi pag. 181
 Version for electrified tracks, see page 77 - Suspended version, see page 181

220/240V - 50/60Hz





Minikyclos-KP
p.203



Giada
p.207



Giada
p.207



Giada 200
p.207



AP Line
p.211



Quadro
p.212



Beta
p.213



Crio
p.213

Luci da parete

WALL LIGHTS



Minikyclos-KP

design: **Enrico Davide Bona e Elisa Nobile**

Minikyclos-KP è un apparecchio per l'illuminazione multidirezionale per applicazione a parete oppure a soffitto, equipaggiato con LED COB ad alta efficienza di ultima generazione, ideale laddove sia richiesta luce d'accento in vetrine, spazi commerciali ed espositivi, gallerie d'arte.

L'apparecchio, dal design sobrio ed essenziale, prevede due corpi illuminanti indipendenti tra loro e completamente orientabili (355°) grazie agli snodi meccanici che li collegano al telaio, anch'esso regolabile fino a 180°. Il prodotto, orientato a filo parete, occupa uno spazio molto ridotto e si adatta con discrezione a svariate necessità di illuminazione.

Minikyclos-KP is a wall-or ceiling mounted fitting for multidirectional lighting, equipped with the last generation of high efficiency COB LEDs, ideal for shop-windows, sales and exhibition areas where accent lighting is required.

The fitting, with its sober and essential design, consists of two independent luminaires that can rotate through 355°, while the frame can pivot through 180°.

This allows the installation flush on the wall, taking a limited space, with a low visual impact, making it suitable for different lighting needs.

Modello di design depositato / Registered design model



**Materiali:**

- Corpi illuminanti in pressofusione di alluminio verniciato poliестere
- Ottiche professionali in termoplastico metallizzato a specchio
- Frontale di chiusura in policarbonato trasparente, retroverniciato per un effetto brillante, senza viti a vista
- Telaio e base in alluminio verniciato poliестere

Materials:

- Bodies in die-cast aluminium, polyester painted
- Reflectors in thermoplastic material, mirror-metallized
- Front screen in clear polycarbonate, rear painted, without visible screws
- Frame and base in aluminium, polyester painted



MINIKYCLOS-KP



21 Bianco mat
Mat white

Codice Code	LED Lumen	Product Lumen	Watt	Colour T (K)	CRI	Fascio Beam
506-221	2x2500	2x2250	2x18	3000	85	30°

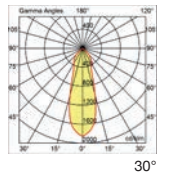
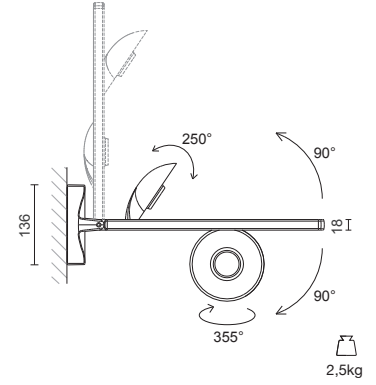
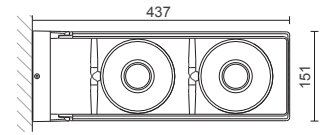

230/240V - 50/60Hz

CE 850° IP20 A+ A+ A





Giada

design: **Enrico Davide Bona e Elisa Nobile**

La serie di applique **Giada** nasce dall'esigenza di realizzare apparecchi con design innovativo, in grado di ospitare le nuove sorgenti LED COB ad alta potenza, con un sistema di dissipazione termica passiva.

Due i modelli progettati: **Giada** rappresenta il perfetto connubio tra miniaturizzazione ed alta efficienza; **Giada 200** ha dimensioni più grandi ed integra LED di potenza elevata, per prestazioni illuminotecniche ottimali.

Giada e Giada 200 si inseriscono con eleganza in una grande varietà di ambienti e risultano ideali anche nel settore contract. La loro speciale forma si adatta alla parete in maniera discreta e accattivante, ottenendo una diffusione luminosa piacevole e funzionale.

I fori nella parte superiore e inferiore dell'apparecchio sono stati ideati per enfatizzare il colore della parete retrostante e per creare giochi di luce di grande effetto scenografico.

The **Giada** range of wall luminaires have been developed to use the new powerful COB LED sources in an innovative design, with a passive heat dissipation.

The fitting is available in two models: **Giada** is the ideal combination of miniaturization and high efficiency; while **Giada 200** has a larger size and it is equipped with high power LEDs, for optimal lighting performance.

Giada and **Giada 200** can be elegantly proposed in a wide range of applications, including contract specifications. Their special shape fits on the wall with a sober and appealing look, providing a pleasant and functional light diffusion.

The holes in the upper and lower parts of the fitting have been designed to emphasize the colour of the wall behind, and to create scenic light effects.

Modello di design depositato / Registered design model

Materiali:

- Corpo e attacco a parete in pressofusione di alluminio verniciato poliestere

Materials:

- Body and wall bracket in die-cast aluminium, polyester painted

Giada prevede due LED, per luce bidirezionale diretta e indiretta e un LED per luce monodirezionale.

Giada 200 è disponibile nelle versioni bidirezionale a doppia accensione oppure monodirezionale.

Il corpo, ruotabile di +/- 12° rispetto al piano verticale, permette di orientare il fascio luminoso emesso.

Giada is available in a two-LED version for bi-directional indirect-direct light, and in a one-LED version for monodirectional light.

Giada 200 is available in a bi-directional double switch or in a single light version.

The body can pivot by +/- 12°, with the possibility of pointing the luminous flux accordingly.



GIADA



21 Bianco mat
Mat white

52 Metal su richiesta
Silver on demand

Codice Code	LED Lumen	Product Lumen	Watt	Colour T (K)	CRI	Fascio Beam
Monodirezionale Single light						
3740-01	1x3850	1x3350	1x30	3000	85	110°

230/240V - 50/60Hz

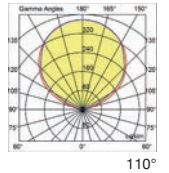
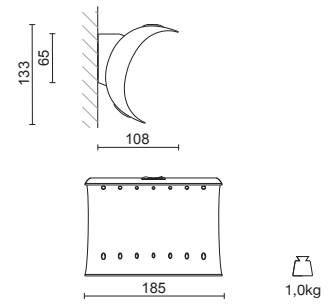

GIADA



21 Bianco mat
Mat white

52 Metal su richiesta
Silver on demand

Codice Code	LED Lumen	Product Lumen	Watt	Colour T (K)	CRI	Fascio Beam
Bidirezionale Bi-directional						
3735-01	2x1800	2x1566	2x12	3000	85	110°/ 110°

230/240V - 50/60Hz

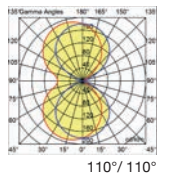
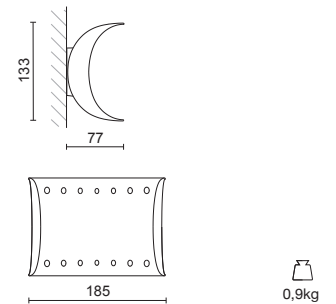

GIADA 200



21 Bianco mat
Mat white

52 Metal su richiesta
Silver on demand

Codice Code	LED Lumen	Product Lumen	Watt	Colour T (K)	CRI	Fascio Beam
Bidirezionale a doppia accensione Bi-directional double switch						
3741-01	6800+1800	6327+1673	51+12	3000	85	115°/115°

Codice Code	LED Lumen	Product Lumen	Watt	Colour T (K)	CRI	Fascio Beam
Monodirezionale Single light						
3743-01	6800	6327	51	3000	85	115°

230/240V - 50/60Hz

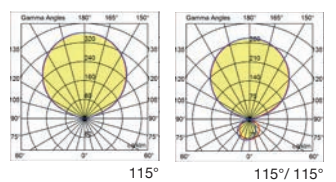
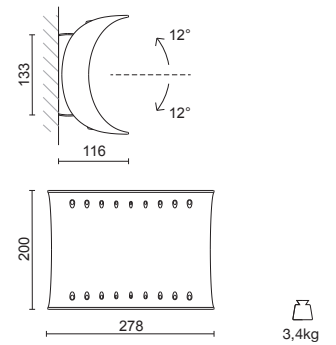



AP Line

design: **Enrico Davide Bona e Elisa Nobile**

Applique a luce indiretta geometrica e dai tratti rigorosi, **AP Line** è progettata per sorgenti luminose a LED COB di ultima generazione, che associano un'elevata potenza a consumi energetici ridotti.

La sua forma a parallelepipedo, estremamente sottile, ben si presta ad essere inserita quale elemento illuminante in numerosi ambienti. È un apparecchio studiato per spazi collettivi e privati (quali strutture ricettive, saloni e ingressi).

Lo schermo diffusore di **AP Line** rende uniforme la luce emessa e garantisce elevati standard di comfort visivo. Il corpo dell'apparecchio, oltre ad essere elemento estetico elegante, serve anche a dissipare passivamente il calore irradiato dal LED.

AP Line is a wall light for indirect lighting with a geometric and sober design, for COB LED sources of last generation, that combine high power and low energy consumption.

Its special parallelepiped shape is ideal for applications in a number of places. It is a luminaire ideal for private or public spaces, such as hospitality halls and entrances.

The **AP Line** diffuser is designed to provide a uniform light distribution and high visual comfort. The fitting's body, in addition to its elegant aesthetic value, ensures passive dissipation of the heat generated by the LED source.

Modello di design depositato / Registered design model

Materiali:

- Corpo e staffa in pressofusione di alluminio
- Schermo diffusore in policarbonato opale ad alta capacità diffondente

Materials:

- Body and bracket in die-cast aluminium
- Diffuser in opal polycarbonate with high light-diffusion capacity



AP LINE

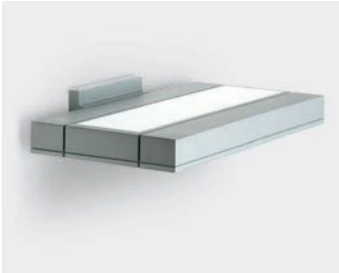

21 Bianco mat
Mat white

52 Metal
Silver

Codice Code	LED Lumen	Product Lumen	Watt	Colour T (K)	CRI	Fascio Beam
3748-01	2600	2131	30	3000	85	110°

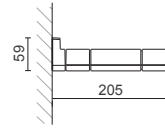
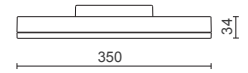

1,8kg

220/240V - 50/60Hz

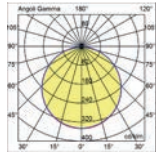

110°



Quadro

Studio Tecnico Ivela

Design assolutamente essenziale, massima semplicità e purezza geometrica rendono questa applique da parete molto versatile in ambienti pubblici e residenziali.

Corpo in acciaio verniciato bianco

Profili laterali in estruso d'alluminio spazzolato, verniciato poliestere

Diffusore in vetro serigrafato bianco (3 mm)

The absolutely essential design, the maximum simplicity and the geometric lines make this wall lamp very versatile in different applications, both in public and in residential areas.

White painted steel body and wall-bracket

Side profiles in extruded brushed aluminium, polyester painted

White silk-screen printed glass diffuser (3 mm)

QUADRO



Codice Code	Lampada Lamp	Watt	Colour T (K)	Attacco Base
3772-21-90	FSQ incl.	2x18	4000	G24d-2
3776-21-90	FBT incl.	2x20	4000	E27

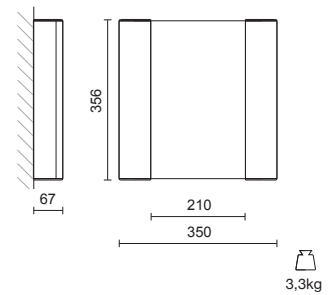

18W: 230V - 50/60Hz



Beta & Crio

Studio Tecnico Ivela

Beta & Crio sono due modelli di applique dal design sobrio capaci di integrarsi con eleganza in ambienti domestici o pubblici, come alberghi, ristoranti, bar, anche nel settore contract.
Vetro curvato, serigrafato bianco internamente e sabbiato esternamente
Attacco a parete in tecnopolimero bianco

Beta & Crio with their sober lines, are two models of wall lamps, able to be elegantly integrated in residential spaces or in public buildings such as hotels, restaurants and pubs, also in specifications.
Curved glass, internally silk-screen printed in white and externally sandblasted
White technopolymer wall bracket

BETA



Codice Code	Lampada Lamp	Watt	Attacco Base
3762-B-150	HE	150	E27

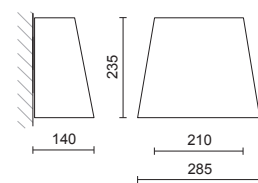

1,1kg



CRIO



3762-C-150	HE	150	E27
------------	----	-----	-----

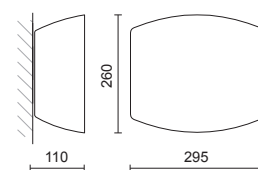

1,2kg



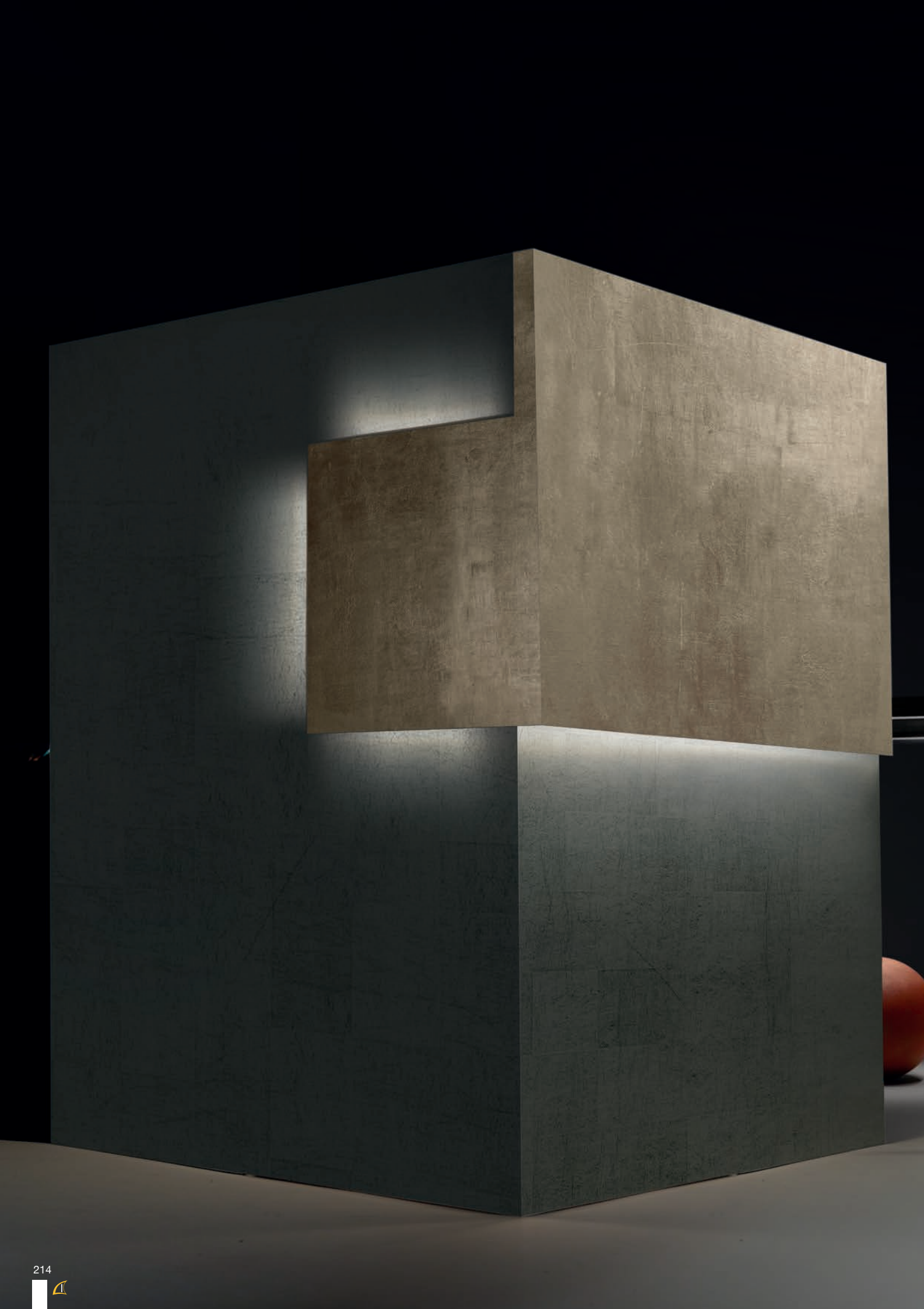

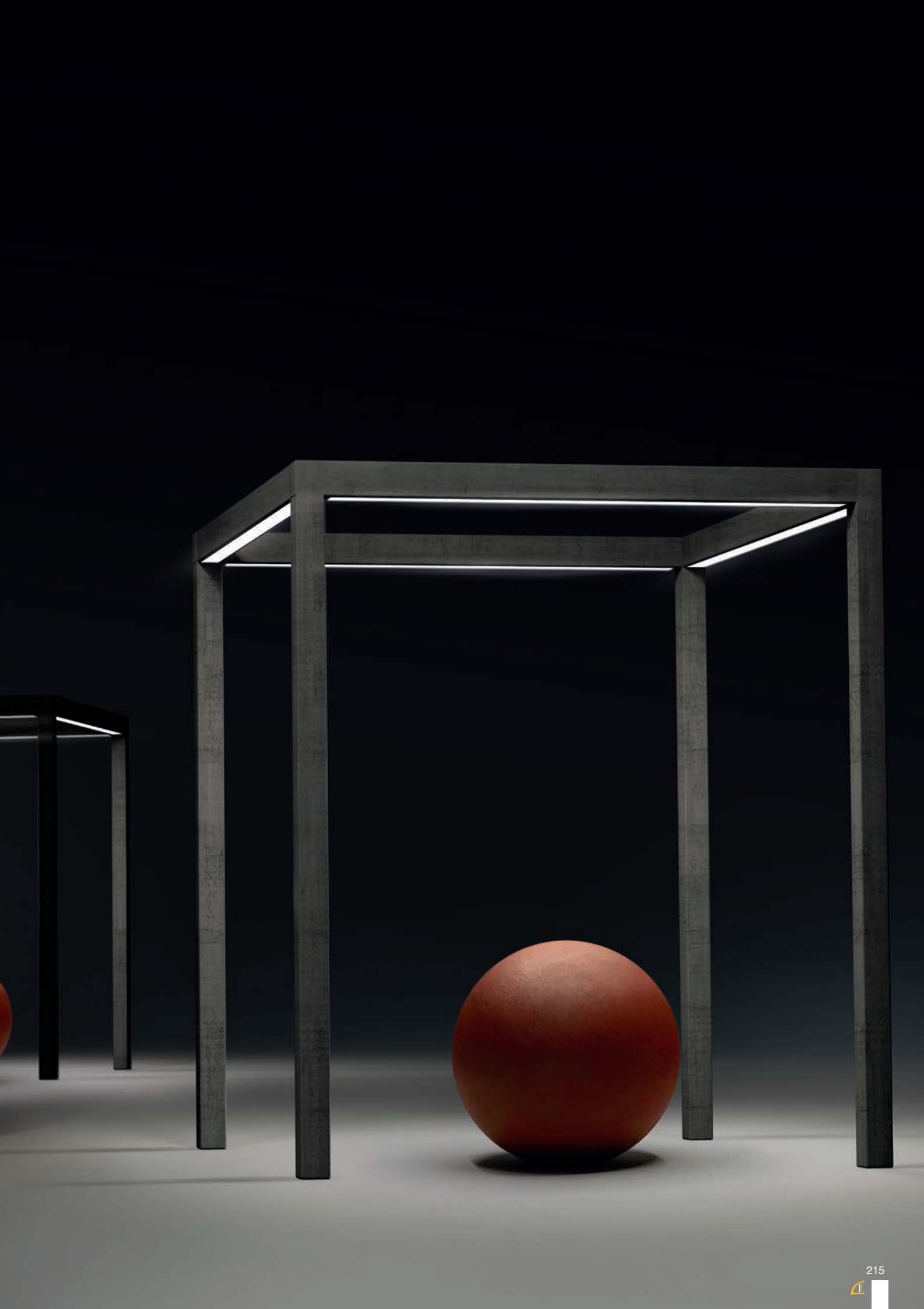



Profile surface
p.219



Profile recessed
p.219

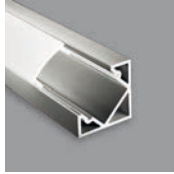

Profile corner
p.219



Striped 24V
p.221



Striped Bender light
p.223



Luci lineari

LINEAR LIGHTS



Profili Profiles

Profili in lega di alluminio estruso anodizzato ideali per l'installazione di stripled. Ogni profilo è indicato per una specifica applicazione.

Diffusori in policarbonato resistente: opale o trasparente
Accessori: tappi di chiusura e ganci di fissaggio
Lunghezza standard dei profili: 2 mt

Profiles made of extruded anodized aluminium alloy, ideal for LED strip mounting. Each profile is designed for a specific application.

Covers in high resistant polycarbonate: opal or clear
Accessories: closing caps and mounting clips
Profiles standard length: 2 mt



38 SURFACE



Codice Code	Profile colour	Cover colour
Completi di 4 ganci di fissaggio e 4 tappi di chiusura (2+2) Complete with 4 fixing clips and 4 closing caps (2+2)		
K7382-S04-4262	Anodizzato - Anodized	Opale - Opal
K7382-S04-4247	Anodizzato - Anodized	Trasparente - Clear

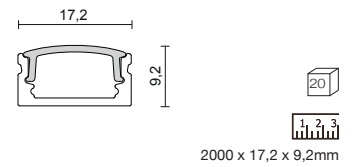

39 RECESSED



Codice Code	Profile colour	Cover colour
Completi di 4 ganci di fissaggio e 4 tappi di chiusura (2+2) Complete with 4 fixing clips and 4 closing caps (2+2)		
K7392-R04-4262	Anodizzato - Anodized	Opale - Opal
K7392-R04-4247	Anodizzato - Anodized	Trasparente - Clear

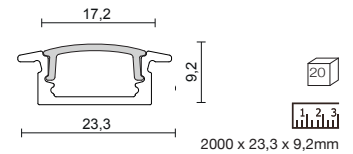

40 CORNER



Codice Code	Profile colour	Cover colour
Completi di 4 ganci di fissaggio e 4 tappi di chiusura (2+2) Complete with 4 fixing clips and 4 closing caps (2+2)		
K7402-C04-4262	Anodizzato - Anodized	Opale - Opal
K7402-C04-4247	Anodizzato - Anodized	Trasparente - Clear

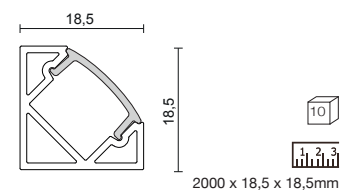

Accessori Accessories

84-90380-51	Kit di ricambio con 4 ganci di fissaggio e 4 tappi di chiusura grigi (2+2) per Profilo 38 Surface Spare parts kit with 4 fixing clips and 4 gray closing caps (2+2) for Profile 38 Surface
84-90390-51	Kit di ricambio con 4 ganci di fissaggio e 4 tappi di chiusura grigi (2+2) per Profilo 39 Recessed Spare parts kit with 4 fixing clips and 4 gray closing caps (2+2) for Profile 39 Recessed
84-90400-51	Kit di ricambio con 4 ganci di fissaggio e 4 tappi di chiusura grigi (2+2) per Profilo 40 Corner Spare parts kit with 4 fixing clips and 4 gray closing caps (2+2) for Profile 40 Corner



Stripled

Stripled professionali con alimentazione 24VDC semplici da installare su profili dissipanti in alluminio. Sono fornite in bobine da 5 metri e sono complete di biadesivo 3M. Possono essere sezionate a interassi prefissati con un cutter. Ideali per illuminare ambienti, creando un effetto luminoso decorativo. L'elevato numero di LED per metro dimmerabili consente un'ottima e uniforme distribuzione della luce.

Temperatura di stoccaggio: 0°C + 60°C
Temperatura di utilizzo: -25°C + 60°C

Professional **LED stripes** with 24VDC voltage easy to be installed on dissipating aluminium profiles. The **LED stripes** are supplied in 5 meters coils and include 3M double-sided tape. They can be cut at predetermined interaxal spacings with a cutter. Ideal to enlighten spaces, with a decorative luminous effect. The great number of dimmable LEDs per meter allows an excellent and uniform light distribution.

Storing temperature: 0°C + 60°C
Operating temperature: -25°C + 60°C

STRIPLED 24VDC



Codice Code	Watt/mt	Lumen/mt	LED/mt	Colour T (K)	CRI	Fascio Beam
93-9WB-0715F	9,6	715	120	3000	85	120°
93-9WA-0715F	9,6	715	120	4000	85	120°

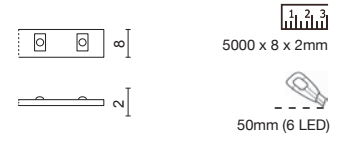

CE IP33 A+ A+ A

STRIPLED 24VDC



93-9WB-1330F	14,4	1330	120	3000	85	120°
93-9WA-1330F	14,4	1330	120	4000	85	120°

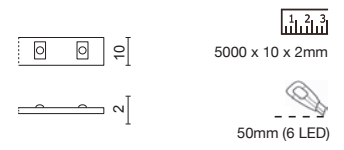

CE IP33 A+ A+ A

STRIPLED 24VDC



93-9WB-1390F	19,2	1390	240	3000	85	120°
93-9WA-1390F	19,2	1390	240	4000	85	120°

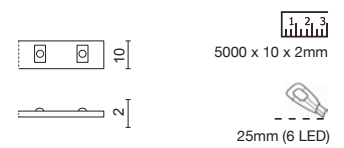

CE IP33 A+ A+ A

5000 mm



Driver da ordinare separatamente
Driver should be ordered separately



91-90032

150 W

Tensione costante 24VDC
24VDC constant voltage





Bender Light

Striscia luminosa 24Vdc flessibile inguainata ideale per illuminare ambienti interni ed esterni. Resistente al calore, ai raggi UV, solventi e salsedine, può essere sezionata a interassi prefissati ed è fornita in bobine da 10 metri. Semplice da installare, consente di realizzare scenografie luminose grazie alla sua flessibilità, senza effetto puntinato.

Ideale per molteplici installazioni sia in esterni sia in interni, oltre all'illuminazione di insegne e a effetti scenografici.

Temperatura di stoccaggio: -20°C + 45°C
Temperatura di utilizzo: 0°C + 45°C

Flexible sheathed LED **strip light** 24Vdc ideal for outdoor and indoor lighting. It is flame, UV, solvent and seawater resistant.

It can be cut at predetermined interaxial spacings and it is supplied in 10 meters coil. Easy to be installed, it enlightens without dots effect thanks to its flexibility. Suitable for many installations including outdoor, indoor, signage and for decorative effects.

Storing temperature: -20°C + 45°C
Operating temperature: 0°C + 45°C

BENDER LIGHT



Codice Code	Watt/mt	Lumen/mt	LED/mt	Colour T (K)	CRI	Fascio Beam
93-WB15-0320-10	12	320	72	3000		160°
93-WA15-0320-10	12	320	72	4000		160°

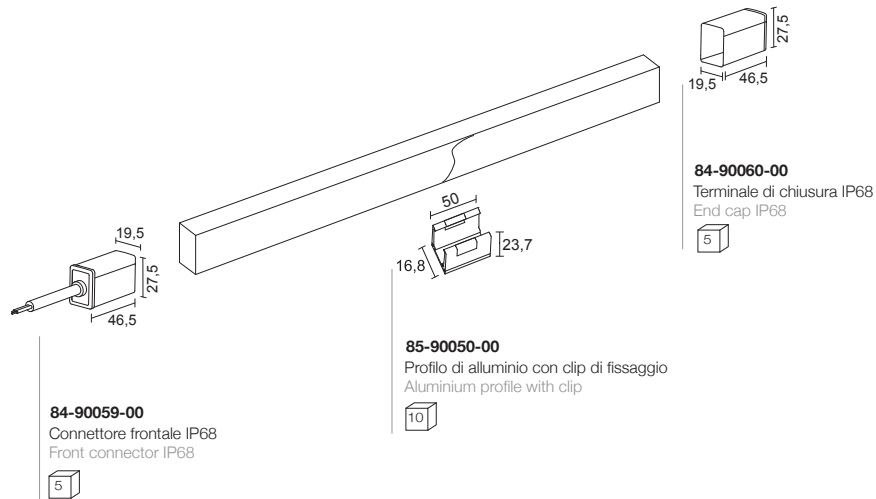
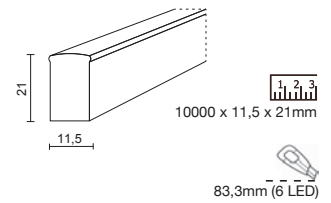

Minima piegatura
Minimum bend diameter

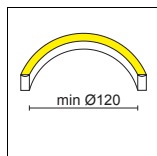

Applicazioni
Applications

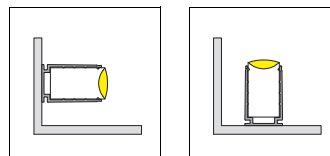

Driver da ordinare separatamente
Driver should be ordered separately



91-90032

150 W

Tensione costante 24VDC
24VDC constant voltage







Dino
p.229



Dedo 100
p.231



Lito 230
p.236



Lito
p.237



Lito base
p.237



Maxilito
p.241



Maxilito Power
p.241



Proiettori da esterno

EXTERIOR SPOTLIGHTS

Dino

Studio Tecnico Ivela

Dino è un mini spot orientabile per luce d'accento, ideale per valorizzare e creare atmosfere suggestive in spazi verdi e giardini.

È applicabile a pavimento, a parete o nel terreno utilizzando l'apposito picchetto in termoplastico. Elevato grado di protezione IP67/44.

Dino viene fornito con cavo H05RN-F e spina Shuko, equipaggiato con LED COB a tensione di rete, dalla lunga durata e ridotti consumi. Non necessita di driver. Disponibili versioni con riflettore prismatico a superficie sfaccettata specchiante per fasci luminosi di 15° e 36°.

Materiali:

- Corpo in termoplastico ad alta resistenza stampato a iniezione
- Schermo di protezione in nylon trasparente infrangibile, a elevato grado di stabilità UV
- Riflettore sfaccettato in termoplastico metallizzato (dove previsto)
- Picchetto in termoplastico
- Pressacavo M12,5 in ottone nichelato, completo di 2 mt. di cavo H05RN-F e spina Shuko
- Guarnizioni in EPDM

Dino is an adjustable mini spotlight for accent lighting ideal to make the most of gardens and green areas, creating evocative atmospheres.

Ideal for applications on the floor, on the wall or in the ground with a spike. High protection rating IP67/44. Including a H05RN-F cable and a Shuko plug, **Dino** is supplied with mains voltage COB LED, which combines energy saving and a long service life. LED driver is not needed.

Versions with prismatic reflectors with a faceted mirror surface are also available for 15° and 36° light beams.

Materials:

- Body in injection-moulded high resistant thermoplastic
- Shockproof safety screen in clear nylon, with a high UV stability degree
- Reflector in faceted mirror-metallized thermoplastic (where applicable)
- Thermoplastic ground-spike
- Cable-gland M12,5 in nickel-plated brass, complete with 2 mt. cable H05RN-F and Shuko plug
- EPDM gaskets combines energy saving and a long service life.



DINO



Codice Code	Colore Colour	LED Lumen	Product Lumen	Watt	Colour T (K)	CRI	Fascio Beam
173S03130	Nero/Black	240	-	3,6	3000	80	110°
173S03120	Grigio/Grey	240	-	3,6	3000	80	110°

Con LED a tensione di rete
With supply voltage LED

230V – 50/60Hz

CE IP67/44 IK08

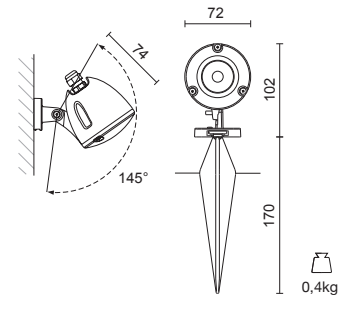

DINO



Con riflettore
With reflector

173RS3130	Nero/Black	240	-	3,6	3000	80	15°
173RS3120	Grigio/Grey	240	-	3,6	3000	80	15°
173RM3130	Nero/Black	240	-	3,6	3000	80	36°
173RM3120	Grigio/Grey	240	-	3,6	3000	80	36°

Con LED a tensione di rete
With supply voltage LED

230V – 50/60Hz

CE IP67/44 IK08

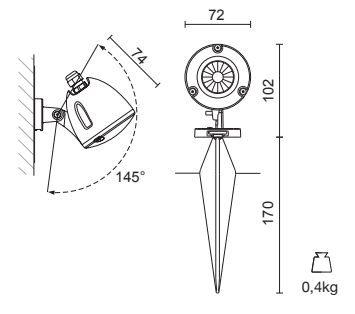

84108

Connettore stagno
Rated cable connector





Dedo 100

Studio Tecnico Ivela

Proiettore orientabile con LED COB per applicazioni a terreno con picchetto, a pavimento o a parete. **Dedo 100** è adatto per illuminazione d'accento in molteplici contesti residenziali o commerciali quali giardini, condomini, centri residenziali, strutture polivalenti o per evidenziare particolari architettonici. Il morsetto a innesto rapido facilita il collegamento elettrico. Ottiche professionali intercambiabili per fasci luminosi differenti sono disponibili come accessori. Apparecchio in classe II (doppio isolamento), non necessita di messa a terra. Elevato grado di protezione IP66.

Materiali:

- Corpo e anello frontale in termoplastico ad alta resistenza, stampato a iniezione, rinforzato F.V.
- Ottiche professionali in termoplastico metallizzato a specchio
- Picchetto in termoplastico
- Vetro di protezione temprato (4 mm), resistente agli shock termici e agli urti
- Guarnizioni siliciche
- Pressacavo in ottone nichelato M12x1,5 completo di 2 mt. di cavo H05RN-F e spina

Adjustable COB LED spotlight for applications in the ground with a spike, or to be mounted on the floor or on the wall. **Dedo 100** is suitable for accent lighting in many residential or commercial applications such as gardens, apartment buildings, residential centres, and multi-purpose facilities or to emphasize architectural details. The quick plug terminal block allows an easy electrical connection. Professional optic devices for different light beams are available as accessories. Fitting in class II (double insulation), it does not require earthing. High protection rating IP66.

Materials:

- Housing and front ring in injection moulded high resistant thermoplastic, reinforced with fiber glass
- Professional optics in mirror metallized thermoplastic material
- Thermoplastic ground spike
- Tempered safety glass (4mm), thermal resistant and shockproof
- Silicone gaskets
- Nickel plated brass cable-gland M12x1,5 complete with 2 mt. cable H05RN-F and plug

Modello di design depositato / Registered design model

DEDO 100

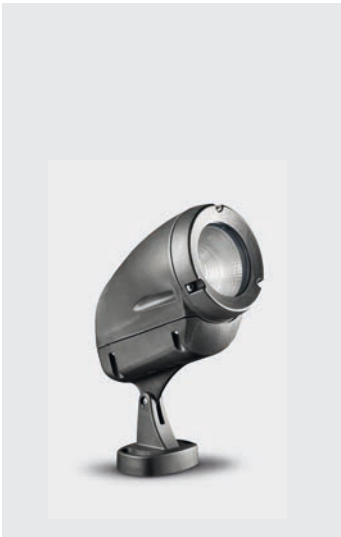

Codice Code	Colore Colour	LED Lumen	Product Lumen	Watt	Colour T (K)	CRI	Fascio Beam
111801	Nero/Black	1700	-	12	3000	85	30°
111802	Grigio/Grey	1700	-	12	3000	85	30°

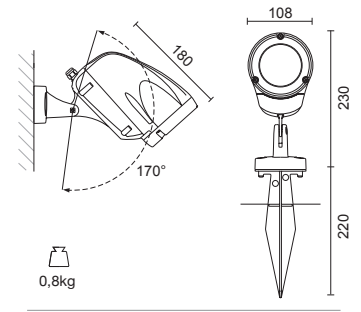

220/240V - 50/60Hz

Accessori ottici intercambiabili
Replaceable optical accessories



28-3140-51

Ottica professionale S
Professional optic device S

12W



28-3142-51

Ottica professionale M
Professional optic device M



28-3138-51

Ottica professionale W
Professional optic device W



28-3141-31

Ottica professionale XW
Professional optic device XW



84108

Connettore stagno
Rated cable connector



160821

Bobina di cavo di alimentazione H05RN-F 2x1mm², L 10mt
10mt supply cable coil H05RN-F 2x1mm²





Lito

design: **Enrico Davide Bona e Elisa Nobile**

Gli innovativi proiettori per esterni **Lito**, unici nel loro genere, sono in grado di fornire un'elevata potenza di luce, in abbinamento a dimensioni compatte e a un ridotto impatto visivo. **Lito** applicano gli ultimi sviluppi della tecnologia LED COB: dimensioni compatte e facilità di utilizzo li rendono discreti e ideali dove sia richiesta una luce d'accento ecologica anche in zone di passaggio. **Lito** possono essere applicati a parete oppure, tramite l'apposito picchetto in materiale termoplastico, nel terreno.

E' disponibile una versione con LED a tensione di rete regolabile sulla fase. **Lito 230**, caratterizzato da un design sobrio ed essenziale, è ideale per creare scenografie luminose sia in spazi verdi che su facciate, anche grazie alle ottiche professionali facilmente intercambiabili.

The exterior spotlights **Lito** are a one-of-a-kind innovative exterior spotlights, able to provide high luminous output, in combination with a compact size and a low visual impact. **Lito** make use of the last developments of the LED COB technology: compact dimensions and user friendly application make them unobtrusive and ideal wherever an ecological accent lighting is needed also in passageways.

Lito can be installed on the wall or in the ground through the thermoplastic spike provided for the purpose. It is available a version with supply voltage LED dimmable on the mains. **Lito 230**, featuring a sober and essential design, is ideal to set up light scenes both in gardens and on facades, also thanks to the easily interchangeable professional optics.

Modello di design depositato / Registered design model



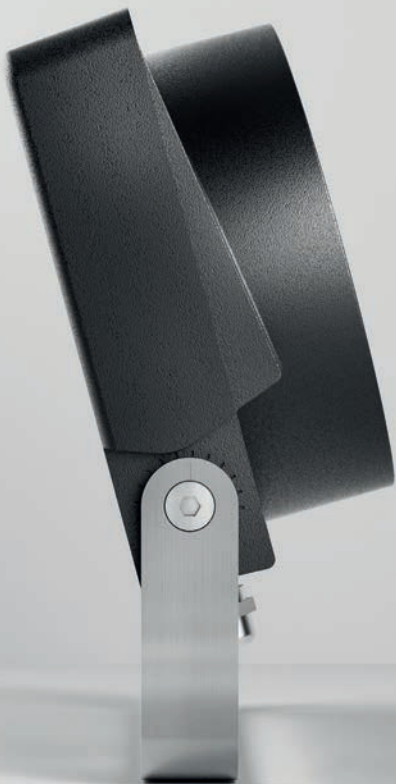

Materiali:

- Corpo in pressofusione di alluminio, con speciale pretrattamento antiossidante e verniciatura poliesteri stabilizzata ai raggi UV
- Ottiche professionali in termoplastico metallizzato a specchio
- Schermo in materiale termoplastico trasparente ad alta resistenza, UV protetto (dove previsto)
- Mascherina in termoplastico testurizzato (dove previsto)
- Picchetto in termoplastico
- Staffa di fissaggio e viti in acciaio inox
- Pressacavo M12,5 in ottone nichelato, completo di 2 mt di cavo H05RN-F
- Guarnizioni siliconiche

Materials:

- Body in die-cast aluminium with a special anti-oxidizing pretreatment. The polyester painting is stabilized to UV rays
- Professional optics in mirror-metallized thermoplastic material
- Screen in UV resistant, clear thermoplastic material (where applicable)
- Textured thermoplastic cover (where applicable)
- Thermoplastic ground-spike
- Bracket and screws in stainless steel
- M12,5 cable-gland in nickel-plated brass, complete with 2mt H05RN-F cable
- Silicone gaskets



LITO 230



Codice Code	Colore Colour	LED Lumen	Product Lumen	Watt	Colour T (K)	CRI	Fascio Beam
11430030	Nero/Black	2000	1780	19	3000	80	38°
11430085	Metal/Silver	2000	1780	19	3000	80	38°
11430067*	Ruggine/Rust	2000	1780	19	3000	80	38°

* Su richiesta
* On demand

Con LED a tensione di rete regolabile sulla fase
With supply voltage LED dimmable on the mains

220/240V - 50/60Hz

CE IP66 IK10

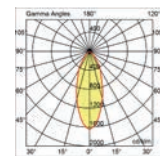
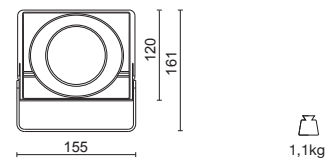
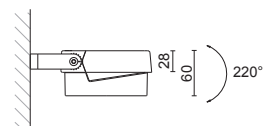

38°

Accessori ottici intercambiabili Replaceable optical accessories



28-3140-51

Ottica professionale S
Professional optic device S

19W



28-3142-51

Ottica professionale M
Professional optic device M



28-3138-51

Ottica professionale W
Professional optic device W



28-3141-31

Ottica professionale XW
Professional optic device XW



28-4019-30

Frangiluce alveolare
Honeycomb



84108

Connettore stagno
Rated cable connector



LITO

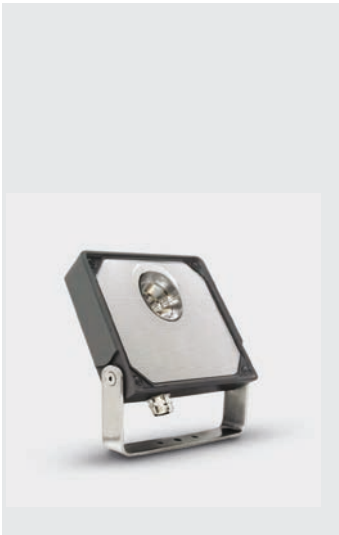

Codice Code	Colore Colour	LED Lumen	Product Lumen	Watt	Colour T (K)	CRI	Fascio Beam
11200030	Nero/Black	1800	1486	12	3000	85	30°
11200085	Metal/Silver	1800	1486	12	3000	85	30°

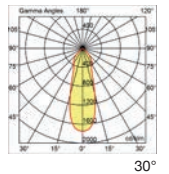
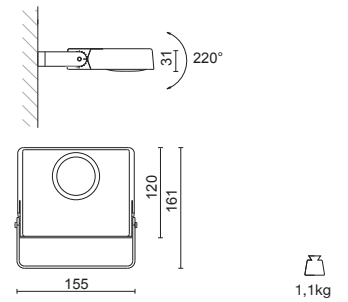

220/240V – 50/60Hz



LITO BASE



11220230	Nero/Black	3350	-	26	3000	85	38°
11220285	Metal/Silver	3350	-	26	3000	85	38°

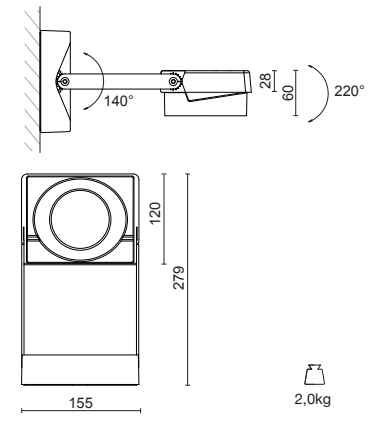

220/240V – 50/60Hz



Accessori ottici intercambiabili per Lito Base
Replaceable optical accessories for Lito Base



28-3140-51

Ottica professionale S
Professional optical device S

26W



28-3142-51

Ottica professionale M
Professional optical device M



28-3138-51

Ottica professionale W
Professional optical device W



28-3141-31

Ottica professionale XW
Professional optical device XW



28-4019-30

Frangiluce alveolare
Honeycomb



84108

Connettore stagno
Rated cable connector





Maxilito & Maxilito Power

design: **Enrico Davide Bona e Elisa Nobile**

Proiettori orientabili per esterni progettati e realizzati appositamente per ospitare LED COB di nuova generazione, **Maxilito** e **Maxilito Power** valorizzano le superfici verticali, anche in interni, di edifici pubblici e privati, oltre a vetrine e giardini.

Facilmente installabili, possono essere applicati sia a parete sia a terra, e rispondono ai requisiti delle più diverse esigenze di progettazione illuminotecnica.

Il loro profilo compatto, a ridotto impatto visivo rispetto ai proiettori tradizionali, è ideale per l'applicazione in ambienti dove sia richiesta una luce potente, ecologica e d'effetto.

Il frontale di chiusura, in pressofusione di alluminio per aumentare la superficie dissipante, può essere facilmente rimosso per consentire la sostituzione dell'ottica e generare fasci luminosi di ampiezza differente. Il corpo degli apparecchi è protetto da uno speciale pretrattamento antiossidante per un'elevata resistenza agli agenti atmosferici.

Maxilito è disponibile anche con temperatura di colore 4000K.

Maxilito and **Maxilito Power** are spotlights for outdoor lighting, specifically designed to be equipped with a new generation of COB LEDs. They are ideal to place the right emphasis on both outdoor and indoor areas of public and private buildings, gardens and shop windows. They are easy to install both on the wall or on the ground for a more flexible response to the needs of lighting design.

Their compact and sober design, reducing visual impact in comparison to traditional spotlights, is perfect for applications where a powerful and ecological accent lighting is needed.

The front closing element, in die-cast aluminium to increase the heat dissipating surface, can be easily removed to replace the optic for different beam angles. The body of the fittings is protected by a special antioxidizing treatment for a higher resistance against aggressive agents.

Maxilito is available also in 4000K colour temperature.



**Materiali:**

- Corpo e frontale di chiusura in pressofusione di alluminio, verniciato poliestere, con pretrattamento antiossidante
- Ottiche professionali in termoplastico metallizzato a specchio
- Vetro di protezione temprato e molato (8mm), resistente agli shock termici
- Staffa di fissaggio e viti in acciaio inox
- Pressacavo m 12,5 in ottone nichelato e 2 mt di cavo H05RN-F
- Guarnizioni silconiche

Materials:

- Body and front part in die-cast aluminium, polyester painted, with an anti-oxidizing pre-treatment
- Professional optics in mirror-metallized thermoplastic material
- Tempered safety glass (8mm), thermal shocks resistant
- Bracket and screws in stainless steel
- Cable-gland in nickel-plated brass provided with 2 mt H05RN-F cable
- Silicone gaskets

MAXILITO



Codice Code	Colore Colour	LED Lumen	Product Lumen	Watt	Colour T (K)	CRI	Fascio Beam
11461130	Nero/Black	6800	6136	51	3000	85	30°
11461185	Metal/Silver	6800	6136	51	3000	85	30°

Su richiesta
On demand

1146A1130	Nero/Black	4900	4037	39	3000	85	30°
1146A1185	Metal/Silver	4900	4037	39	3000	85	30°
1145A1130	Nero/Black	5000	4119	39	4000	85	30°
1145A1185	Metal/Silver	5000	4119	39	4000	85	30°

220/240V – 50/60Hz

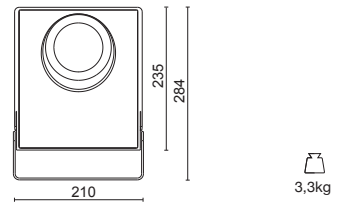
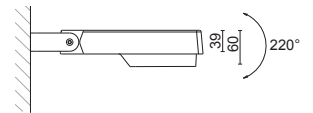

MAXILITO POWER



10910130	Nero/Black	9900	8855	75	3000	85	40°
10910185	Metal/Silver	9900	8855	75	3000	85	40°

220/240V – 50/60Hz

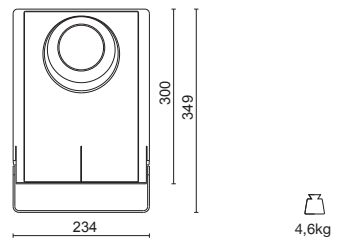
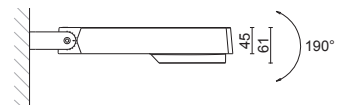

Accessori ottici
intercambiabili
Replaceable optical
accessories



28-3140-51

Ottica professionale S
Professional optic device S

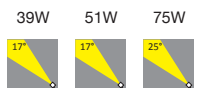

28-3142-51

Ottica professionale M
Professional optic device M

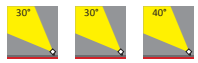

28-3138-51

Ottica professionale W
Professional optic device W

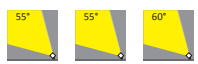

28-3141-31

Ottica professionale XW
Professional optic device XW

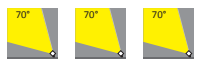

28-4019-30

Frangiluce alveolare
Honeycomb



84108

Connettore stagno
Rated cable connector









Balti 80
p.251



Balti 150
p.252



Balti 220
p.253



Balti 260
p.254



Balti 320
p.255



Bidi Applique
p.261



PN 110Q Applique
p.263

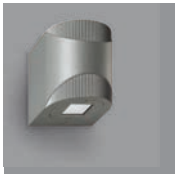

Miniten
p.265



Luci da facciata

FAÇADE LIGHTS



Balti

design: **Enrico Davide Bona e Elisa Nobile**

Balti, interamente progettata per sorgenti luminose LED COB di ultima generazione, è una serie di applique per esterno a luce diretta o indiretta.

Il disegno del corpo, fortemente innovativo, dalla semplicità geometrica e dai tratti sinuosi, è concepito per rispondere alle esigenze di dissipazione passiva del calore richieste dall'applicazione di LED COB, abbinata a dimensioni di prodotto minimizzate. Disponibili versioni in cinque differenti dimensioni a emissione mono o bidirezionale.

Il profilo delle applique risulta essere estremamente aderente alla parete, ideale per spazi residenziali / hospitality quali zone di passaggio, atri o terrazzi.

La serie è caratterizzata da alti gradi di protezione IP65/66 e da uno speciale pretrattamento antiossidante delle superfici.

Balti is a range of outdoor wall luminaires for direct or indirect lighting, designed for COB LED luminous sources of the last generation.

The body shows an innovative design, relying on a simple geometry and on sinuous lines. It is conceived to optimize the performance of the COB LED used, meeting the requirements of passive heat dissipation, combined with minimized product dimensions.

The range includes five different sizes, versions with mono or bi-directional light emission are available.

The fittings reduce to a minimum the protrusion from the wall: they are ideal for applications in residential and hospitality areas such as passageways, corridors and terraces.

The series features a high protection rating IP65/66, and a special anti-oxidising pretreatment of the surface.

Modelli di design depositato / Registered design models

La gamma **Balti** comprende cinque diverse dimensioni che offrono svariate possibilità di illuminazione in grado di garantire un'alta qualità della luce (warm white) ed eccellenti prestazioni illuminotecniche.

La diffusione della luce è sottolineata da una leggera increspatura nel corpo di alluminio, che consente a **Balti** di collocarsi con eleganza anche in interni.

Materiali

- Corpo in pressofusione di alluminio verniciato in poliesteri con speciale pretrattamento antiossidante per un'elevata resistenza agli agenti atmosferici
- Schermo di chiusura in policarbonato trasparente (per Balti 80)
- Vetro di chiusura temprato (per le altre versioni)

The fittings of the range **Balti** are available in five different dimensions, that offer a wide spectrum of lighting options, with a high luminous quality (war white) and excellent lighting performance.

The light diffusion is underlined by a slight rippling in the aluminium body, allowing to install **Balti** with elegance also in indoor applications.

Materials:

- Body in die-cast aluminium, polyester painted with a special anti-oxidising treatment, for a high resistance against severe environment
- Clear polycarbonate closing screen (for Balti 80)
- Tempered closing glass (for the other versions)

DISTRIBUZIONE LUMINOSA LIGHT DISTRIBUTION

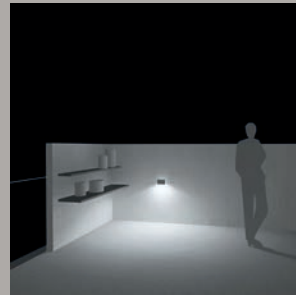

Balti 80

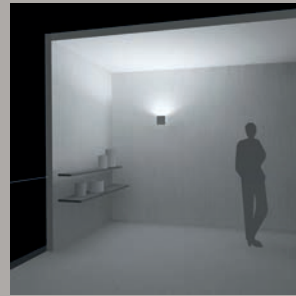
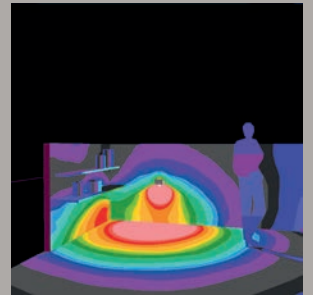

Balti 150

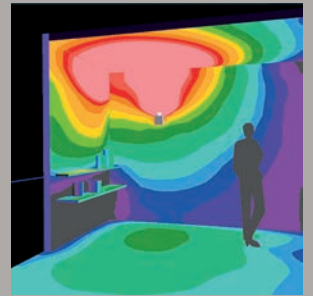

Balti 220

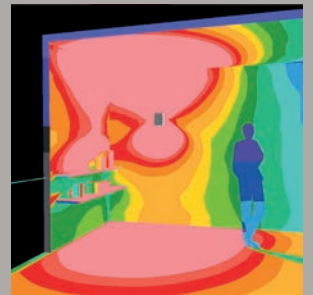

Balti 260

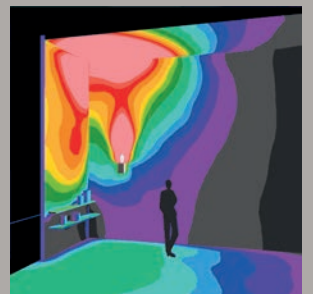

Balti 320

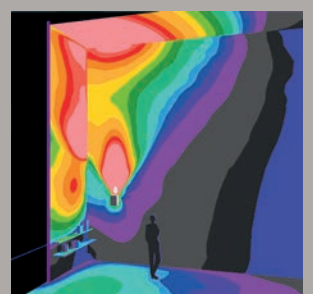



Il fascio luminoso della serie **Balti** è stato studiato con un'apertura specifica che permette di illuminare ampiamente la parete e, a seconda dell'applicazione, il soffitto o il pavimento senza abbagliare, grazie al particolare angolo di inclinazione del LED all'interno dell'apparecchio.

Balti 260 e **Balti 320** sono accessoriabili con ottiche intercambiabili per ottenere fasci di differenti aperture e gestire, in maniera più dinamica, la regia luminosa.

Balti has been designed with a specific beam to ensure a wide lighting of the wall or of the ceiling and of the floor without glare, thanks to the specific angle of inclination of the LED within the fittings.

Balti 260 and **Balti 320** can be supplied with interchangeable optics in order to obtain different light beams and to manage the lighting project in a more dynamic way.

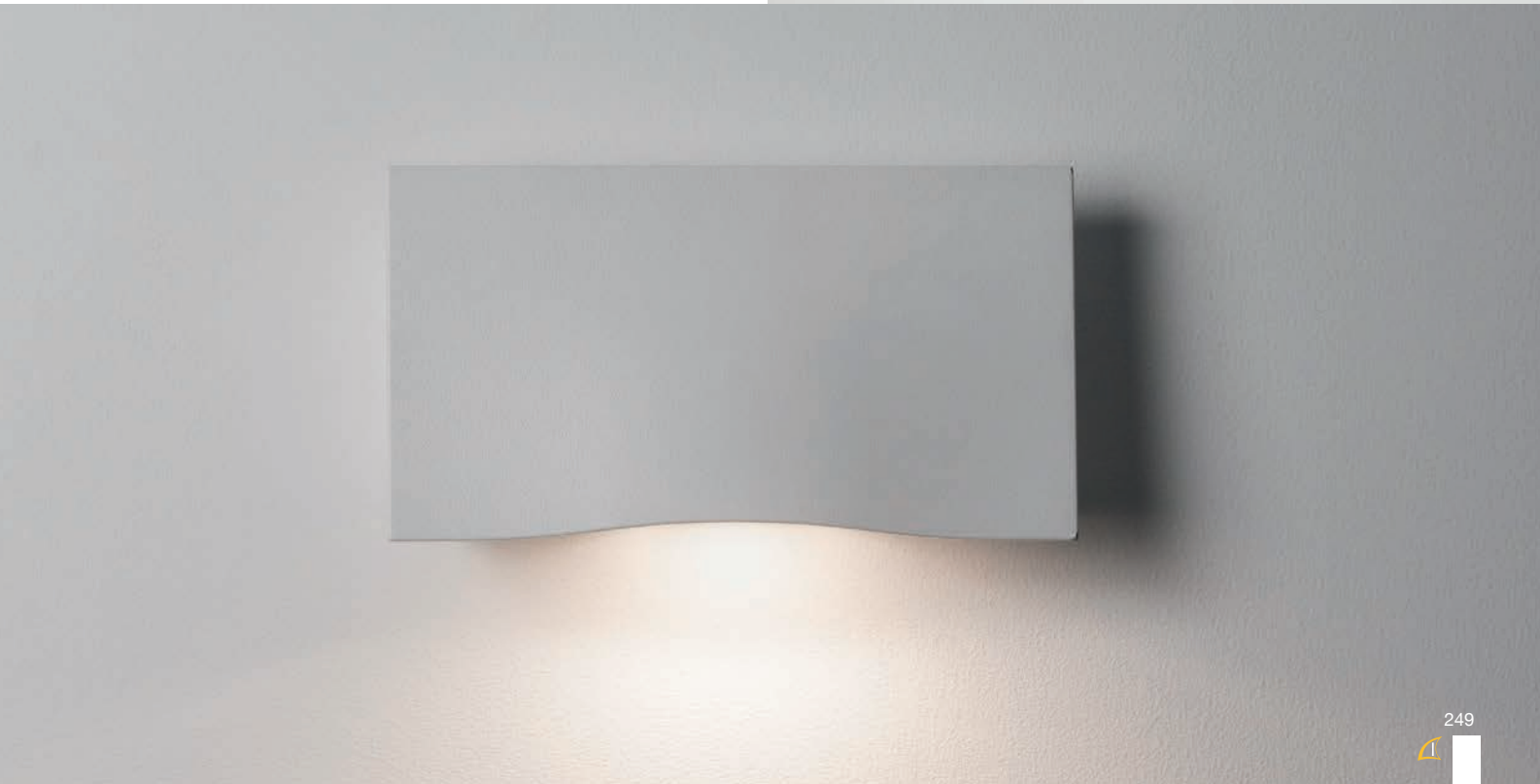
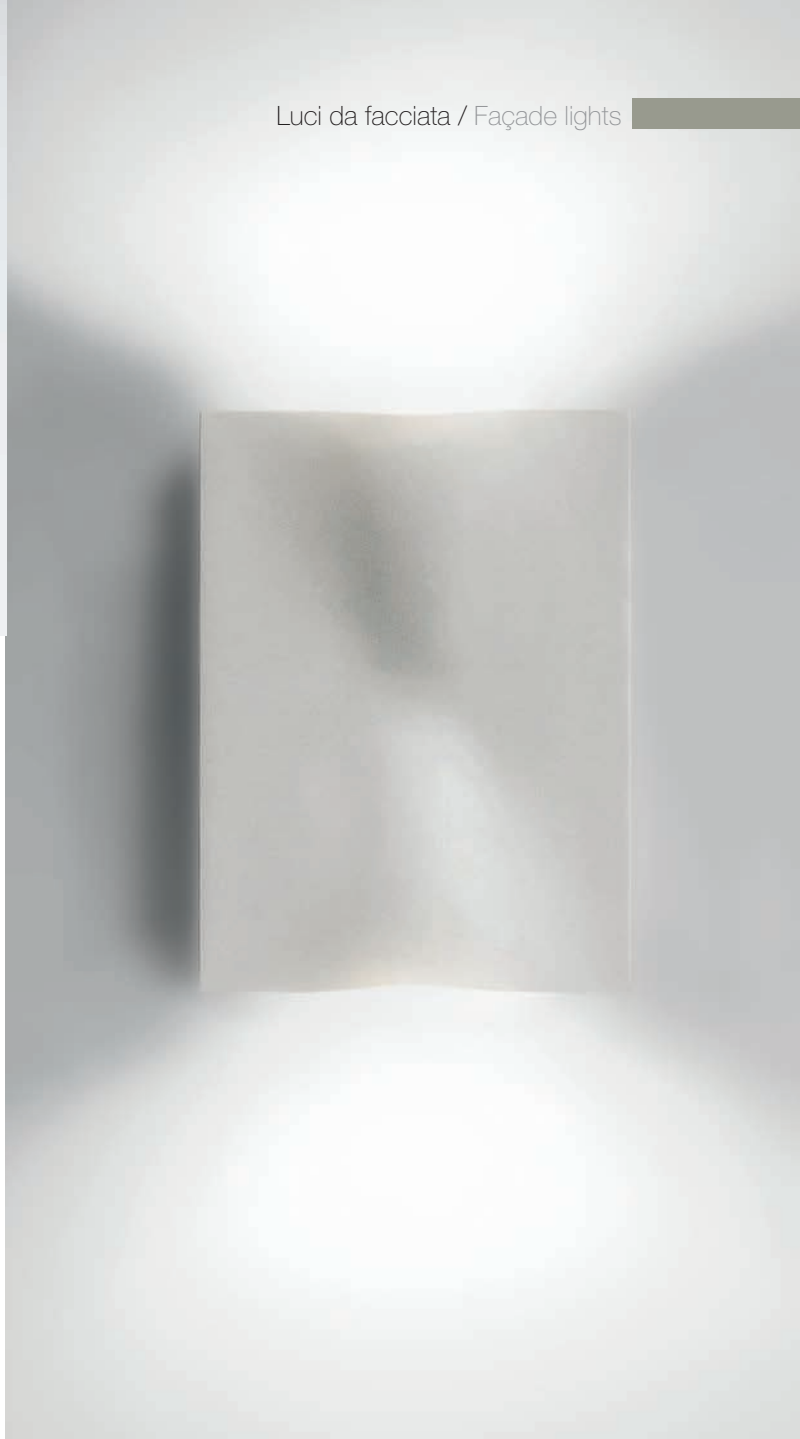



BALTI 80



Codice Code	Colore Colour	LED Lumen	Product Lumen	Watt	Colour T (K)	CRI	Fascio Beam
Monodirezionale Single-light							
119304	Bianco/White	850	646	6,5	3000	85	110°
119303	Metal/Silver	850	646	6,5	3000	85	110°

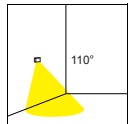
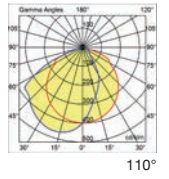
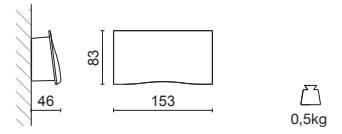

220/240V - 50/60Hz



BALTI 150



Codice Code	Colore Colour	LED Lumen	Product Lumen	Watt	Colour T (K)	CRI	Fascio Beam
Monodirezionale Single-light							
118504	Bianco/White	1800	1348	12	3000	85	110°
118503	Metal/Silver	1800	1348	12	3000	85	110°
118304	Bianco/White	3400	2374	26	3000	85	110°
118303	Metal/Silver	3400	2374	26	3000	85	110°

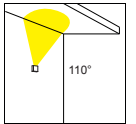
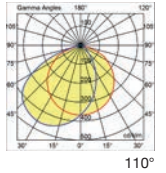
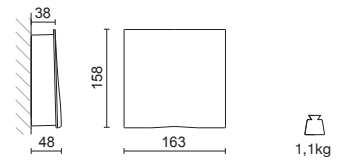

220/240V - 50/60Hz



BALTI 220

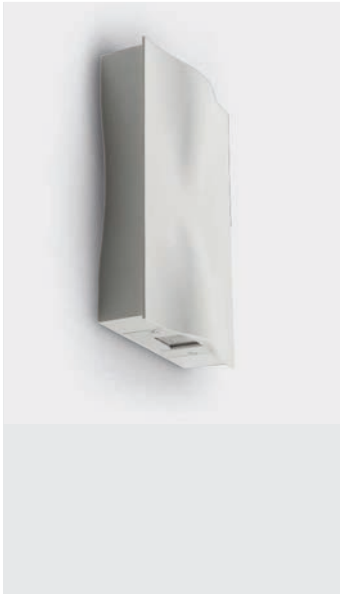

Codice Code	Colore Colour	LED Lumen	Product Lumen	Watt	Colour T (K)	CRI	Fascio Beam
Bidirezionale Bi-directional							
119804	Bianco/White	2x3400	2x2798	2x26	3000	85	100°/100°
119803	Metal/Silver	2x3400	2x2798	2x26	3000	85	100°/100°
Bidirezionale (su richiesta) Bi-directional (on demand)							
119704	Bianco/White	2500+1200	2058+988	18+12,5	3000	85	44°/100°
119703	Metal/Silver	2500+1200	2058+988	18+12,5	3000	85	44°/100°
Monodirezionale Single-light							
119604	Bianco/White	1x5200	1x4005	37	3000	85	100°
119603	Metal/Silver	1x5200	1x4005	37	3000	85	100°

220/240V - 50/60Hz

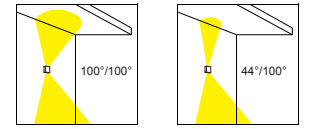
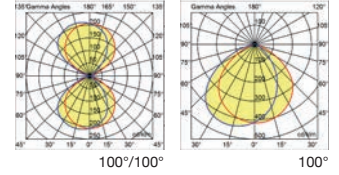
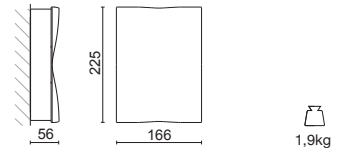

BALTI 260



Codice Code	Colore Colour	LED Lumen	Product Lumen	Watt	Colour T (K)	CRI	Fascio Beam
Bidirezionale Bi-directional							
1081RW04	Bianco/White	2x2400	-	2x18	3000	85	30°/30°
1081RW03	Metal/Silver	2x2400	-	2x18	3000	85	30°/30°
Monodirezionale Single-light							
1084RW04	Bianco/White	1x3200	-	1x26	3000	85	30°
1084RW03	Metal/Silver	1x3200	-	1x26	3000	85	30°

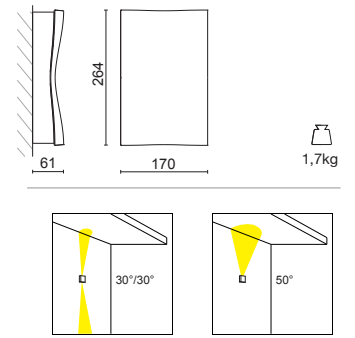

220/240V - 50/60Hz

Accessori ottici intercambiabili

Replaceable optical accessories



28-3869-51

Ottica professionale M
Professional optical device M

18W 26W



28-3868-51

Ottica professionale W
Professional optical device W

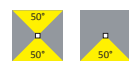

28-3868-31

Ottica professionale XW
Professional optical device XW

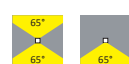

BALTI 320



Codice Code	Colore Colour	LED Lumen	Product Lumen	Watt	Colour T (K)	CRI	Fascio Beam
Bidirezionale Bi-directional							
1073RW04	Bianco/White	2x4900	2X4361	2x38	3000	85	30°/30°
1073RW03	Metal/Silver	2x4900	2X4361	2x38	3000	85	30°/30°
Monodirezionale Single-light							
1071RW04	Bianco/White	1x9900	1x8865	1x75	3000	85	40°
1071RW03	Metal/Silver	1x9900	1x8865	1x75	3000	85	40°

220/240V - 50/60Hz

CE IP66 IK09

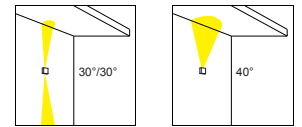
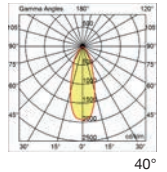
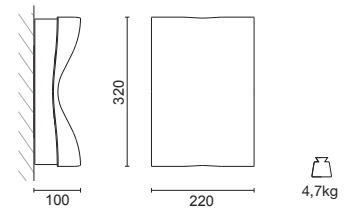

Accessori ottici intercambiabili
Replaceable optical accessories



28-3140-51

Ottica professionale S
Professional optic device S

38W 75W



28-3142-51

Ottica professionale M
Professional optic device M

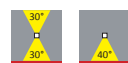

28-3138-51

Ottica professionale W
Professional optic device W

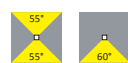

28-3141-31

Ottica professionale XW
Professional optic device XW

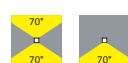

28-4019-30

Frangiluce alveolare
Honeycomb







Bidi Applique

design: **Enrico Davide Bona e Elisa Nobile**

Bidi Applique è un apparecchio a parete per esterni innovativo e versatile dal design minimale, in grado di offrire elevate prestazioni luminose, ideale per l'illuminazione di facciate, superfici verticali o porticati. E' possibile scegliere tra la versione monodirezionale con ottica simmetrica e fascio 44° oppure la versione bidirezionale con ottica asimmetrica e luce diffusa. Questa applique è miniaturizzata grazie all'impiego di LED COB di ultima generazione: ne risulta una figura parallelepipedica estremamente piatta e caratterizzata da una cornice che inquadra il diffusore, creando un gioco di spessori. Il corpo è in pressofusione di alluminio verniciato con uno speciale pretrattamento antiossidante ed è disponibile nei colori bianco o ruggine.

Bidi Applique is an innovative and versatile exterior wall light, able to stand out thanks to its minimal design and the high-lighting performance, ideal to be mounted on façades, vertical surfaces or arcades.

It is possible to choose between the single light version with symmetric optic and 44° beam or the bidirectional one with asymmetric optic and diffused light.

This wall light is miniaturized thanks to the use of the COB LED of last generation: it results in an extremely flat parallelepiped shape featuring a frame which highlights the diffuser with an innovative visual effect.

The body is in die-cast aluminium painted in white or rust with a special antioxidising pre-treatment.

Modello di design depositato / Registered design model



Applique bidirezionale
con doppio fascio asimmetrico
ampio per illuminare la parete

Bidirectional wall-light with
double wide asymmetric beam
for wall lighting

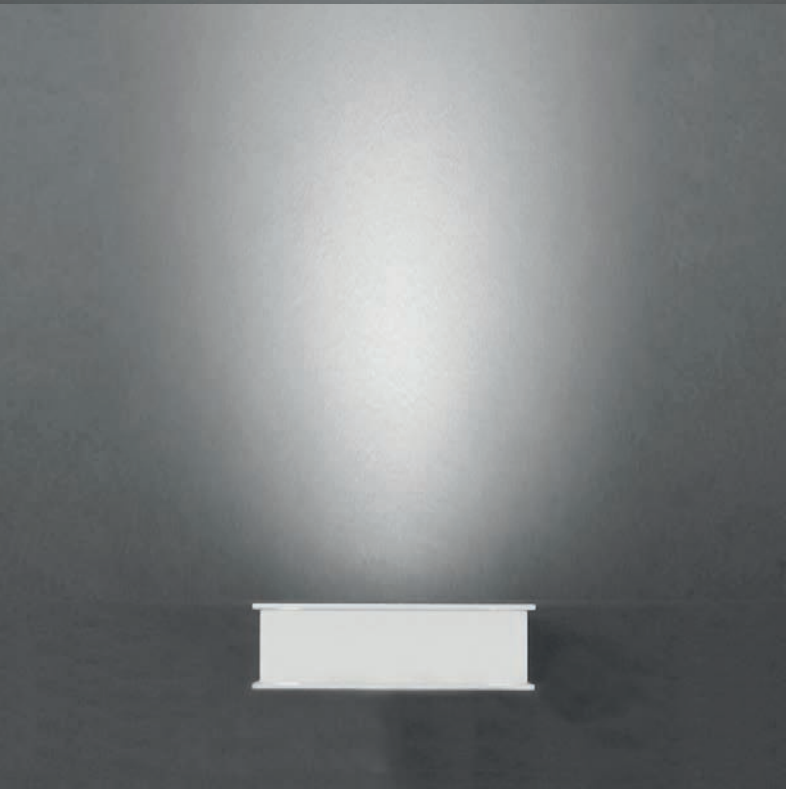
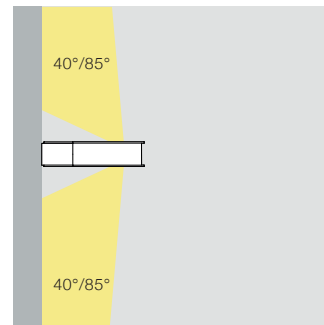

Applique monodirezionale
con fascio simmetrico da 44°
per illuminazione indiretta

Monodirectional wall-light
with 44°symmetric beam for
indirect lighting

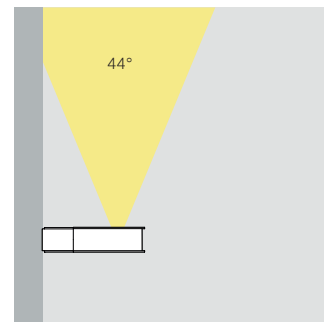

Materiali:

- Corpo e base per attacco a parete in pressofusione di alluminio, verniciato poliesteri, con uno speciale trattamento antiossidante
- Schermo diffusore in policarbonato trasparente Viteria in acciaio inox

Materials:

- Body and base for wall mounting in die-cast aluminium polyester painted with a special antioxidizing treatment
- Diffuser in clear polycarbonate
- Stainless steel screws



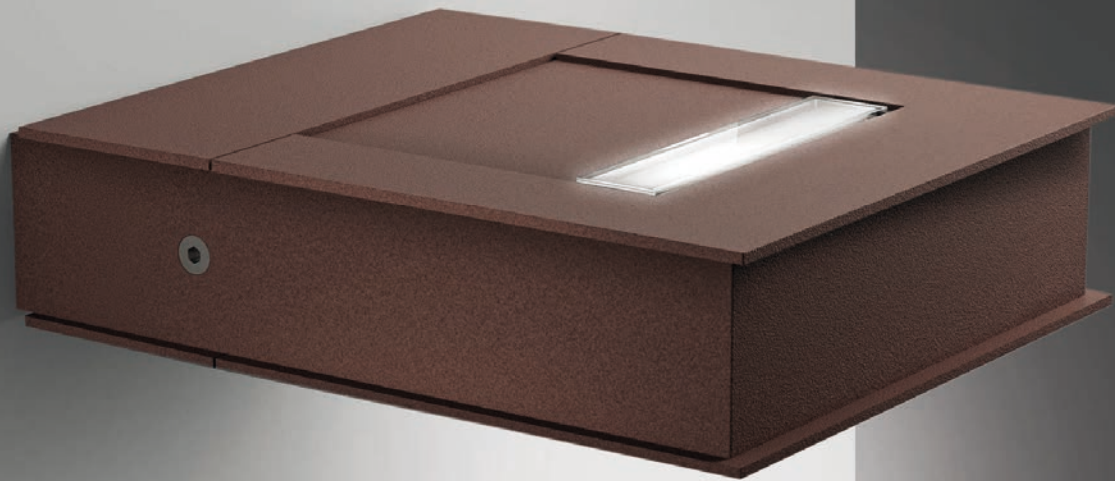



BIDI APPLIQUE



Codice Code	Colore Colour	LED Lumen	Product Lumen	Watt	Colour T (K)	CRI	Fascio Beam
-------------	---------------	-----------	---------------	------	--------------	-----	-------------

Testa illuminante monodirezionale con ottica simmetrica
Monodirectional lighting head with symmetric optics

190704	Bianco/White	1x1800	1x1271	1x12	3000	85	44°
190767	Ruggine/Rust	1x1800	1x1271	1x12	3000	85	44°

Testa illuminante bidirezionale con ottiche asimmetriche
Bi-directional lighting head with asymmetric optics

190604	Bianco/White	2x1800	2x1271	2x12	3000	85	$\alpha 40^\circ / \beta 85^\circ$
190667	Ruggine/Rust	2x1800	2x1271	2x12	3000	85	$\alpha 40^\circ / \beta 85^\circ$

Base per attacco a parete
Base for wall mounting

1635004	Bianco/White
1635067	Ruggine/Rust

Le teste illuminanti devono essere ordinate separatamente
Lighting heads should be ordered separately

220/240V - 50/60Hz

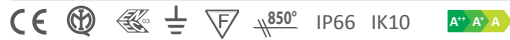

1907/1906

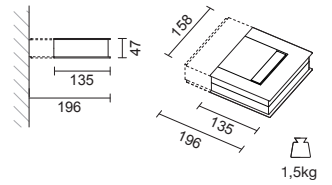

1635

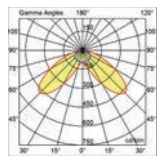
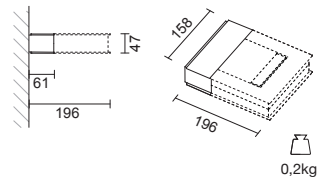

$\alpha 40^\circ / \beta 85^\circ$

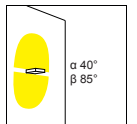
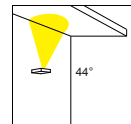



PN110 Q Applique

design: **Enrico Davide Bona e Elisa Nobile**

PN110 Q Applique è l'evoluzione della gamma delle plafoniere a LED per esterni della famiglia PN. La sofisticata tecnologia dei LED COB a tensione di rete ha permesso di ridurre notevolmente le dimensioni, a garanzia di un'inedita sottigliezza: il design lineare e le piccole dimensioni ne permettono l'applicazione a parete in ambienti di varia natura, dall'hospitality al residenziale.

PN110Q Applique offre una distribuzione uniforme della luce sulla facciata, senza abbagliare, e con un ridotto consumo energetico.

Il corpo in pressofusione di alluminio è dimensionato per garantire la dissipazione termica passiva.

Lo schermo frontale, elemento estetico oltre che protettivo, è in termoplastico trasparente, UV protetto, senza viti a vista. Alto grado di protezione IP 65.

Materiali:

- Corpo in pressofusione di alluminio verniciato poliestere con uno speciale trattamento antiossidante
- Base per montaggio a parete in materiale termoplastico nero
- Schermo di chiusura in materiale termoplastico trasparente ad alta resistenza, UV protetto, ad incastro senza viti di chiusura
- Schermo diffusore in policarbonato opale ad alta capacità diffondente
- Guarnizioni in silicone

PN110 Q Applique is the evolution of the exterior LED ceiling lights range of the PN family.

The sophisticated technology of mains voltage COB LED helped in reducing their size significantly.

The simple design and the small sizes allow the application on the ceiling in different locations (both in private and in public spaces, either in hotels or ships) allowing a complete design freedom.

The body in die-cast aluminum, extremely small, is designed to ensure a passive heat dissipation.

The front screen, having a decorative as well as a safety function, is in high resistant clear thermoplastic material, UV protected.

PN110 Q ceiling light can be mounted on the wall using the proper bracket, or it can be assembled together with a pole and a bracket as a bollard, ideal for paths, walkways and green spaces. High protection rating IP 65.

Materials:

- Body in die-cast aluminium, polyester painted with a special antioxidizing treatment
- Screen in high resistant, UV protected clear thermoplastic material, with no screws
- Diffuser in opal polycarbonate with high light-diffusion capacity
- Silicone gaskets

Modello di design depositato / Registered design model



PN 110Q APPLIQUE

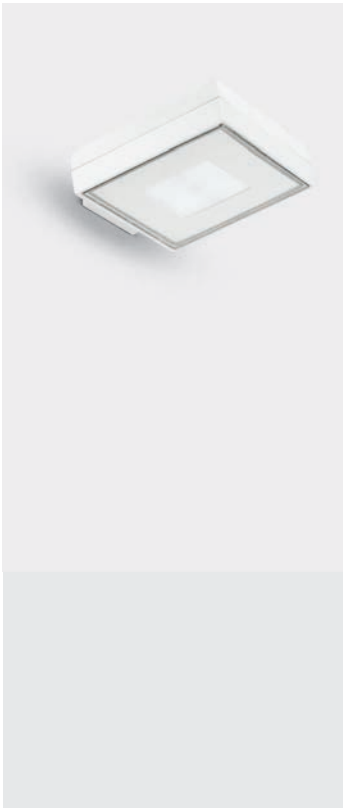

Codice Code	Colore Colour	LED Lumen	Product Lumen	Watt	Colour T (K)	CRI	Fascio Beam
144804	Bianco/White	400	320	4,3	3000	80	110°
144801	Nero/Black	400	320	4,3	3000	80	110°
144867	Ruggine/Rust	400	320	4,3	3000	80	110°

Base per attacco a parete in termoplastico
Base for wall mounting in thermoplastic material

1635104	Bianco/White
1635101	Nero/Black
1635167	Ruggine/Rust

Le plafoniere devono essere ordinate separatamente
Ceiling fittings should be ordered separately

Con LED a tensione di rete
With supply voltage LED

220/240V - 50/60Hz



1448

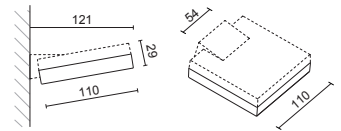

0,3kg

1635

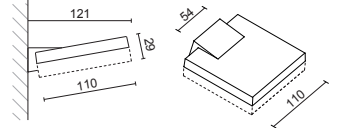

0,1kg

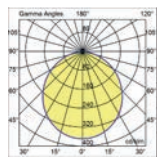

110°

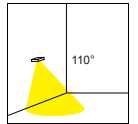



Miniten

design: **Bruno Gecchelin**

Apparecchio architettonico per luce bidirezionale **Miniten** permette di realizzare disegni di luce sulle facciate degli edifici, esaltandone i ritmi e i particolari architettonici.

Utilizza LED ad alta efficienza per un elevato rendimento e ottima resa cromatica.

E' caratterizzato da un elevato grado di protezione, IP66, e da uno speciale pretrattamento delle superfici. Risulta quindi particolarmente adatta e resistente per applicazioni in esterno.

Il telaio di supporto facilita tutte le operazioni di cablaggio e montaggio.

Materiali:

- Corpo e attacco a muro in pressofusione di alluminio verniciato poliesteri nel colore metal, con speciale pretrattamento antiossidante
- Viti in acciaio inox
- Vetro di protezione temprato (3 mm), resistente agli shock termici e agli urti
- Guarnizioni silconiche

Architectural fitting for up-down lighting, designed to create light effects on the façades of buildings, enhancing the rhythm and the architectural details.

Miniten uses high efficiency LEDs for high performance and excellent colour rendering.

It features a high protection rating, IP66, and a special surface pre-treatment. It is therefore particularly suitable and resistant for outdoor applications. The wall-frame allows an easy installation and wiring.

Materials:

- Main housing and wall-frame in die-cast aluminium, with a polyester paint silver finish and with a special antioxidizing pretreatment
- Stainless steel screws
- Tempered safety glass (3 mm), shockproof and heat resistant
- Silicone gaskets

Modello di design depositato / Registered design model

MINITEN



Codice Code	Colore Colour	LED Lumen	Product Lumen	Watt	Colour T (K)	CRI	Fascio Beam
Bidirezionale Bi-directional							
10531243	Metal/Silver	2x390	2x287	2x3	3000	80	60°/60°
10231243	Metal/Silver	2x100	-	2x1,5	3500	80	60°/60°

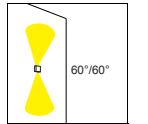
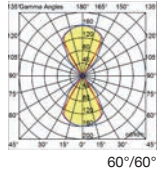
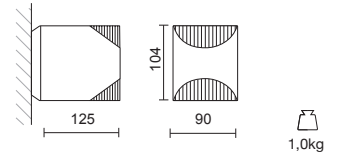

230/240V - 50/60Hz





PN 110 Q
p.272



PN 180
p.272



PN 230
p.273



PN 110 T
p.274



PN 210
p.274



PN 280
p.275



TB 300
p.277



TB 420
p.277



Luci da plafone

CEILING LIGHTS



Serie PN

design: **Enrico Davide Bona e Elisa Nobile**

La serie di plafoniere per esterni **PN** è studiata appositamente per ospitare sorgenti LED COB di ultima generazione, in grado di garantire un'elevata qualità della luce, oltre ad un considerevole risparmio energetico. Applicabile a parete o a plafone, con o senza schermatura antiabbagliante, è ideale per risolvere molteplici esigenze di illuminazione anche in ambienti interni, come atri, ingressi, balconi, portici, aree residenziali e spazi a verde in generale.

La sofisticata tecnologia dei LED a tensione di rete presente su **PN 110 Q** e **T** ha permesso di ridurre notevolmente le dimensioni, a garanzia di un'inedita sottigliezza, rendendole un'efficace alternativa a soluzioni ad incasso.

Lo schermo frontale, elemento estetico oltre che protettivo, è in termoplastico trasparente, UV protetto, senza viti a vista.

Il design ha privilegiato linee geometriche essenziali quali il quadrato e il cerchio ed uno spessore estremamente ridotto, che si coniugano armoniosamente con la sofisticata tecnologia a LED.

Alto grado di protezione IP65.

The range of exterior ceiling lights **PN** is specifically designed to be equipped with the last generation of COB LED sources and it is able to grant high lighting quality and substantial energy saving. It can be mounted on walls or ceilings with or without the anti-dazzling screen, and it is the ideal solution for many lighting demands also indoors, such as in lobbies, entrances, terraces, porches, residential areas and green spaces.

The sophisticated technology of mains voltage LED of **PN110 Q** and **T** helped in reducing their size significantly, making these fittings an effective alternative to recessed products. The front screen, having a decorative as well as a safety function, is in high resistant clear thermoplastic material, UV protected.

The design has privileged geometric essential lines, such as the square and the circle, and an extremely small thickness, combining with the sophisticated LED technology in a harmonious way.

High protection rating IP65.





Materiali:

- Corpo in pressofusione di alluminio verniciato poliesteri con speciale trattamento antiossidante a garanzia di un'elevata resistenza agli agenti atmosferici
- Schermo di chiusura in materiale termoplastico trasparente ad alta resistenza UV protetto, ad incastro, senza viti di chiusura
- Mascherina di finitura in policarbonato
- Riflettore in termoplastico metallizzato a specchio (per PN 210 e PN 280)
- Schermo diffusore in policarbonato opale ad alta capacità diffondente
- Guarnizioni in silicone



Materials:

- Body in die-cast aluminium polyester painted with a special anti-oxidizing treatment which grants a high resistance to the atmospheric agents
- Screen in high resistant UV protected clear thermoplastic material, with no screws
- Polycarbonate cover
- Reflector in mirror-metallized thermoplastic material (for PN 210 and PN 280)
- Diffuser in opal polycarbonate with high light-diffusion capacity
- Silicone gaskets

PN 110 Q

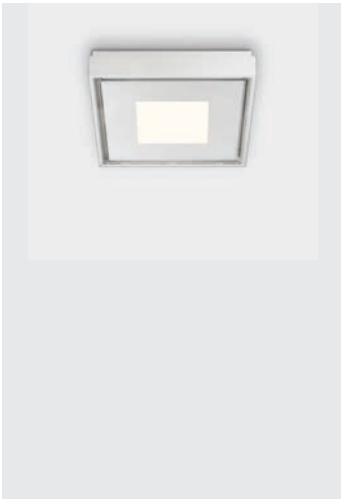

Codice Code	Colore Colour	LED Lumen	Product Lumen	Watt	Colour T (K)	CRI	Fascio Beam
144804	Bianco/White	400	320	4,3	3000	80	110°
144801	Nero/Black	400	320	4,3	3000	80	110°
144803	Metal/Silver	400	320	4,3	3000	80	110°
144867	Ruggine/Rust	400	320	4,3	3000	80	110°

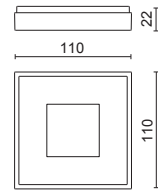

0,3kg

Per versione da facciata vedi pag.263
For facade light version see page 263

Con LED a tensione di rete
With supply voltage LED

220/240V - 50/60Hz

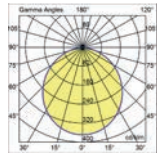
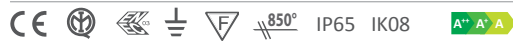

110°

PN 180



144504	Bianco/White	1700	1453	12	3000	85	110°
144501	Nero/Black	1700	1453	12	3000	85	110°
144503	Metal/Silver	1700	1453	12	3000	85	110°

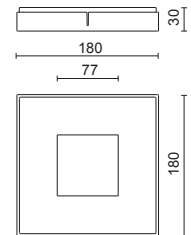

1,2kg

220/240V - 50/60Hz

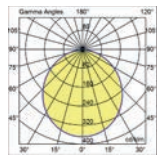
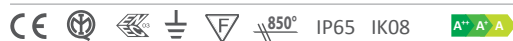

110°

PN 230



Codice Code	Colore Colour	LED Lumen	Product Lumen	Watt	Colour T (K)	CRI	Fascio Beam
144004	Bianco/White	2400	2040	18	3000	85	110°
144001	Nero/Black	2400	2040	18	3000	85	110°
144003	Metal/Silver	2400	2040	18	3000	85	110°

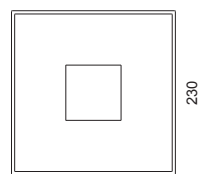
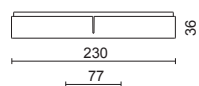

2kg

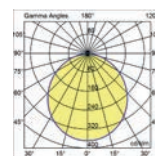

220/240V - 50/60Hz

IP65 IK08



PN 110 T



Codice Code	Colore Colour	LED Lumen	Product Lumen	Watt	Colour T (K)	CRI	Fascio Beam
144704	Bianco/White	400	320	4,3	3000	80	110°
144701	Nero/Black	400	320	4,3	3000	80	110°
144703	Metal/Silver	400	320	4,3	3000	80	110°
144767	Ruggine/Rust	400	320	4,3	3000	80	110°

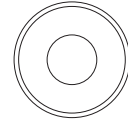
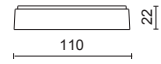

0,3kg

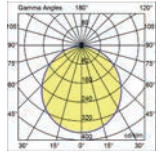

110°

Con LED a tensione di rete
With supply voltage LED

220/240V - 50/60Hz

CE IP65 IK08

PN 210



138004	Bianco/White	1800	1538	12	3000	85	120°
138001	Nero/Black	1800	1538	12	3000	85	120°
138003	Metal/Silver	1800	1538	12	3000	85	120°

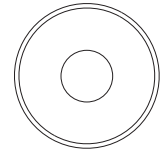
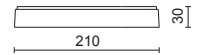

1,2kg

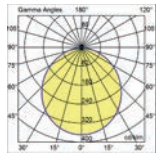

120°

230/240V - 50/60Hz

CE IP65 IK08

PN 280



Codice Code	Colore Colour	LED Lumen	Product Lumen	Watt	Colour T (K)	CRI	Fascio Beam
139004	Bianco/White	2400	2040	18	3000	85	120°
139001	Nero/Black	2400	2040	18	3000	85	120°
139003	Metal/Silver	2400	2040	18	3000	85	120°
139204	Bianco/White	3800	3230	30	3000	85	120°
139201	Nero/Black	3800	3230	30	3000	85	120°
139203	Metal/Silver	3800	3230	30	3000	85	120°

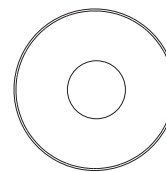
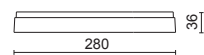

2kg

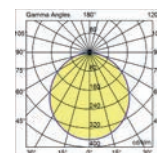

120°

230/240V - 50/60Hz



TB

design: **Bruno Gecchelin**

TB è una gamma di apparecchi da plafone disponibile in due differenti dimensioni.

L'utilizzo di LED COB ad alta efficienza e la particolare forma consentono una diffusione uniforme della luce, senza abbagliare.

Il design lineare, caratterizzato da un elegante tratteggio superficiale, consente al prodotto di integrarsi armoniosamente in svariati ambienti quali atri, ingressi, saloni, portici, aree residenziali e hospitality. Il corpo frontale con il vetro di protezione è incernierato al vano componenti e consente una manutenzione semplice.

Materiali:

- Corpo interno in tecnopolimero rinforzato F.V. 30%
- Corpo frontale in pressofusione di alluminio verniciato poliestere con pretrattamento anticorrosione
- Vetro di protezione temprato extra chiaro (8 mm), molato e acidato da entrambi i lati
- Viti esterne in acciaio inox
- Pressacavo PG9

TB is a range of ceiling fittings available in two different sizes.

The use of high efficiency COB LEDs and its particular shape provide a uniform light distribution, without glaring.

The linear design, featuring an elegant hatched surface, allows the product to be well integrated in environments such as halls, entrances, lounges, arcades, residential and hospitality areas.

The front housing with the safety glass is hinged to the gear housing, for an easy maintenance of the fitting.

Materials:

- Inner housing in technopolymer, reinforced with 30% F.G.
- Front housing in die-cast aluminium, polyester painted, with an anti-corrosion pre-treatment
- Extra clear tempered safety glass (8 mm), bevel-grinded and acid-etched on both sides
- Stainless steel external screws
- PG9 cable gland

Modello di design depositato / Registered design model



TB 300



Codice Code	Colore Colour	LED Lumen	Product Lumen	Watt	Colour T (K)	CRI	Fascio Beam
185103	Metal/Silver	1700	-	12	3000	85	120°
185104	Bianco/White	1700	-	12	3000	85	120°
1851A03	Metal/Silver	1800	-	12	4000	85	120°
1851A04	Bianco/White	1800	-	12	4000	85	120°

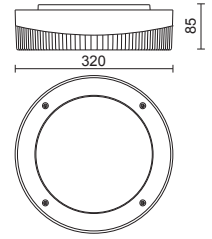

2,2kg

220/240V – 50/60Hz

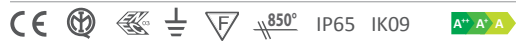

TB 420



188703	Metal/Silver	3300	-	26	3000	85	120°
188704	Bianco/White	3300	-	26	3000	85	120°
1887A03	Metal/Silver	3400	-	26	4000	85	120°
1887A04	Bianco/White	3400	-	26	4000	85	120°

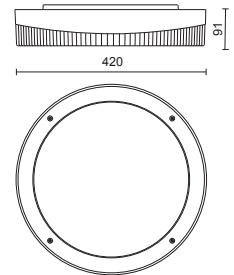

4,4kg

220/240V – 50/60Hz

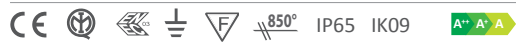







Bidi Bollard
p.285



PN 110Q Bollard
p.289



Turks
p.291



Turks
p.291



Caicos
p.293



Luci da appoggio

BOLLARDS



Bidi Bollard

design: **Enrico Davide Bona e Elisa Nobile**

Bidi Bollard è un apparecchio d'illuminazione per esterni, a luce diretta, che impiega sorgenti LED COB di ultima generazione, ad altissima efficienza. Grazie all'utilizzo del LED è stata progettata una figura verticale parallelepipedica estremamente piatta, in grado di lavorare su due fronti, con l'impiego di una o due sorgenti (versione mono o bi-emissione).

La sottigliezza dell'apparecchio è ulteriormente enfatizzata da una cornice che, su ciascuno dei due fronti, inquadra il diffusore, creando un gioco di spessori.

Bidi Bollard è composto da una base in materiale plastico per il vincolo al suolo, un corpo centrale in alluminio estruso ed una testa illuminante in pressofusione di alluminio, completa di diffusore termoplastico. Verniciato nei colori nero oppure ruggine, è ideale per applicazioni in giardini, camminamenti e in generale aree residenziali, garantito dallo speciale pre-trattamento antiossidante del palo e della testa. E' disponibile anche la versione da facciata coordinata, vedi pag. 261.

La distribuzione luminosa della luce è parallela al corpo e si diffonde in profondità.

Bidi Bollard is an exterior luminaire for direct light, equipped with high efficiency COB LED light sources of the last generation.

The use of LEDs has allowed the design of an extremely flat vertical parallelepiped, for one or two light sources. The thinness of the fitting is further emphasized by a frame which highlights the diffuser on both sides, with an innovative visual effect.

Bidi Bollard is made up of a plastic base for ground mounting, a central extruded aluminium body and a die-cast aluminium head, complete with a thermoplastic diffuser.

It is ideal for applications in gardens, walkways and in residential outdoor areas in general, thanks to the special anti-oxidizing pretreatment of the pole and of the head. It is available the coordinated façade light, see page 261. The light distribution is parallel to the body, spreading far away.



Materiali:

- Corpo in pressofusione di alluminio, verniciato poliester, con uno speciale trattamento antiossidante
- Schermo diffusore in policarbonato trasparente
- Viteria in acciaio inox
- Base in nylon nero F.V.30%

Materials:

- Body in die-cast aluminium polyester painted with a special anti-oxidizing treatment
- Diffuser in clear polycarbonate
- Stainless steel screws
- Base in black nylon F.G. 30%



BIDI BOLLARD



Codice Code	Colore Colour	LED Lumen	Product Lumen	Watt	Colour T (K)	CRI	Fascio Beam
Testa illuminante monodirezionale con ottica asimmetrica Monodirectional lighting head with asymmetric optics							
190501	Nero/Black	1x1800	1x1271	1x12	3000	85	$\alpha 40^\circ / \beta 85^\circ$
190567	Ruggine/Rust	1x1800	1x1271	1x12	3000	85	$\alpha 40^\circ / \beta 85^\circ$

Testa illuminante bidirezionale con ottiche asimmetriche Bi-directional lighting head with asymmetric optics							
190601	Nero/Black	2x1800	2x1271	2x12	3000	85	$\alpha 40^\circ / \beta 85^\circ$
190667	Ruggine/Rust	2x1800	2x1271	2x12	3000	85	$\alpha 40^\circ / \beta 85^\circ$

Palo rettangolare con base Rectangular pole with base		
1636801	Nero/Black	h 685 mm
1636867	Ruggine/Rust	h 685 mm
1636401	Nero/Black	h 265 mm
1636467	Ruggine/Rust	h 265 mm

Le teste illuminanti devono essere ordinate separatamente
Lighting heads should be ordered separately

220/240V – 50/60Hz

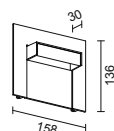
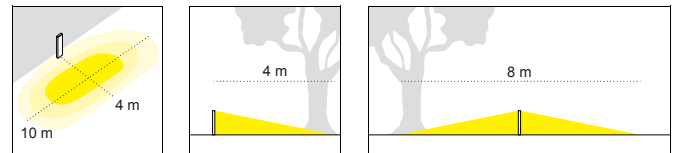
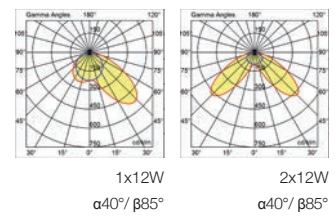
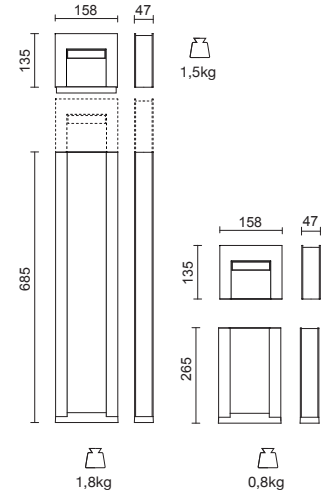

28-3955-16

Convogliatore di luce antiabbagliamento nero
Anti-dazzling light baffle in black finish

28-3955-67

Convogliatore di luce antiabbagliamento ruggine
Anti-dazzling light baffle in rust finish



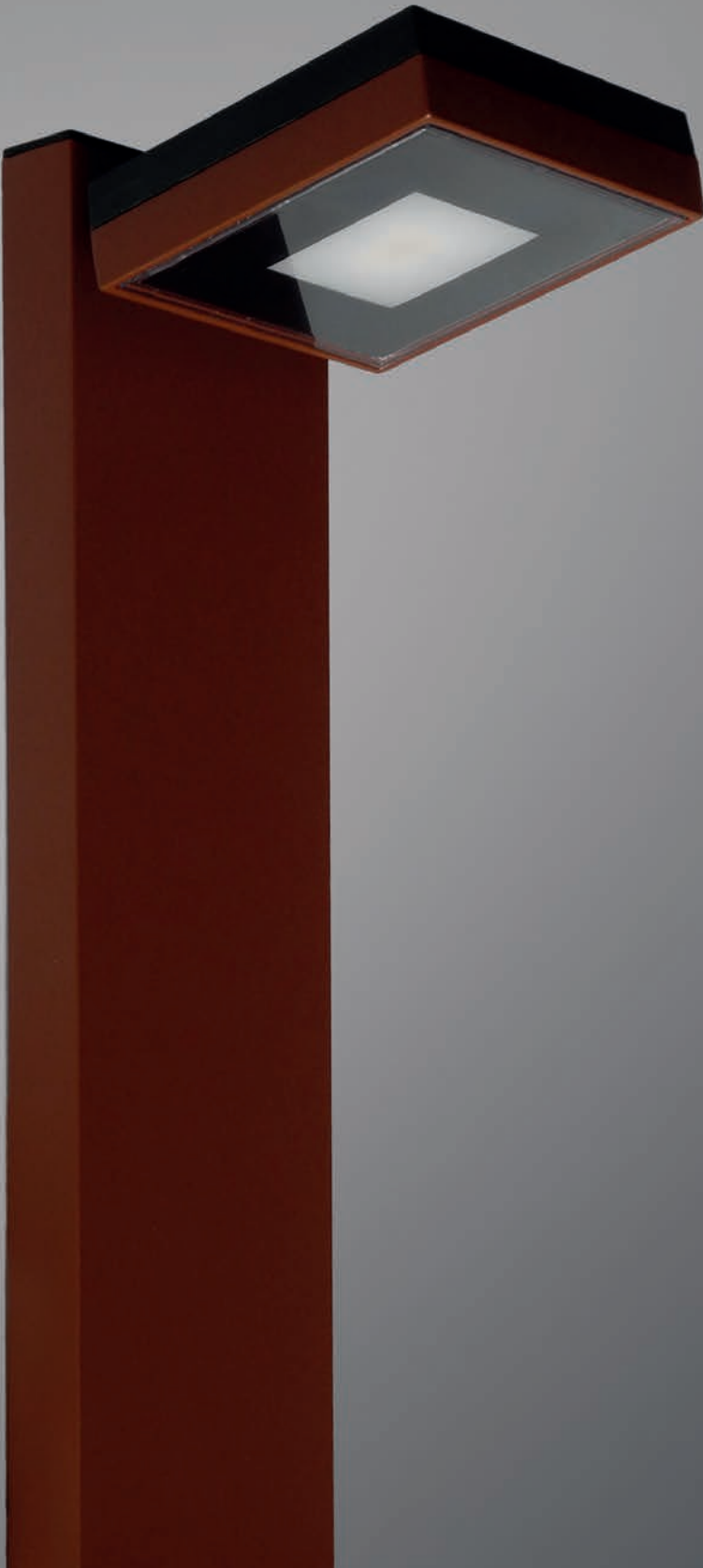

PN 110Q Bollard

design: **Enrico Davide Bona e Elisa Nobile**

PN 110Q Bollard è un paletto da esterni con LED COB che pone la plafoniera PN 110Q sulla testa di un palo rettangolare in alluminio estruso, sostenuta da una o due staffe in nylon.

PN 110Q Bollard, in versione a una o due luci, è ideale per applicazioni in giardini, zone di passaggio e aree residenziali in esterni.

Le plafoniere PN 110Q sono leggermente inclinate sulla staffa: ciò consente una diffusione della luce particolarmente ampia.

Disponibile anche l'applicazione coordinata, vedi pag. 263.

PN 110Q Bollard is an outdoor bollard with COB LED that places PN 110Q ceiling light on the top of a rectangular pole in extruded aluminium, supported by one or two nylon brackets.

PN 110Q Bollard, available in single or double version, is ideal for applications in gardens, walkways and residential outdoor areas.

The ceiling lights are slightly tilted on the bracket: this allows a particularly wide light diffusion.

A coordinated façade light version is available, see page 263.

Modello di design depositato / Registered design model





Materiali:

- Palo rettangolare in alluminio estruso verniciato poliестere con uno speciale pretrattamento antiossidante
- Base palo in nylon F.V. 30%
- Staffa in nylon F.V. 30%
- Plafoniera da ordinare separatamente in pressofusione di alluminio verniciato poliестere

Materials:

- Rectangular pole in extruded aluminium, polyester painted, with a special antioxidizing pretreatment
- Pole base in nylon F.G. 30%
- Bracket in nylon F.G. 30%
- Ceiling fitting in die-cast aluminium, polyester painted, should be ordered separately



PN 110Q BOLLARD



Codice Code	Colore Colour	LED Lumen	Product Lumen	Watt	Colour T (K)	CRI	Fascio Beam
-------------	---------------	-----------	---------------	------	--------------	-----	-------------

Testa illuminante

Lighting head

144804	Bianco/White	400	320	4,3	3000	80	110°
144801	Nero/Black	400	320	4,3	3000	80	110°
144867	Ruggine/Rust	400	320	4,3	3000	80	110°

Base per attacco a parete in termoplastico

Base for wall mounting in thermoplastic material

1635104	Bianco/White
1635101	Nero/Black
1635167	Ruggine/Rust

Palo rettangolare con base e tappo

Rectangular pole with base and cap

1631701	Nero/Black	h 720 mm	1 light
1631767	Ruggine/Rust	h 720 mm	1 light
1632701	Nero/Black	h 720 mm	2 lights
1632767	Ruggine/Rust	h 720 mm	2 lights

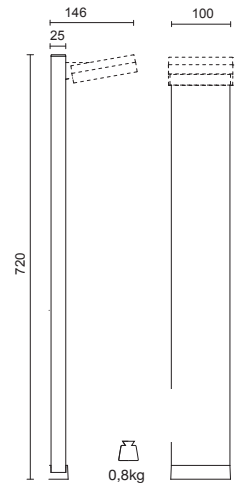
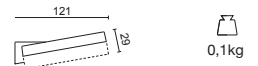
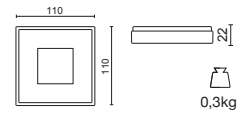

Le plafoniere devono essere ordinate separatamente
Ceiling fittings should be ordered separately

Con LED a tensione di rete
With supply voltage LED

220/240V – 50/60Hz

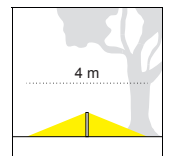
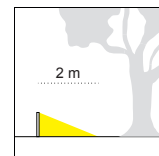
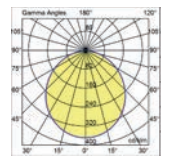
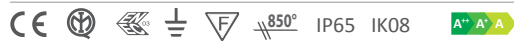



Turks

design: **Bruno Gecchelin**

Turks è un paletto per esterni a LED dal design essenziale, in grado di realizzare effetti luminosi decorativi e giochi di luce e ombra, perfetto in aree pedonali, vialetti, terrazze, loggiati, giardini pubblici e privati.

Turks è disponibile in due misure. La versione più bassa si integra armoniosamente anche sulle facciate degli edifici.

Gli apparecchi montano 3 LED ad alta efficienza luminosa che associano bassi consumi, lunga durata e minima manutenzione.

Turks è particolarmente resistente alla penetrazione delle polveri e all'acqua (IP66) ed è dotato, nella versione più bassa, di picchetto in termoplastico per l'ancoraggio al terreno.

Materiali:

- Corpo in termoplastico rinforzato F.V. 30%, con elemento centrale verniciato metal
- Corpo cilindrico inferiore in alluminio estruso con trattamento antiossidante e verniciato poliester
- Schermi di protezione in policarbonato
- Pressacavo M12 per cavo in gomma

Turks is an outdoor bollard featuring an essential design, ideal to create decorative light effects and contrasts between light and shadow in pedestrian areas, lanes, terraces, open galleries, public and private gardens. It is available in two dimensions: the lowest version is ideal for the façades of buildings.

The fittings are equipped with 3 high efficiency LEDs which combine energy saving, long life and minimum maintenance.

Turks is particularly resistant to the penetration of dust and water (IP66) and it is provided with a spike in thermoplastic material for anchoring to the ground (only for the lowest version).

Materials:

- Housing in thermoplastic reinforced with 30% fibreglass, with a silver painted central unit
- Lower cylindrical housing in extruded aluminium with anti-oxidizing pre-treatment, polyester painted
- Polycarbonate safety screens
- Cable gland M12 for rubber cable

Modello di design depositato / Registered design model



TURKS



Codice Code	Colore Colour	LED Lumen	Product Lumen	Watt	Colour T (K)	CRI
1803130	Nero/Black	300 (3 Led)	-	3	3000	80
1803120	Metal/Silver	300 (3 Led)	-	3	3000	80

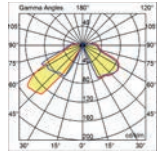
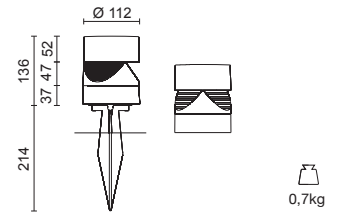

230/240V – 50/60Hz

CE 850° IP66



1813130	Nero/Black	300 (3 Led)	-	3	3000	80
1813120	Metal/Silver	300 (3 Led)	-	3	3000	80

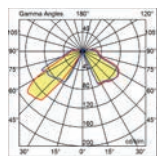
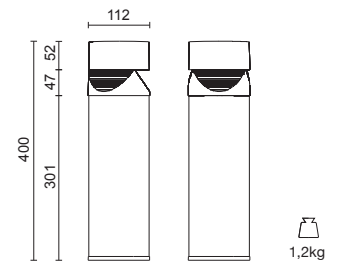

230/240V – 50/60Hz

CE 850° IP66

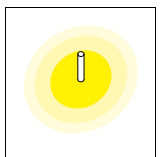



Caicos

design: **Bruno Gecchelin**

Il paletto per esterni **Caicos** è in grado di rispondere a molteplici esigenze funzionali ed estetiche. Il suo design essenziale e dalle linee pulite è ideale per illuminare in modo discreto e uniforme, con dispersione di luce ridotta, percorsi pedonali, camminamenti e aree commerciali, pubbliche e residenziali. **Caicos** è un apparecchio a luce diretta e illuminazione diffusa a 360°, con diffusore in policarbonato trasparente. E' accessoriabile con un frangiluce ad alette, in alluminio pretrattato, ideale per direzionare il fascio di luce verso il basso, riducendo l'abbagliamento. Doppio isolamento: classe II. Alto grado di protezione IP66.

Materiali:

- Corpo in estrusione di alluminio verniciato poliesteri con trattamento antiossidante
- Diffusore in policarbonato trasparente
- Basetta in tecnopolimero rinforzato F.V. 30%

The bollard **Caicos** is able to meet many functional and aesthetic demands. Its essential design, featuring clean lines, is ideal for creating discrete and uniform lighting, considerably reducing dispersion of light in pedestrian routes, walkways as well as in commercial, public and residential areas. **Caicos** provides direct light with diffused illumination (over 360°) and it is supplied with a clear polycarbonate diffuser. It can be supplied with a light refractor accessory, with flaps in pre-treated aluminium, ideal to direct the beam of light downwards, reducing the glare. Class II, double insulation. High IP66 rating.

Materials:

- Body in extruded aluminium, polyester-painted, with an anti-oxidation treatment
- Clear polycarbonate diffuser
- Base in techno-polymer reinforced with 30% fibreglass

Modello di design depositato / Registered design model



CAICOS



Codice Code	Colore Colour	Lampada Lamp	Watt	Attacco Base	Colour T (K)
190311	Nero/Black	FSQ incl.	26	G24q-3	3000

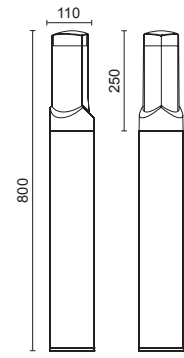

1,9kg

230/240V - 50/60Hz

CE 850° IP66 IK10

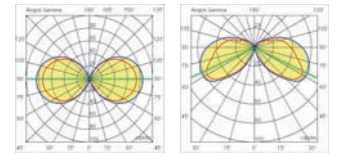

con frangiluce
with refractor

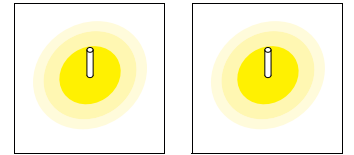

160700

Frangiluce ad alette
Refractor with flaps



160821

Bobina di cavo di alimentazione H05RN-F 2x1mm², 10mt
10mt supply cable coil H05RN-F 2x1mm²



84108

Connettore stagno
Rated cable connector









Nauto 230
p.300



Nauto
p.301



Walker Led
p.303



Walker
p.303



Walker
p.303



Achille 190 Led
p.305



Achille 320 Led
p.306



Achille 320
p.307



Achille 450 Led
p.308



Stilled
p.311



Stillens
p.311



Walled
p.312



Serie 500
p.313



Serie 500
p.313



Luci da incasso per esterni

EXTERIOR RECESSED LIGHTS



Nauto

Studio Tecnico Ivela

Nauto è un incasso LED calpestabile da pavimento, con cornice tonda in acciaio inox spazzolato, anche in versione con LED a tensione di rete di ultima generazione. Perfettamente integrabile nella pavimentazione, è idoneo per l'installazione in superfici tradizionali o industriali ed è ideale come luce segnapasso e decorativa in numerose applicazioni.

Nauto è adatto per l'illuminazione in immersione costante sino a 3 metri di profondità, grazie al suo alto grado di protezione IP68.

Nauto 230 con LED COB a tensione di rete, è disponibile in due versioni: con schermo diffusore in policarbonato trasparente e ottica 20° oppure con schermo in policarbonato opale per luce diffusa.

Il corpo è completo di controcassa da cementare con uno o due pressacavi per il collegamento elettrico a cascata e cavi di alimentazione da 5 mt (per Nauto 230). Il fondo è forato per permettere il drenaggio.

Materiali:

- Corpo e controcassa in tecnopolimero ad alta resistenza
- Cornice di finitura e viti in acciaio inox
- Schermo diffusore in policarbonato opale oppure trasparente, resistente a carichi fino a 1000 Kg
- Riflettore sfaccettato in termoplastico metallizzato (dove previsto)
- Singolo o doppio pressacavo per collegamenti a cascata
- Cavi di alimentazione H05RN-F 2x1 mm², 5 mt (dove previsto)
- Doppia guarnizione in EPDM

Nauto is a recessed in-ground walk-over LED light, with a round stainless steel ring, also with supply voltage LED of last generation.

It can be perfectly fitted in the floor, it is suitable for multiple applications in traditional or in industrial surfaces, and it is ideal as step light and marker in many applications.

Nauto is suitable for the illumination in permanent immersion up to 3 meters depth thanks to its high protection rating IP68.

Nauto 230 with mains voltage COB LED, is available in two versions, either with diffuser in clear polycarbonate and 20° reflector, or in opal polycarbonate for diffused lighting.

The body is complete with a recessed housing for in-ground installation, with one or two cable glands and 5 meters supply cable (for Nauto 230). The bottom has holes to allow drainage.

Materials:

- Inner and recessed housing in high-resistant technopolymer
- Round stainless steel ring and screws
- Shockproof, hard-wearing opal or clear polycarbonate diffuser, load-resistant up to 1000 Kg
- Faceted reflector in metallized thermoplastic material (where applicable)
- Single or double cable gland for through-wiring
- 5 meters supply cable H05RN-F 2x1 mm² (where applicable)
- Double EPDM gasket



NAUTO 230

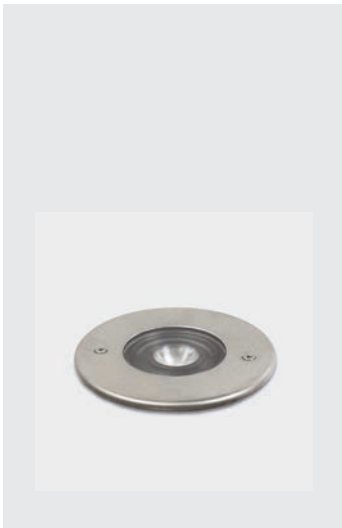

Codice Code	Linea Line	LED Lumen	Product Lumen	Watt	Colour T (K)	CRI	Fascio Beam
-------------	------------	-----------	---------------	------	--------------	-----	-------------

Diffusore trasparente
Clear diffuser

1557100	1	400	320	4,3	3000	80	20°
1557200	2	400	320	4,3	3000	80	20°

Diffusore opale
Opal diffuser

1558100	1	400	320	4,3	3000	80	110°
1558200	2	400	320	4,3	3000	80	110°

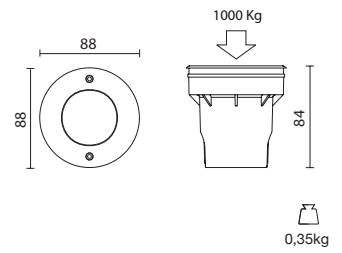

Controcassa in dotazione nell'apparecchio
Recessed housing included in the fitting

Con LED a tensione di rete
With supply voltage LED

230/240V - 50/60Hz

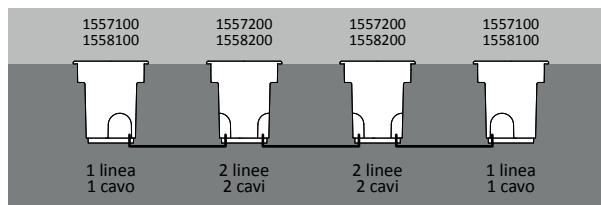
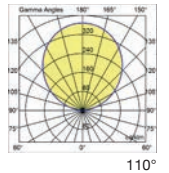

28-0219-79

Cornice quadra in acciaio inox
Stainless steel square frame



160821

Bobina di cavo di alimentazione H05RN-F 2x1mm², 10mt
10mt supply cable coil H05RN-F 2x1mm²



84108

Connettore stagno
Rated cable connector

NAUTO

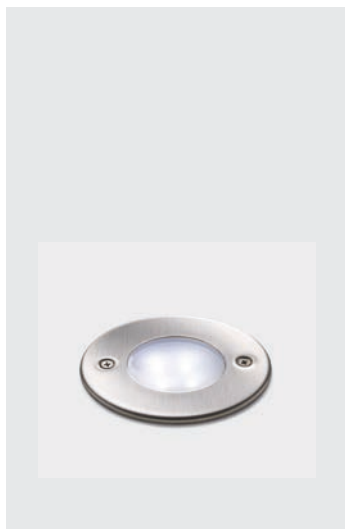

Codice Code	LED Lumen	Product Lumen	Watt	Colour T (K)	CRI	T max (°C)
Per LED driver a corrente costante (cod. 81-04020) Constant current LED driver required (cod. 81-04020)						
1563180	300 (3 Led)	-	3	bianco/white 3000	80	55°
Per LED driver a 10VDC (cod. 81-04005) 10Vdc LED driver required (cod. 81-04005)						
1523180	16 (4 Led)	-	0,5	bianco/white 3500	80	40°
1526480	- (4 Led)	-	0,5	blu/blue	-	40°
Per LED driver a 24VDC (cod. 81-04006) 24Vdc LED driver required (cod. 81-04006)						
1543180	180 (9 Led)	-	1,5	bianco/white 3500	80	40°
1546480	- (9 Led)	-	1,5	blu/blue	-	40°

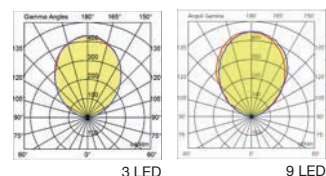
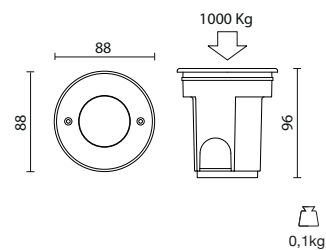

Controcassa in dotazione nell'apparecchio
Recessed housing included in the fitting

CE, RoHS, Energy Star, IP68, IK10, A++ A+ A

Driver da ordinare separatamente Drivers should be ordered separately		81-04020	15 W	Corrente costante - Output 350mA - Max 4 pz ogni 30mt Constant current - Output 350mA - Max 4 pc. max distance 30mt
		81-04005	10 W	Tensione costante - Output 10VDC - Max 20 pz ogni 30mt Constant voltage - Output 10Vdc - Max 20 pc. max distance 30mt
		81-04006	20 W	Tensione costante - Output 24VDC - Max 13 pz ogni 30mt Constant voltage - Output 24Vdc - Max 13 pc. max distance 30mt



28-0219-79

Cornice quadra in acciaio inox 88x88 mm
Stainless steel square frame 88x88 mm



160821

Bobina di cavo di alimentazione H05RN-F 2x1mm², 10mt
10mt supply cable coil H05RN-F 2x1mm²



84108

Connettore stagno
Rated cable connector



Walker

Studio Tecnico Ivela

La gamma **Walker** è composta da apparecchi da incasso a filo terreno, ideali per evidenziare percorsi e mettere in risalto il verde e gli spazi naturali creando nel contempo atmosfere d'effetto.

Incassi carrabili, facili da installare e perfettamente integrabili nell'ambiente. Disponibili versioni con cornice in acciaio inox o con schermo diffusore trasparente. Progettati per integrare lampade alogene a tensione di rete con riflettore dicroico e LED ad alta efficienza di ultima generazione.

Foro d'ingresso del cavo d'alimentazione completo di pressacavo PG11 nella parte inferiore del corpo da inserire nel vano. Per l'installazione prevedere un adeguato drenaggio.

Materiali:

- Controcassa da cementare e corpo in tecnopolimero ad alta resistenza
- Cornice di finitura in acciaio inox spazzolato (dove previsto)
- Viti in acciaio inox
- Diffusore in policarbonato opale 12 mm
- Vetro interno satinato antiabbagliante (dove previsto)
- Doppia guarnizione in EPDM

The **Walker** range consists of recessed fittings flush in the ground, ideal to mark walkways and to add value to green areas and natural environments.

Drive-over recessed uplights, easy to install and suitable for any background. Versions with a stainless steel frame or with a clear diffuser are available.

Versions for mains voltage halogen lamps with dichroic reflector and with a high efficiency LED of last generation are available.

The hole for the supply cable is in the lower part of the inner housing, including PG11 cable-gland, to be fitted in the recessed housing. An appropriate drainage should be provided for the installation.

Materials:

- Recessed housing for in-ground installation and inner housing in high resistant technopolymer
- Stainless steel ring (where applicable)
- Stainless steel screws
- 12 mm opal polycarbonate diffuser
- Anti-dazzling interior satined glass (where applicable)
- Double EPDM gasket

WALKER LED



Codice Code	LED Lumen	Product Lumen	Watt	Colour T (K)	CRI	Fascio Beam	T max (°C)
1553181	650	281	6,5	3000	80	100°	60°

Cornice in acciaio inox
Stainless steel frame

Controcassa in dotazione nell'apparecchio
Recessed housing included in the fitting

230/240V - 50/60Hz

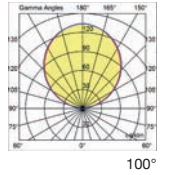
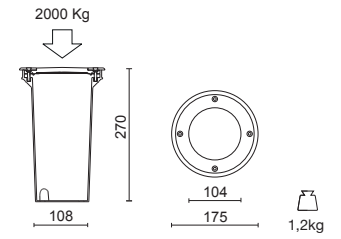

WALKER

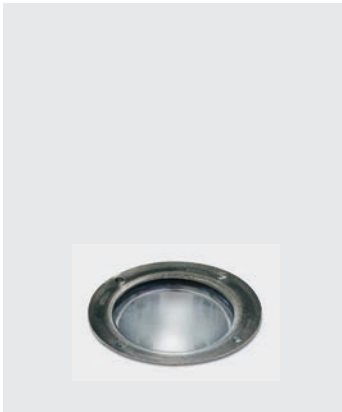

Codice Code	Lampada Lamp	Watt	Attacco Base	T max (°C)
155100	IRR63	40	E27	100°

Controcassa in dotazione nell'apparecchio
Recessed housing included in the fitting

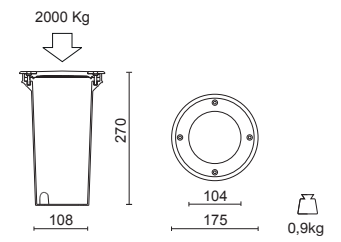

WALKER

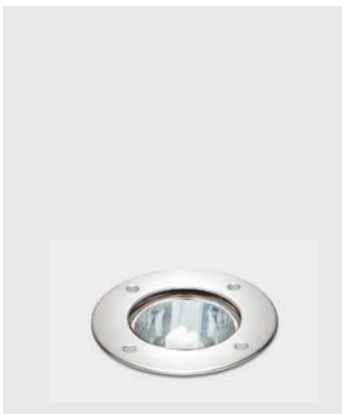

Codice Code	Lampada Lamp	Watt	Attacco Base	T max (°C)
155180	IRR63	40	E27	100°
155280	IPARD16	50	GZ10	100°

Cornice in acciaio inox
Stainless steel frame

Controcassa in dotazione nell'apparecchio
Recessed housing included in the fitting

50W: 250V - 50/60Hz

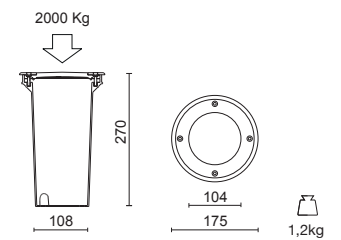

160821

Bobina di cavo di alimentazione H05RN-F 2X1 mm², 10 mt
10 mt supply cable coil H05RN-F 2X1 mm²



84108

Connettore stagno
Rated cable connector



160965

Griglia frangiluce in acciaio
Steel refractor grid

Achille

Studio Tecnico Ivela

La gamma **Achille** è costituita da apparecchi da incasso a filo terreno, ideali per illuminare facciate di edifici, monumenti, giardini, mettendo in risalto architetture e spazi verdi.

Calpestabili e carrabili, sono costruiti con materiali altamente resistenti agli agenti di corrosione e possiedono un elevato grado di protezione IP67, risultando affidabili nel tempo e adatti per applicazioni anche in condizioni atmosferiche gravose.

Apparecchi in classe II.

Sono disponibili tre modelli, differenti nel diametro, con ottiche simmetriche orientabili o fisse. La serie **Achille** è progettata per lampade a ioduri metallici ad alta efficienza e con LED COB di ultima generazione.

Per l'installazione prevedere un adeguato drenaggio.

Materiali:

- Corpo e controcassa in materiale termoplastico ad alta resistenza
- Cornice e viti in acciaio inox
- Riflettori in tecnopolimero metallizzato a specchio (per versioni a LED) o in alluminio purissimo 99.9
- Vetro di chiusura temprato, con guarnizioni silconiche a tenuta IP67
- Vetro interno temprato di 4 mm (no per Achille 190 LED)
- Scatola di collegamento cablaggio in materiale termoplastico con doppio pressacavo per cavi in gomma

The **Achille** range consists of recessed uplights installed flush in the ground, ideal for façades, monuments and gardens, highlighting architectural and green areas. Suitable for vehicles and pedestrian traffic, they are designed with materials that preserve them from the aggression of oxidizing agents. They have a high rating IP67, thus being reliable over time and suitable for application, even in severe weather conditions.

Fittings in class II.

Three models are available, with different diameters and including symmetrical, adjustable or fixed optics.

The **Achille** range is designed for high efficiency metal halide lamps and COB LEDs of last generation.

An appropriate drainage should be provided for the installation.

Materials:

- Housing and recessed housing in high-resistant thermoplastic material
- Stainless steel ring and screws
- Mirror-metallized technopolymer reflectors (for LED versions) or in 99,9 pure aluminium
- Outer tempered glass, with silicon gaskets IP67
- 4mm inner tempered glass (not for Achille 190 LED)
- Junction box in thermoplastic material with a double cable-gland for rubber cables



ACHILLE 190 LED

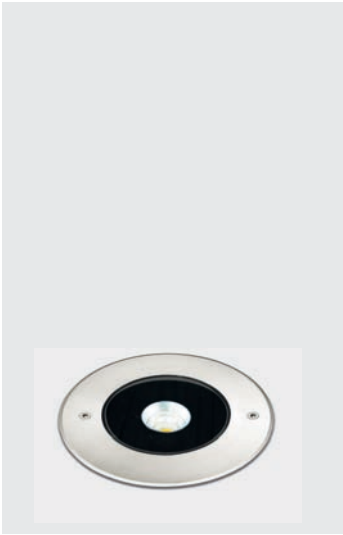

Codice Code	LED Lumen	Product Lumen	Watt	Colour T (K)	CRI	Fascio Beam	T max (°C)
Ottica orientabile +/-7° +/-7° adjustable reflector							
149401	1800	1530	12	3000	85	26°	40°
149501	2500	2125	18	3000	85	26°	40°

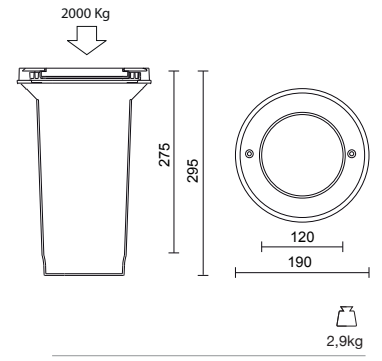

Controcassa in dotazione nell'apparecchio
 Recessed housing included in the fitting

12W: 230/240V - 50/60Hz
 18W: 220/240V - 50/60Hz

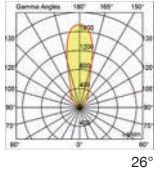

Accessori ottici intercambiabili Replaceable optical accessories

			12W	18W
	28-9001-51	Ottica professionale S Professional optic device S		
	28-9002-51	Ottica professionale M Professional optic device M		
	28-9003-51	Ottica professionale W Professional optic device W		



160821

Bobina di cavo di alimentazione H05RN-F 2X1 mm², 10 mt
 10 mt supply cable coil H05RN-F 2X1 mm²

ACHILLE 320 LED

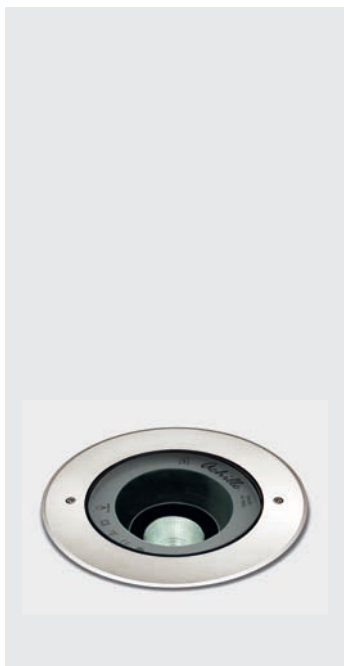

Codice Code	LED Lumen	Product Lumen	Watt	Colour T (K)	CRI	Fascio Beam	T max (°C)
Ottica orientabile +/-15° +/-15° adjustable reflector							
147900	2500	1944	18	3000	85	30°	35°
148000	4100	3190	27	3000	85	25°	35°

Controcassa da ordinare separatamente
Recessed housing to be ordered separately

160348

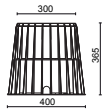

220/240V - 50/60Hz

CE, RoHS, Energy Star, IP67 IK10, A++ A+ A

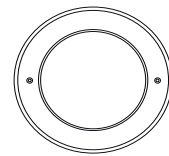
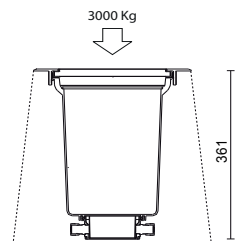

7,2kg

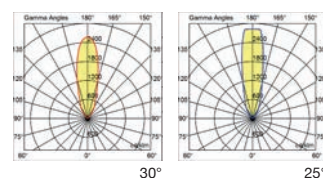

Ottiche professionali in termoplastico metallizzato a specchio Professional optic in thermoplastic mirror-metallized



28-3140-51

Ottica professionale S
Professional optic device S



28-3142-51

Ottica professionale M
Professional optic device M



28-3138-51

Ottica professionale W
Professional optic device W



28-3141-31

Ottica professionale XW
Professional optic device XW



28-3957-30

Cilindro antiabbagliamento
Snoot



28-3959-30*

Frangiluce alveolare
Honeycomb

18W 27W

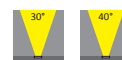

* Da utilizzare esclusivamente insieme a snoot cod. 28-3957-30

* To be used only with snoot code 28-3957-30



ACHILLE 320



Codice Code	Lampada Lamp	Watt	Attacco Base	Fascio Beam	T max (°C)	Kg
Ottica orientabile +/-15° (su richiesta) +/-15° adjustable reflector (on demand)						
148400	MT	70	G12	33°	115°	7,2
148500	MT	150	G12	93°	165°	8,0

Controcassa da ordinare separatamente
Recessed housing to be ordered separately

160348

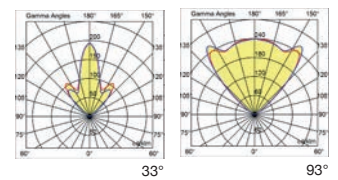
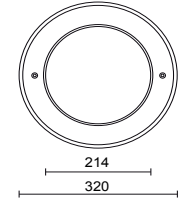
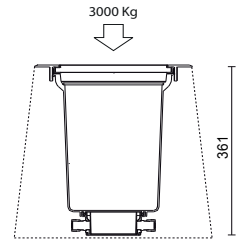

230V - 50Hz

IP67 IK10



ACHILLE 450 LED

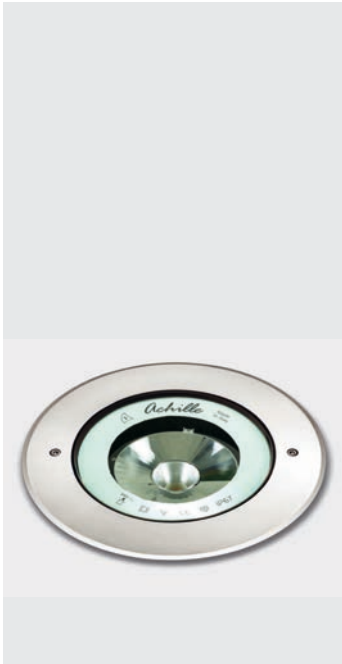

Codice Code	LED Lumen	Product Lumen	Watt	Colour T (K)	CRI	Fascio Beam	T max (°C)
-------------	-----------	---------------	------	--------------	-----	-------------	------------

Ottica orientabile 15°
Adjustable reflector

147000	6800	-	51	3000	85	25°	40°
---------------	-------------	---	----	------	----	-----	-----

Controcassa da ordinare separatamente
Recessed housing to be ordered separately

160349

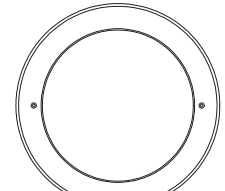
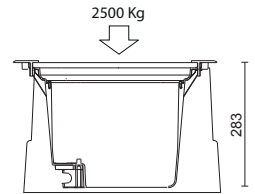

11,8kg

230/240V - 50/60Hz



Accessori ottici intercambiabili Replaceable optical accessories



28-3140-51

Ottica professionale S
Professional optic device S

51W



28-3142-51

Ottica professionale M
Professional optic device M



28-3138-51

Ottica professionale W
Professional optic device W



28-3141-31

Ottica professionale XW
Professional optic device XW



28-3957-30

Cilindro antiabbagliamento
Snoot

* Da utilizzare esclusivamente insieme a snoot cod. 28-3957-30



28-3959-30*

Frangiluce alveolare
Honeycomb

* To be used only with snoot code 28-3957-30





Stilled & Stillens

Studio Tecnico Ivela

Incassi a LED, dal design essenziale, che si adattano a differenti ambienti sia esterni che interni, e possono essere applicati sia a parete, per soluzioni scenografiche, sia a terra, per scandire le zone di passaggio.

Stilled, calpestabile e perfettamente integrabile in ogni superficie, è utile per evidenziare percorsi e vie di uscita o per creare effetti luminosi.

Stillens, adatto per applicazioni a parete, è corredato di lente ottica per il fascio luminoso.

L'elevato grado di protezione IP68 rende questi apparecchi idonei anche per applicazioni in immersione costante fino a 3 metri di profondità.

Sono forniti completi di controcassa.

Materiali:

- Corpo e controcassa da cementare in tecnopolimero ad alta resistenza
- Cornici di finitura e viti in acciaio inox
- Schermo diffusore in policarbonato trasparente
- Doppio pressacavo per collegamenti a cascata
- Doppia guarnizione in EPDM

Recessed LED fittings, with an essential design, ideal for different applications in outdoors and indoors. They are suitable both for wall mounting, for scenographic solutions, and installation in the ground to mark walkways.

Stilled is suitable for the passage of pedestrians and it can be perfectly integrated into any surface. It is useful for the safe illumination of footpaths and exit ways, or to create light effects along walls.

Stillens, suitable for wall applications, is equipped with a lens to create beams of light.

The high protection rating IP68 makes these fittings fit for application in permanent immersion up to 3 meters depth. They come complete with the recessed housing.

Materiali:

- Inner and recessed housing in high-resistant technopolymer
- Stainless steel frame and screws
- Diffuser screen in clear polycarbonate
- Double cable gland for through wiring
- Double EPDM gasket

STILLED

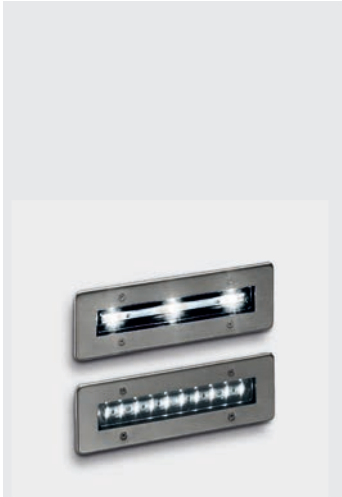

Codice Code	LED Lumen	Product Lumen	Watt	Colour T (K)	CRI	T max (°C)
-------------	-----------	---------------	------	--------------	-----	------------

Per LED driver a corrente costante (cod. 81-04020)
Constant current LED driver required (cod. 81-04020)

1583180	300 (3 Led)	-	3	bianco/white 3000	80	55°
----------------	-------------	---	---	-------------------	----	-----

Per LED driver a 24Vdc (cod. 81-04006)
24Vdc LED driver required (cod. 81-04006)

1513180	- (10 Led)	-	1	bianco/white 3500	80	40°
----------------	------------	---	---	-------------------	----	-----

Controcassa in dotazione nell'apparecchio
Recessed housing included in the fitting

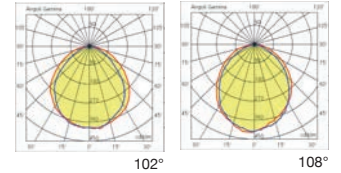
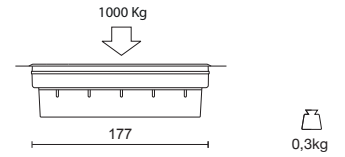
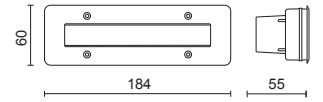

STILLENS



Per LED driver a corrente costante (cod. 81-04020)
Constant current LED driver required (cod. 81-04020)

1533180	300 (3 Led)	-	3	bianco/white 3000	80	-
----------------	-------------	---	---	-------------------	----	---

Controcassa in dotazione nell'apparecchio
Recessed housing included in the fitting

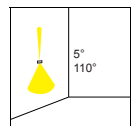
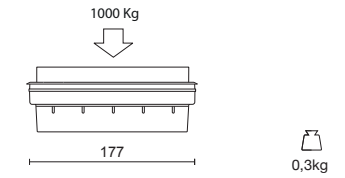
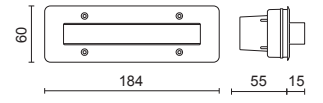

Driver da ordinare separatamente
Drivers should be ordered separately



81-04020 15 W Corrente costante - Output 350mA - Max 4 pz ogni 30mt
Constant current - Output 350mA - Max 4 pc. max distance 30mt

81-04006 20 W Tensione costante - Output 24Vdc - Max 13 pz ogni 30mt
Constant voltage - Output 24Vdc - Max 13 pc. max distance 30mt



160821 Bobina di cavo di alimentazione H05RN-F 2x1mm², 10mt
10mt supply cable coil H05RN-F 2x1mm²



84108 Connettore stagno
Rated cable connector





Walled

Studio Tecnico Ivela

Incasso di piccole dimensioni, in versioni da 12 e 18 LED, è ideale per essere inserito a parete come segnapasso. Lo schermo in policarbonato diffonde la luce in modo omogeneo. Fornito completo di controcassa.

Materiali:

- Corpo, cornice e controcassa in policarbonato
- Cornice verniciata metal
- Schermo diffusore in policarbonato opacizzato
- Viti in acciaio inox
- Guarnizioni in EPDM

Small recessed fitting, in 12 or 18 LED versions, ideal for recessed wall mounting, for the illumination of walkways. The polycarbonate screen allows a homogeneous light diffusion. It includes the recessed housing.

Materials:

- Polycarbonate inner housing, recessed housing and silver painted frame
- Diffuser in opal polycarbonate
- Stainless steel screws
- EPDM gaskets

WALLED



Codice Code	LED Lumen	Product Lumen	Watt	Colour (K)	CRI
Per LED driver a 10VDC (cod. 81-04005) 10VDC LED driver required (cod. 81-04005)					
1573120	48	-	1,5	3500	80
Per LED driver a 24VDC (cod. 81-04006) 24VDC LED driver required (cod. 81-04006)					
1593120	72	-	3	3500	80

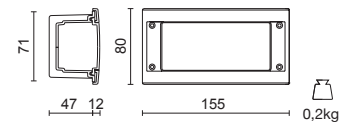

Controcassa in dotazione nell'apparecchio
Recessed housing included in the fitting



Driver da ordinare separatamente
Drivers should be ordered separately



81-04005

10 W

Tensione costante - Output 10VDC - Max 6 pz ogni 30mt
Constant voltage - Output 10Vdc - Max 6 pc. max distance 30mt

81-04006

20 W

Tensione costante - Output 24VDC - Max 6 pz ogni 30mt
Constant voltage - Output 24Vdc - Max 6 pc. max distance 30mt



Serie 500

Studio Tecnico Ivela

Incasto da muro, ideale per illuminare gradini, muretti, ingressi. Alto grado di protezione IP65. Installazione facile e veloce: dopo il fissaggio della controcassa nel muro, si inserisce il corpo dell'apparecchio, che può essere regolato per correggere eventuali imperfezioni del posizionamento.

Materiali:

- Controcassa, corpo e griglia in termoplastico ad alta resistenza.
- Riflettore in alluminio.
- Vetro diffusore temprato e satinato.
- Viti in acciaio inox.

Wall light for recessed mounting, it is ideal for the illumination of gardens, walls and porches. High protection rating IP65. Quick and easy installation: the body of the fitting, which can be adjusted to amend possible imperfections in its positioning, can be installed after fixing the recessed box into the wall.

Materials:

- Recessed back box, housing and grid in high-resistant thermoplastic.
- Aluminium reflector.
- Tempered satin glass.
- Stainless steel screws.

SERIE 500



Codice Code	Colore Colour	Lampada Lamp	Watt	Attacco Base
150300	⚡ Nero/Black	FSQ	26	G24d-3
150301	⚡ Bianco/White	FSQ	26	G24d-3
150000	☐ Nero/Black	HE	60	E27
150001	☐ Bianco/White	HE	60	E27
150002	☐ Grigio/Grey	HE	60	E27

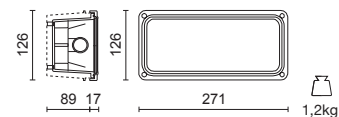

Controcassa in dotazione nell'apparecchio
Recessed housing included in the fitting
26W: 230V - 50Hz

CE M E F IP65 IK08

SERIE 500 CON GRIGLIA/WITH GRID



150400	Nero/Black	HE	40	E27
150401	Bianco/White	HE	40	E27
150402	Grigio/Grey	HE	40	E27

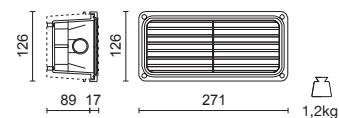

Controcassa in dotazione nell'apparecchio
Recessed housing included in the fitting

CE M E F IP65 IK08



84108

Connettore stagno
Rated cable connector



250T
p.317



270T
p.317



270TP
p.317



295T
p.318



295TP
p.318



312T
p.319



340T
p.319



380T
p.320



430T
p.320



270
p.322



270P
p.322



295P
p.323



330
p.323



Sfere
p.324



Sfere con adattatore
p.324



Applique 20
p.326



Applique 25
p.326



Base 19
p.326



Pali/Accessori
p.327



Plafoniere

CEILING LIGHTS

Plafoniere



Le **plafoniere** per esterni sono disponibili in un'ampia gamma che comprende apparecchi di misure differenti, con LED ad alta efficienza e risparmio energetico e per lampade alogene e fluorescenti compatte.

Ideali per applicazioni in ambienti residenziali e condominiali, sia per interni che per esterni. Elevato grado di protezione IP65/66.

Alta resistenza agli impatti meccanici esterni.

Le plafoniere 295, 295P, 295T e 295TP sono modelli di design depositato.

Materiali:

- Corpo in nylon F.V. 30%
- Diffusore in policarbonato
- Stampati ad iniezione
- Tensione di alimentazione: elettronica 230/240V - 50/60Hz; elettromagnetica 230V - 50Hz

The **outdoor ceiling** luminaires are available in a wide range of versions in different sizes, with high efficiency and energy saving LED sources as well as for halogen and compact fluorescent lamps.

Ideal for application in residential areas for both indoor and outdoor use. High protection rating IP65/66. High resistance against mechanical shocks.

The 295, 295P, 295T and 295TP ceiling luminaires are registered design models.

Materials:

- Body in nylon F.G. 30%
- Polycarbonate diffuser
- Injection molded
- Supply voltage: electronic 230/240V - 50/60Hz; electromagnetic 230V - 50Hz



250T

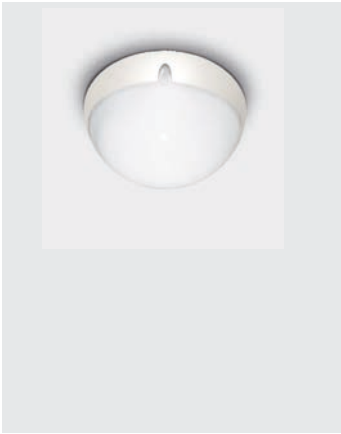

Codice Code	Colore Colour	Lampada Lamp	Watt	Colour T (K)	Attacco Base	Kg
137400	Bianco/White	F5Q incl.	26	3000	G24q-3	0,7
137000	Bianco/White	HE 60W/FBT 11W	-	-	E27	0,6
137001	Nero/Black	HE 60W/FBT 11W	-	-	E27	0,6

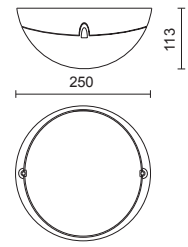

CE IP66 IK10

270T

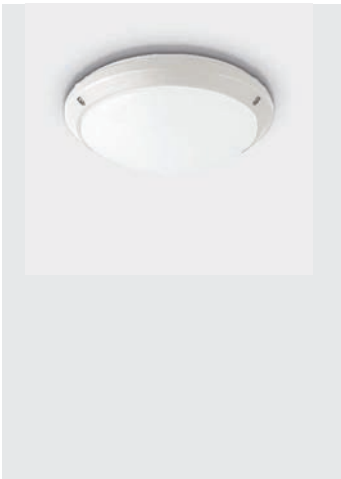

Codice Code	Colore Colour	Lampada Lamp	LED Lumen	Product Lumen	Watt	Colour T (K)	CRI	Attacco Base	Kg
126300	Bianco/White	LED	1700	1190	11	3000	85	-	1,0
127601	Bianco/White	F5Q	-	-	18	-	-	G24d-2	0,9
127400	Bianco/White	HE 75W/FBT 15W	-	-	-	-	-	E27	0,6
127401	Nero/Black	HE 75W/FBT 15W	-	-	-	-	-	E27	0,6
127402	Grigio/Grey	HE 75W/FBT 15W	-	-	-	-	-	E27	0,6

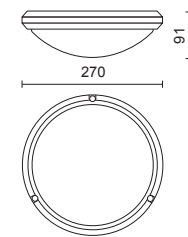

160917

Staffa 45.T in termoplastico nero
Black thermoplastic bracket 45.T

CE IP65 IK10

270TP



Codice Code	Colore Colour	Lampada Lamp	Watt	Colour T (K)	Attacco Base	Kg
126801	Nero/Black	F5Q incl.	18	3000	G24q-2	0,8
126600	Bianco/White	HE 40W/FBT 15W	-	-	E27	0,7
126601	Nero/Black	HE 40W/FBT 15W	-	-	E27	0,7

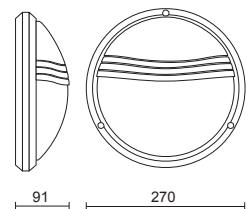

160917

Staffa 45.T in termoplastico nero
Black thermoplastic bracket 45.T

CE IP65 IK10

295T

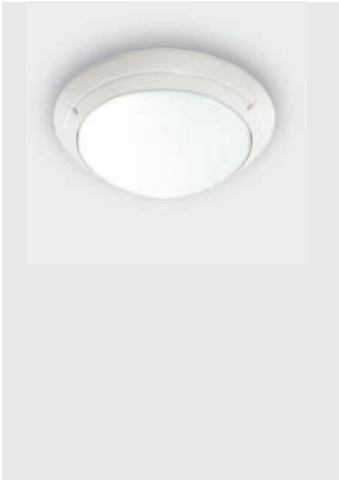

Codice Code	Colore Colour	Lampada Lamp	LED Lumen	Product Lumen	Watt	Colour T (K)	CRI	Attacco Base	Kg
128390	☐ Bianco/White	LED	1700	1190	11	3000	85	-	1,1
127890	☐ Bianco/White	F5Q	-	-	26	-	-	G24d-3	1,2
127490	☐ Bianco/White	HE 75W/FBT 15W	-	-	-	-	-	E27	0,7
127491	☐ Nero/Black	HE 75W/FBT 15W	-	-	-	-	-	E27	0,7
127492	☐ Grigio/Grey	HE 75W/FBT 15W	-	-	-	-	-	E27	0,7

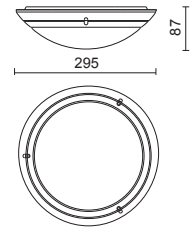

CE IP65 IK08

295TP

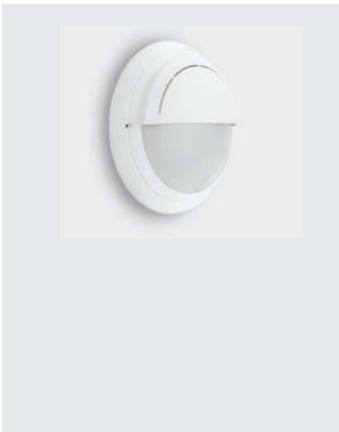

Codice Code	Colore Colour	Lampada Lamp	Watt	Colour T (K)	Attacco Base	Kg
126690	☐ Bianco/White	HE 40W/FBT 15W	-	-	E27	0,8
126691	☐ Nero/Black	HE 40W/FBT 15W	-	-	E27	0,8

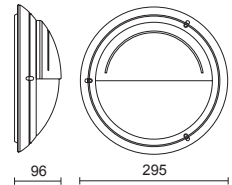

CE IP65 IK08

312T



Codice Code	Colore Colour	Lampada Lamp	LED Lumen	Product Lumen	Watt	Colour T (K)	CRI	Attacco Base	Ⓚ Kg
136510	☐ Bianco/White	LED	1700	1206	11	3000	85	-	1,5
136610	☐ Bianco/White	LED	2400	1702	18	3000	85	-	1,5
136210	☐ Bianco/White	F5Q incl.	-	-	26	3000	-	G24q-3	0,9
136211	☐ Nero/Black	F5Q incl.	-	-	26	3000	-	G24q-3	0,9
136010	☐ Bianco/White	HE 75W/FBT 21W	-	-	-	-	-	E27	0,8
136011	☐ Nero/Black	HE 75W/FBT 21W	-	-	-	-	-	E27	0,8
136012	☐ Metal/Silver	HE 75W/FBT 21W	-	-	-	-	-	E27	0,8

Con rilevatore di presenza
With motion detector

1365S10	☐ Bianco/White	LED	1700	1206	11	3000	85	-	1,6
---------	----------------	-----	------	------	----	------	----	---	-----

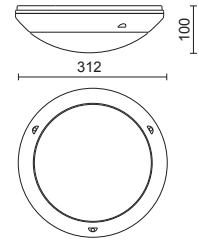

CE IP65 IK10

340T

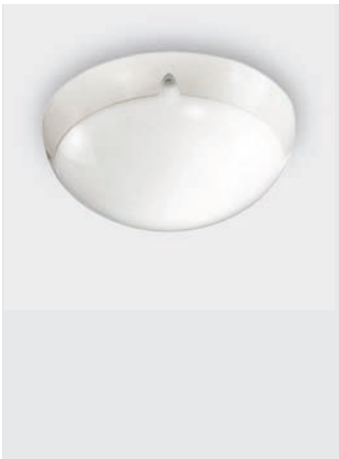

135000	☐ Bianco/White	LED	1700	1155	11	3000	85	-	1,5
135500	☐ Bianco/White	LED	2400	1630	18	3000	85	-	1,5
135600	☐ Bianco/White	LED	2950	2004	21	3000	85	-	1,5
134400	☐ Bianco/White	F5Q	-	-	2x18	-	-	G24d-2	1,9
134200	☐ Bianco/White	F5Q	-	-	1x26	-	-	G24d-3	1,5
134000	☐ Bianco/White	HE 100W/FBT 21W	-	-	-	-	-	E27	1,0
134001	☐ Nero/Black	HE 100W/FBT 21W	-	-	-	-	-	E27	1,0
134002	☐ Metal/Silver	HE 100W/FBT 21W	-	-	-	-	-	E27	1,0

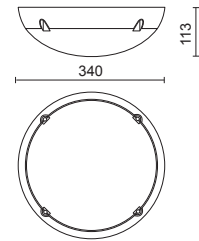

CE IP66 IK10

380T



Codice Code	Colore Colour	Lampada Lamp	LED Lumen	Product Lumen	Watt	Colour T (K)	CRI	Attacco Base	Ⓢ Kg
142300	☐ Bianco/White	LED	2400	1702	18	3000	85	-	2,7
142200	☐ Bianco/White	LED	3400	2411	26	3000	85	-	2,3
143400	☐ Bianco/White	F5Q incl.	-	-	2x26	3000	-	G24q-3	1,5
143401	☐ Nero/Black	F5Q incl.	-	-	2x26	3000	-	G24q-3	1,5
143600	☐ Bianco/White	FSMH incl.	-	-	1x57W	3000	-	GX24q-5	1,5
143601	☐ Nero/Black	FSMH incl.	-	-	1x57W	3000	-	GX24q-5	1,5
142000	☐ Bianco/White	HE 100W/FBT 21W	-	-	-	-	-	E27	1,2
142002	☐ Metal/Silver	HE 100W/FBT 21W	-	-	-	-	-	E27	1,2

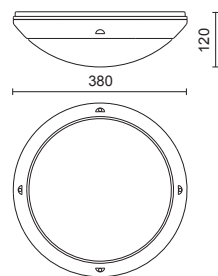

Con rilevatore di presenza
With motion detector

1423S00	☐ Bianco/White	LED	2400	1702	18	3000	85	-	2,6
---------	----------------	-----	------	------	----	------	----	---	-----

Emergenza 3h
Emergency 3h

142600	☐ Bianco/White	LED	2400	1702	18	3000	85	-	2,7
--------	----------------	-----	------	------	----	------	----	---	-----

CE IP65 IK10

430T



141600	☐ Bianco/White	LED	2400	1702	18	3000	85	-	2,8
141700	☐ Bianco/White	LED	3400	2411	26	3000	85	-	2,8
141000	☐ Bianco/White	F5Q incl.	-	-	2x26	3000	-	G24q-3	1,8
140400	☐ Bianco/White	F5Q	-	-	2x26	-	-	G24q-3	3,0
140100	☐ Bianco/White	HE	-	-	2xmax75	-	-	E27	1,7
140101	☐ Nero/Black	HE	-	-	2xmax75	-	-	E27	1,7
140300	☐ Bianco/White	FSMH incl. Su richiesta	-	-	70	3000	-	GX24q-6	1,7

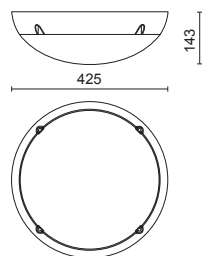

Emergenza 3h (su richiesta)
Emergency 3h (on demand)

141800	☐ Bianco/White	LED	2400	1702	18	3000	85	-	2,8
--------	----------------	-----	------	------	----	------	----	---	-----

CE IP66 IK10





270



Codice Code	Colore Colour	Lampada Lamp	Attacco Base	 Kg
127300	Bianco/White	HE 60W/ FBT 11W	E27	0,4
127301	Nero/Black	HE 60W/ FBT 11W	E27	0,4
127302	Grigio/Grey	HE 60W/ FBT 11W	E27	0,4

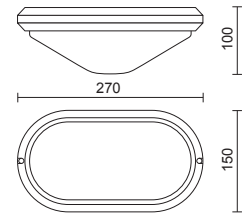

160909

Staffa 45.2 in termoplastico nero
Black thermoplastic bracket 45.2







 IP65 IK10

270P

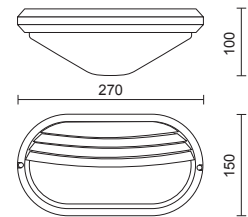

127000	Bianco/White	HE 40W/ FBT 11W	E27	0,5
127001	Nero/Black	HE 40W/ FBT 11W	E27	0,5
127002	Grigio/Grey	HE 40W/ FBT 11W	E27	0,5







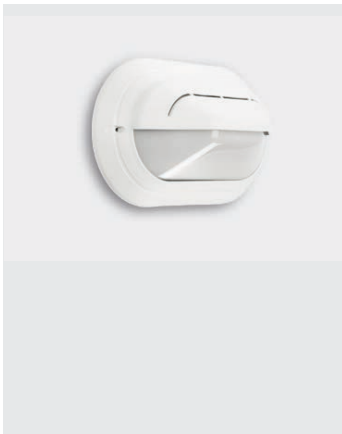

 IP65 IK10

295P

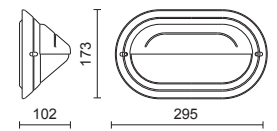

Codice Code	Colore Colour	Lampada Lamp	Attacco Base	⚖️ Kg
127090	Bianco/White	HE 40W/ FBT 11W	E27	0,5
127091	Nero/Black	HE 40W/ FBT 11W	E27	0,5



CE IP65 IK08

330



133400	Bianco/White	HE 75W/ FBT 15W	E27	0,6
133401	Nero/Black	HE 75W/ FBT 15W	E27	0,6

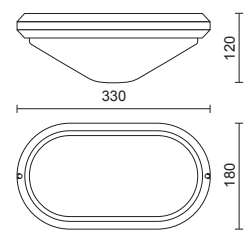

160915

Staffa 45.3 in termoplastico nero
Black thermoplastic bracket 45.3

CE IP65 IK10

Sfere

Le **sfere**, realizzate in metacrilato PMMA iniettato e poi soffiato, garantiscono: resistenza meccanica agli urti, trasparenza, brillantezza, ottima trasmissione della luce, inalterabilità agli agenti atmosferici e ai raggi UV.

The PMMA methacrylate **globes**, injection molded and blown, grant: high shock resistance, transparency, brightness, high UV stability and an optimal light diffusion.

SFERE SENZA ADATTATORI GLOBES WITHOUT ADAPTERS



Diametro Diameter	Codice Code			d1/d2	 Kg
	Chiara Clear	Opale Opal	Fumé Smoked		
ø 200	1000201	1000202	1000203	92/99	0,33
ø 250	1000251	1000252	1000253	110/118	0,62
ø 300	1000301	1000302	1000303	120/139	0,92
ø 400	1000401	1000402	1000403	165/178	1,30
ø 500	1000501	1000502	-	180/189	2,20

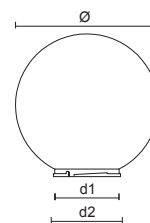

SFERE CON ADATTATORI E27 GLOBES WITH E27 ADAPTERS



ø 200	1010-201	1010-202	1010-203	-	0,46
ø 250	1010-251	1010-252	1010-253	-	0,75
ø 300	1010-301	1010-302	1010-303	-	1,05
ø 400	1010-461	1010-462	1010-463	-	1,56

Adattatori in tecnopolimero nero, caricato F.V. 30%, bucciato fine
Adapters in black technopolymer reinforced F.G. 30%, fine orange-peel finish

     IP44 IK08

**CON ATTACCO E27
WITH E27 ADAPTER**

Codice Code	Sfera Globe	Lampada Lamp	Attacco Base	d/h	 Kg
In tecnopolimero nero, caricato F.V. 30%, bucciato fine In black technopolymer reinforced F.G. 30%, fine orange-peel finish					
1010-20	∅ 200	HE 40W/FBT 15W	E27	105/63	0,1
1010-25	∅ 250	HE 100W/FBT 27W	E27	125/63	0,1
1010-30	∅ 300	HE 150W/FBT 27W	E27	145/68	0,2
1010-46	∅ 400	HE 150W/FBT 33W	E27	185/130	0,2

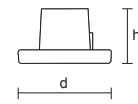





 IP44 IK08

**CON UNITÀ ELETTRICA
WITH CONTROL GEAR**

In tecnopolimero nero, caricato F.V. 30%, bucciato fine In black technopolymer reinforced F.G. 30%, fine orange-peel finish					
1010-43	∅ 400	QE 125W*	E27	-	2,1
1010-44	∅ 400	SE 70W	E27	-	2,3
1010-53	∅ 500	QE 125W*	E27	-	2,1

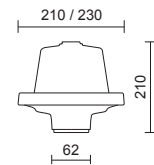

160924

Frangiluce
Refractor

*Utilizzare sempre il frangiluce (cod.160924)
*Refractor use compulsory (code 160924)





 IP66 IK08

**SENZA UNITÀ ELETTRICA
WITHOUT CONTROL GEAR**

In tecnopolimero nero, caricato F.V. 30%, bucciato fine In black technopolymer reinforced F.G. 30%, fine orange-peel finish					
1010-40	∅ 400	HE 100W-150W*/FBT 27W	E27	-	0,8
1010-50	∅ 500	HE 100W-150W*/FBT 27W	E27	-	0,8

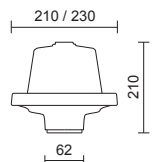

160924

Frangiluce
Refractor

*Utilizzare sempre il frangiluce (cod.160924)
*Refractor use compulsory (code 160924)





 $\neq 850^\circ$ IP66 IK08

BASE 19

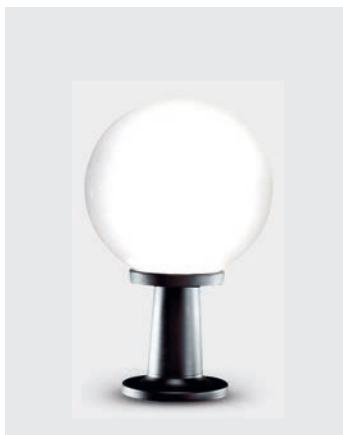

Codice Code	Colori Colours	Lampada Lamp	Attacco Base	 Kg
Braccio in termoplastico nero caricato F.V. Bracket in black thermoplastic reinforced F.G.				
119254	Bianco - Sfera opale White - Opal globe	HE 100W/ FBT 23W	E27	0,7
119251	Nero - Sfera opale Black - Opal globe	HE 100W/ FBT 23W	E27	0,7

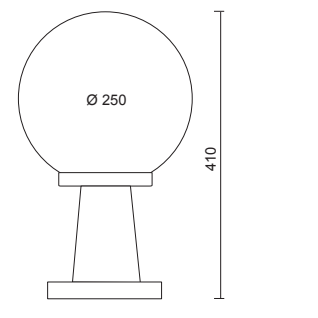

CE     IP44

APPLIQUE 20



Codice Code	Colori Colours	Lampada Lamp	Attacco Base	 Kg
Braccio in termoplastico nero caricato F.V. Bracket in black thermoplastic reinforced F.G.				
1200-21	Bianco - Sfera opale White - Opal globe	HE 60W/ FBT 15W	E27	0,5
1200-24	Nero - Sfera opale Black - Opal globe	HE 60W/ FBT 15W	E27	0,5

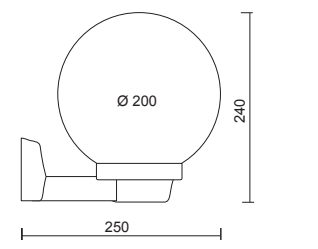





CE     IP43

APPLIQUE 25

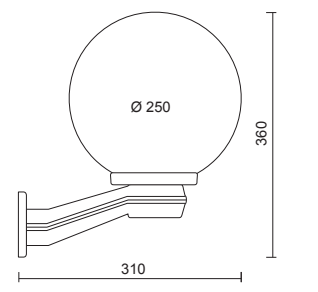

Codice Code	Colori Colours	Lampada Lamp	Attacco Base	 Kg
Braccio in termoplastico nero caricato F.V. Bracket in black thermoplastic reinforced F.G.				
125254	Nero - Sfera opale Black - Opal globe	HE 100W/ FBT 23W	E27	0,9



	125001	Braccio applique 25. Può portare anche la sfera Ø 300mm con il suo adattatore. Wall bracket range 25. It can also hold a Ø 300mm globe with its adapter.
	160901	Testa palo 1 Head pole 1
	160902	Testa palo 2 Head pole 2

CE     IP44



125001+160902

125001+160901

BASE TONDA E TAPPO ROUND BASE AND CAP



Codice
Code

Base in termoplastico caricato F.V. 30%, per palo Ø 60mm
Base in thermoplastic reinforced with F.G. 30% for Ø 60mm pole

160900

Tappo di chiusura in termoplastico caricato F.V. 30% per palo Ø 60mm
Closing cap in thermoplastic reinforced with F.G. 30% for pole Ø 60mm

94-10655-30

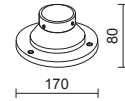

PALI RETTANGOLARI RECTANGULAR POLES



Palo in alluminio estruso bucciato nero, h. 1000mm
Pole in black extruded aluminium, orange-peel finish h. 1000mm

160101

BASE RETTANGOLARE E TAPPO RECTANGULAR BASE AND CAP



Base in termoplastico caricato F.V., per palo rettangolare
Base in thermoplastic reinforced with F.G. for rectangular pole

160918

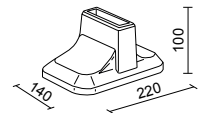

Indice Numerico
Numerical Index

Cod	Name	Pag
1000201	Sfere/Globes	324
1000202	Sfere/Globes	324
1000203	Sfere/Globes	324
1000251	Sfere/Globes	324
1000252	Sfere/Globes	324
1000253	Sfere/Globes	324
1000301	Sfere/Globes	324
1000302	Sfere/Globes	324
1000303	Sfere/Globes	324
1000401	Sfere/Globes	324
1000402	Sfere/Globes	324
1000403	Sfere/Globes	324
1000501	Sfere/Globes	324
1000502	Sfere/Globes	324
1010-20	Accessori	326
1010-201	Sfere/Globes	324
1010-202	Sfere/Globes	324
1010-203	Sfere/Globes	324
1010-25	Accessori	325
1010-251	Sfere/Globes	324
1010-252	Sfere/Globes	324
1010-253	Sfere/Globes	324
1010-30	Accessori	325
1010-301	Sfere/Globes	324
1010-302	Sfere/Globes	324
1010-303	Sfere/Globes	324
1010-40	Accessori	325
1010-43	Accessori	325
1010-44	Accessori	325
1010-46	Accessori	325
1010-461	Sfere/Globes	324
1010-462	Sfere/Globes	324
1010-463	Sfere/Globes	324
1010-50	Accessori	325
1010-53	Accessori	325
10231243	Miniten	265
10531243	Miniten	265
1071RW03	Balti 320	255
1071RW04	Balti 320	255
1073RW03	Balti 320	255
1073RW04	Balti 320	255
1081RW03	Balti 260	254
1081RW04	Balti 260	254
1084RW03	Balti 260	254
1084RW04	Balti 260	254
10910130	Maxilito Power	241
10910185	Maxilito Power	241
111801	Dedo 100	231
111802	Dedo 100	231
11200030	Lito	237
11200085	Lito	237
11220230	Lito Base	237
11220285	Lito Base	237
11430030	Lito 230	236
11430067	Lito 230	236
11430085	Lito 230	236
1145A1130	Maxilito	241
11451130	Maxilito	241
1145A1185	Maxilito	241
11451185	Maxilito	241
1146A1130	Maxilito	241
11461130	Maxilito	241
1146A1185	Maxilito	241
11461185	Maxilito	241
118303	Balti 150	252
118304	Balti 150	252

Cod	Name	Pag
118503	Balti 150	252
118504	Balti 150	252
119251	Base 19	326
119254	Base 19	326
119303	Balti 80	251
119304	Balti 80	251
119603	Balti 220	253
119604	Balti 220	253
119703	Balti 220	253
119704	Balti 220	253
119803	Balti 220	253
119804	Balti 220	253
1200-21	Applique 20	326
1200-24	Applique 20	326
125001	Accessori	326
125254	Applique 25	326
126600	270 TP	317
126601	270 TP	317
126690	295 TP	318
126691	295 TP	318
126801	270 TP	317
127000	270 P	322
127001	270 P	322
127002	270 P	322
127090	295 P	323
127091	295 P	323
127300	270	322
127301	270	322
127302	270	322
127400	270 T	317
127401	270 T	317
127402	270 T	317
127490	295 T	318
127491	295 T	318
127492	295 T	318
127601	270 T	317
127890	295 T	318
128300	270 T	317
128390	295 T	318
133400	330	323
133401	330	323
134000	340 T	319
134001	340 T	319
134002	340 T	319
134200	340 T	319
134400	340 T	319
135000	340 T	319
135500	340 T	319
135600	340 T	319
136010	312 T	319
136011	312 T	319
136012	312 T	319
136210	312 T	319
136211	312 T	319
1365S10	312 T	319
136510	312 T	319
136610	312 T	319
137000	250 T	317
137001	250 T	317
137400	250 T	317
138001	PN 210	274
138003	PN 210	274
138004	PN 210	274
139001	PN 280	275
139003	PN 280	275
139004	PN 280	275

Cod	Name	Pag
139201	PN 280	275
139203	PN 280	275
139204	PN 280	275
140100	430 T	320
140101	430 T	320
140300	430 T	320
140400	430 T	320
141000	430 T	320
141600	430 T	320
141700	430 T	320
141800	430 T	320
142000	380 T	320
142002	380 T	320
142200	380 T	320
1423S00	380 T	320
142300	380 T	320
142600	380 T	320
143400	380 T	320
143401	380 T	320
143600	380 T	320
143601	380 T	320
144001	PN 230	273
144003	PN 230	273
144004	PN 230	273
144501	PN 180	272
144503	PN 180	272
144504	PN 180	272
144701	PN 110 T	274
144703	PN 110 T	274
144704	PN 110 T	274
144767	PN 110 T	274
144801	PN 110 Q Applique	263
144801	PN 110 Q	272
144801	PN 110 Q Bollard	289
144803	PN 110 Q	272
144804	PN 110 Q Applique	263
144804	PN 110 Q	272
144804	PN 110 Q Bollard	289
144867	PN 110 Q Applique	263
144867	PN 110 Q	272
144867	PN 110 Q Bollard	289
147000	Achille 450 LED	308
147900	Achille 320 LED	306
148000	Achille 320 LED	306
148400	Achille 320	307
148500	Achille 320	307
149401	Achille 190 LED	305
149501	Achille 190 LED	305
150000	Serie 500	313
150001	Serie 500	313
150002	Serie 500	313
150300	Serie 500	313
150301	Serie 500	313
150400	Serie 500	313
150401	Serie 500	313
150402	Serie 500	313
1513180	Stilled	311
1523180	Nauto	301
1526480	Nauto	301
1533180	Stillens	311
1543180	Nauto	301
1546480	Nauto	301
155100	Walker	303
155180	Walker	303
155280	Walker	303
1553181	Walker LED	303



Indice Numerico
Numerical Index

Cod	Name	Pag	Cod	Name	Pag	Cod	Name	Pag
1557100	Nauto 230	300	2055-10	Incassi DECO	148	28-3140-51	Accessori	332
1557200	Nauto 230	300	2056-10	Incassi DECO	148	28-3141-31	Accessori	332
1558100	Nauto 230	300	2057-10	Incassi DECO	149	28-3142-51	Accessori	332
1558200	Nauto 230	300	2058-10	Incassi DECO	149	28-3403	Accessori	140
1563180	Nauto	300	209-510	RA 18 Dixit LED	143	28-3868-31	Accessori	332
1573120	Walled	312	209-531	RA 18 Dixit LED	143	28-3868-51	Accessori	332
1583180	Stilled	311	209-541	RA 18 Dixit LED	143	28-3869-51	Accessori	332
1593120	Walled	312	233-239AN	RA 8 Dixit LED range	124	28-3901-51	Accessori	332
160101	Accessori	327	233-239BN	RA 8 Dixit LED range	124	28-3902-51	Accessori	332
160348	Accessori	306-307	233-250AN	RA 8 Dixit LED range	124	28-3903-31	Accessori	332
160349	Accessori	308	233-250BN	RA 8 Dixit LED range	124	28-3903-51	Accessori	332
160700	Accessori	293	234-239BN	RA 8 Dixit LED range	125	28-3905-47	Accessori	332
160821	Accessori	332	234-259BN	RA 8 Dixit LED range	125	28-3955-16	Accessori	285
160900	Accessori	327	235-250B	RA 8 Dixit LED range	129	28-3955-67	Accessori	285
160901	Accessori	326	237-239BN	RA 8 Dixit LED range	123	28-3957-30	Accessori	333
160902	Accessori	326	237-250BN	RA 8 Dixit LED range	123	28-3958-32	Accessori	333
160909	Accessori	322	238-039BN	RA 8 Dixit LED range	127	28-3958-58	Accessori	333
160915	Accessori	323	238-239AN	RA 8 Dixit LED range	122	28-3959-30	Accessori	333
160917	Accessori	317	238-239BN	RA 8 Dixit LED range	122	28-3979-100	Accessori	333
160918	Accessori	327	238-250AN	RA 8 Dixit LED range	122	28-4019-30	Accessori	333
160924	Accessori	325	238-250BN	RA 8 Dixit LED range	122	28-4022-30	Accessori	333
160965	Accessori	303	239-239AN	RA 8 Dixit LED range	128	28-9001-51	Accessori	333
160976	Accessori	183	239-239BN	RA 8 Dixit LED range	128	28-9002-51	Accessori	333
1631701	PN 110 Q Bollard	289	239-250AN	RA 8 Dixit LED range	128	28-9003-51	Accessori	333
1631767	PN 110 Q Bollard	289	239-250BN	RA 8 Dixit LED range	128	28-9004-30	Accessori	333
1632701	PN 110 Q Bollard	289	2400-10-31	DJ	146	28-9005-30	Accessori	333
1632767	PN 110 Q Bollard	289	2400-10-64	DJ	146	28-9006-32	Accessori	333
1635004	Bidi Applique	261	2400-31	DJ	146	3735-01	Giada	207
1635067	Bidi Applique	261	243-250AN	RA 14 Dixit LED	140	3740-01	Giada	207
1635101	PN 110 Q Applique	263	243-250BN	RA 14 Dixit LED	140	3741-01	Giada 200	207
1635101	PN 110 Q Bollard	289	243-259BN	RA 14 Dixit LED	140	3743-01	Giada 200	207
1635104	PN 110 Q Applique	263	243-25E2	RA 14 Dixit LED	140	3748-01	AP Line	211
1635104	PN 110 Q Bollard	289	244-242AN	RA 20 Dixit LED	144	3762-B-150	Beta	213
1635167	PN 110 Q Applique	263	244-242BN	RA 20 Dixit LED	144	3762-C-150	Crio	213
1635167	PN 110 Q Bollard	289	244-242WBN	RA 20 WW Dixit LED	144	3772-21-90	Quadro	212
1636401	Bidi Bollard	285	244-24E2	RA 20 Dixit LED	144	3776-21-90	Quadro	212
1636467	Bidi Bollard	285	248-230AN	RA 17 Dixit LED	142	3803-01	San 35 LED	195
1636801	Bidi Bollard	285	248-230BN	RA 17 Dixit LED	142	3804-01	San 35 LED	195
1636867	Bidi Bollard	285	248-240AN	RA 17 Dixit LED	142	3824-01	PF 9	190
173RM3120	Dino	229	248-240BN	RA 17 Dixit LED	142	3825-01	PF 15	190
173RM3130	Dino	229	249-200AN	RA 23 S Dixit LED	145	3830-01	PF 22	191
173RS3120	Dino	229	249-200BN	RA 23 S Dixit LED	145	3831-01	PF 22	191
173RS3130	Dino	229	249-210AN	RA 23 S Dixit LED	145	3875-01	PF 10	192
173S03120	Dino	229	249-210BN	RA 23 S Dixit LED	145	3880-01	PF 19	192
173S03130	Dino	229	249-240AN	RA 23 SP Dixit LED	145	3881-01	PF 19	192
1803120	Turks	291	249-240BN	RA 23 SP Dixit LED	145	3887-01	PF 30	193
1803130	Turks	291	249-250AN	RA 23 SP Dixit LED	145	3888-02	PF 30	193
1813120	Turks	291	249-250BN	RA 23 SP Dixit LED	145	3890-02	Sofi 301	177
1813130	Turks	291	250-220AN	RA 16	141	3894-01	PF Line	191
1851A03	TB 300	277	250-220BN	RA 16	141	3915-01	Floot	175
185103	TB 300	277	251-200	RA 7	147	3916-01	Floot	175
1851A04	TB 300	277	252-200	RA 4	117	3920-01	Iconica	173
185104	TB 300	277	252-210	RA 4	117	3921-01	Iconica	173
1887A03	TB 420	277	253-210	RA 4	117	406-011	Aplomb 350 LED	179
188703	TB 420	277	255-200AN	RA 11 Dixit LED range	134	430-111	Zeppel 400	183
1887A04	TB 420	277	255-200BN	RA 11 Dixit LED range	134	433-111	Zeppel 400	183
188704	TB 420	277	256-200AN	RA 11 Dixit LED range	138	439-011	Zeppel 400	183
190311	Caicos	293	256-200BN	RA 11 Dixit LED range	138	450-361	Boma	77
190501	Bidi Bollard	285	257-200BN	RA 11 Dixit LED range	136	453-120	Boma LED	197
190567	Bidi Bollard	285	257-209BN	RA 11 Dixit LED range	136	453-160	Boma LED	77
190601	Bidi Bollard	285	258-200BN	RA 11 Dixit LED range	137	453-210	Boma LED-S	181
190604	Bidi Applique	261	258-209BN	RA 11 Dixit LED range	137	453-260	Boma LED	77
190667	Bidi Applique	261	259-200AN	RA 11 Dixit LED range	135	506-221	Minicyclos-KP	203
190667	Bidi Bollard	285	259-200BN	RA 11 Dixit LED range	135	508-211AN	Kardan-IN	156
190704	Bidi Applique	261	28-0219-79	Accessori	300-301	508-211BN	Kardan-IN	156
190767	Bidi Applique	261	28-3138-51	Accessori	332	508-221AN	Kardan-IN	156



Indice Numerico
Numerical Index

Cod	Name	Pag
508-221BN	Kardan-IN	156
509-211AN	Kardan-TL	156
509-211BN	Kardan-TL	156
509-221AN	Kardan-TL	156
509-221BN	Kardan-TL	156
528-511AN	Kyclos-TL	161
528-511BN	Kyclos-TL	161
528-521AN	Kyclos-TL	161
528-521BN	Kyclos-TL	161
529-311AN	Minikyclos-IN	159
529-311BN	Minikyclos-IN	159
529-321AN	Minikyclos-IN	159
529-321BN	Minikyclos-IN	159
6123-07	Spot B.T.	79
6123-10	Spot B.T.	79
6123-20	Spot B.T.	79
6124-10	Spot B.T.	79
6501-10	Binari ELV/ELV Tracks	99
6501-20	Binari ELV/ELV Tracks	99
6501-30	Binari ELV/ELV Tracks	99
6601-00	Accessori	99
6602-00	Accessori	99
6603-00	Accessori	99
6604-00	Accessori	99
6605-00	Accessori	99
6606-00	Accessori	99
6607-20	Accessori	99
6610-00	Accessori	99
6619-10	Accessori	99
6620-00	Accessori	99
6620-10	Accessori	99
6623-00	Accessori	99
6624-00	Accessori	99
6650-03	Accessori	99
712-016	Ayr	78
713-016	Ayr	78
717-161	Minikyclos	59
717-161A	Minikyclos	59
717-261	Minikyclos	59
717-261A	Minikyclos	59
717-321A	Minikyclos	59
717-329	Minikyclos	59
717-361A	Minikyclos	59
717-369	Minikyclos	59
717-621	Minikyclos 230	58
717-621A	Minikyclos 230	58
717-651	Minikyclos 230	58
717-661	Minikyclos 230	58
717-661A	Minikyclos 230	58
719-221	Kyclos Power	65
719-261	Kyclos Power	65
720-016	Flex	78
725-562	Kyclos	64
725-663	Kyclos	64
725-861	Kyclos	64
738-016	Drim	73
738-020	Drim	73
738-035	Drim	73
738-610	Drim LED	72
738-710	Drim LED	72
738-810	Drim LED 230	71
738-820	Drim LED 230	71
738-910	Drim LED 230	71
738-920	Drim LED 230	71
740-035	Drim	73
742-121	Perfetto 230	52

Cod	Name	Pag
742-121A	Perfetto 230	52
742-161	Perfetto 230	52
742-161A	Perfetto 230	52
742-261	Perfetto 230	52
742-261A	Perfetto 230	52
743-161	Perfetto	53
743-161A	Perfetto	53
743-269	Perfetto	53
743-461	Perfetto	53
743-461A	Perfetto	53
745-161	Perfetto Broadway	111
745-161A	Perfetto Broadway	111
745-361	Perfetto Broadway	111
745-361A	Perfetto Broadway	111
747-469	Perfetto	53
748-029	Miniperfetto	45
748-111A	Miniperfetto-S	169
748-119	Miniperfetto-S	169
748-129	Miniperfetto	45
748-151A	Miniperfetto	44
748-159	Miniperfetto	44
748-161A	Miniperfetto	44
748-169	Miniperfetto	44
749-261	Miniperfetto Broadway	110
749-261A	Miniperfetto Broadway	110
750-271AN	Miniperfetto	45
750-271BN	Miniperfetto	45
7501-10	Binari LKM tondo LKM round Tracks	90
7501-20	Binari LKM tondo LKM round Tracks	90
7501-30	Binari LKM tondo LKM round Tracks	90
7501-40	Binari LKM tondo LKM round Tracks	90
751-221	Perfetto Compact	51
751-221A	Perfetto Compact	51
751-261	Perfetto Compact	51
751-261A	Perfetto Compact	51
7511-10	Binari LKM quadro LKM square Tracks	92
7511-20	Binari LKM quadro LKM square Tracks	92
7511-30	Binari LKM quadro LKM square Tracks	92
7511-40	Binari LKM quadro LKM square Tracks	92
7512-10	Binari LKM incasso LKM recessed Tracks	94
7512-20	Binari LKM incasso LKM recessed Tracks	94
7512-30	Binari LKM incasso LKM recessed Tracks	94
7512-40	Binari LKM incasso LKM recessed Tracks	94
7520-10	Binari DKM/DKM tracks	86
7520-20	Binari DKM/DKM tracks	86
7520-30	Binari DKM/DKM tracks	86
7520-40	Binari DKM/DKM tracks	86
7559-00	Accessori	86
7600-00	Accessori	90
7601-00-W	Accessori	90
7602-10-W	Accessori	90
7602-11-W	Accessori	90
7603-10-W	Accessori	90
7604-10-W	Accessori	95
7604Q-10-W	Accessori	87
7604T-10-W	Accessori	91
7605-10-W	Accessori	90
7605-11-W	Accessori	90

Cod	Name	Pag
7606-00	Accessori	87
7606-04-00	Accessori	87
7606-05	Accessori	87
7606-06	Accessori	87
7607-00-00	Accessori	87
7609-00-00	Accessori	87
7610-10-W	Accessori	90
7617-00	Accessori	91
7618-00	Accessori	91
7619-10-W	Accessori	91
7621-10-W	Accessori	90
7621-11-W	Accessori	90
7622-10-W	Accessori	90
7623-00-W	Accessori	91
7624-00	Accessori	91
7625-00	Accessori	91
7626-00-00	Accessori	91
7651-10-W	Accessori	86
7651-11-W	Accessori	86
7652-10-W	Accessori	92
7652-11-W	Accessori	92
7653-10-W	Accessori	92
7654-10-W	Accessori	93
7655-10-W	Accessori	86
7655-11-W	Accessori	86
7656-10-W	Accessori	86
7656-11-W	Accessori	86
7657-10-W	Accessori	86
7658-10-W	Accessori	86
7659-00-W	Accessori	87
76591-00-W	Accessori	95
7660-00-W	Accessori	87
7661-10-W	Accessori	86
7662-10-W	Accessori	95
7662-11-W	Accessori	95
7663-10-W	Accessori	95
7664-00-48	Accessori	95
7701-10	Binari MM/MM Tracks	97
7701-15	Binari MM/MM Tracks	97
7701-20	Binari MM/MM Tracks	97
7701-30	Binari MM/MM Tracks	97
7800-00	Accessori	97
7802-00-W	Accessori	97
7803-00-W	Accessori	97
7804-00-W	Accessori	97
7805-00-W	Accessori	97
7806-00	Accessori	97
7807-02-W	Accessori	97
7810-00-W	Accessori	97
7819-00-W	Accessori	97
7823-00-W	Accessori	97
7825-00	Accessori	97
7841-13	Broadway	108
7841-23	Broadway	108
7842-13	Broadway	108
7842-23	Broadway	108
7850-00	Broadway	108
7850E-00	Broadway	108
7850I-00	Broadway	108
7851-00-00	Broadway	108
791-311	Merlino 110 LED	69
791-411	Merlino 110 LED	69
81-04002	Driver	334
81-04003	Driver	334
81-04004	Driver	334
81-04005	Driver	334



Indice Numerico
Numerical Index

Cod	Name	Pag
81-04006	Driver	334
81-04007	Driver	334
81-04008	Driver	334
81-04009	Driver	334
81-04010	Driver	334
81-04011	Driver	334
81-04012	Driver	334
81-04013	Driver	334
81-04014	Driver	334
81-04015	Driver	334
81-04016	Driver	334
81-04017	Driver	335
81-04018	Driver	335
81-04019	Driver	335
81-04020	Driver	335
81-04021	Driver	335
81-04022	Driver	335
84108	Accessori	333
84-90380-51	Accessori	219
84-90390-51	Accessori	219
84-90400-51	Accessori	219
91-90032	Driver	335
91-90039	Driver	335
93-9WA-0715F	Stripled	109-221
93-9WA-1330F	Stripled	221
93-9WA-1390F	Stripled	221
93-9WB-0715F	Stripled	109-221
93-9WB-1330F	Stripled	221
93-9WB-1390F	Stripled	221
93-WA15-0320-10	Bender	223
93-WB15-0320-10	Bender	223
94-10655-30	Accessori	327
98-13380-61	Accessori	140
K7382-S04	Profilo 38 Surface	219
K7392-R04	Profilo 39 Recessed	219
K7402-C04	Profilo 40 Corner	219















Indice Alfanumerico
Alphanumerical Index

Name	Pag
270	322
330	323
250 T	317
270 P	322
270 T	317
270 TP	317
295 P	323
295 T	318
295 TP	318
312 T	319
340 T	319
380 T	320
430 T	320
Accessori	332
Achille 190 LED	305
Achille 320	307
Achille 320 LED	306
Achille 450 LED	308
AP Line	211
Aplomb 350 LED	179
Applique 20	326
Applique 25	326
Ayr	78
Balti 80	251
Balti 150	252
Balti 220	253
Balti 260	254
Balti 320	255
Base 19	326
Bender Light	223
Beta	213
Bidi Applique	261
Bidi Bollard	285
Binari/Tracks DKM	86
Binari/Tracks ELV	99
Binari LKM incasso LKM recessed Tracks	94
Binari LKM quadro LKM square Tracks	92
Binari LKM tondo LKM round Tracks	90
Binari/Tracks MM	97
Boma	77
Boma LED	77
Boma LED-S	181
Broadway	108
Caicos	293
Crio	213
Dedo 100	231
Dino	229
DJ	146
Drim	73
Drim LED	72
Drim LED 230	71
Driver	334
Flex	78
Floot	175
Giada	207
Giada 200	207
Iconica	173
Incassi DECO	148
Kardan-IN	156
Kardan-TL	157
Kyclos	64
Kyclos Power	65
Kyclos-TL	161
Lito	237

Name	Pag
Lito 230	236
Maxilito	241
Maxilito Power	241
Merlino 110 LED	69
Minikyclos	59
Minikyclos 230	58
Minikyclos-IN	159
Minikyclos-KP	203
Miniperfetto	44
Miniperfetto Broadway	110
Miniperfetto-S	169
Miniten	265
Nauto 230	300
Perfetto	53
Perfetto 230	52
Perfetto Broadway	111
Perfetto Compact	51
PF 10	192
PF 15	190
PF 19	192
PF 22	191
PF 30	193
PF 9	190
PF Line	191
PN 110 Q	272
PN 110 Q Bollard	289
PN 110 T	274
PN 110 Q Applique	263
PN 180	272
PN 210	274
PN 230	273
PN 280	275
Profilo 38 Surface	219
Profilo 39 Recessed	219
Profilo 40 Corner	219
Quadro	212
RA 11 Dixit LED range	134
RA 14 Dixit LED	134
RA 16	141
RA 17 Dixit LED	142
RA 18 Dixit LED	143
RA 20 Dixit LED	144
RA 20 WW Dixit LED	144
RA 23 S Dixit LED	145
RA 23 SP Dixit LED	145
RA 4 range	117
RA 7	147
RA 8 Dixit LED range	122
San 35 LED	195
Serie 500	313
Sfere/Globes	324
Sofi 301	177
Spot B.T.	79
Stilled	311
Stillens	311
Stripled	109
TB 300	277
TB 420	277
Turks	291
Walker	303
Walker LED	303
Walled	312
Zeppel 400	183

















Indice accessori
Accessories index















Codice Code	Immagine	Descrizione Description	Applicabili su Suitable for
160821		Bobina di cavo di alimentazione H05RN-F 2x1mm ² , L 10mt 10mt supply cable coil H05RN-F 2x1mm ²	Dedo 100 - p 231 Walker - p 303 Turks - p 291 Achille 190 - p 305 Caicos - p 293 Stilled - p 311 Nauto 230 - p 300 Stillens - p 311 Nauto - p 301 Walker LED - p 303
28-3138-51		Ottica professionale W Professional optic device W	Perfetto 230 - p 52 Merlino 110 LED - p 69 Minikyclos-IN - p 159 Lito Base - p 237 Perfetto - p 53 Drim LED 230 - p 71 Kyclos-TL - p 161 Maxilito - p 241 Minikyclos 230 - p 58 Drim LED - p 72 Iconica - p 173 Maxilito Power - p 241 Minikyclos - p 59 Perfetto Broadway - p 111 Floot - p 175 Balti 320 - p 255 Kyclos - p 64 RA 11 - p 134/138 Dedo 100 - p 231 Achille 320 LED - p 306 Kyclos Power - p 65 RA 17 - p 142 Lito 230 - p 236 Achille 450 LED - p 308
28-3140-51		Ottica professionale S Professional optic device S	Perfetto 230 - p 52 Merlino 110 LED - p 69 Minikyclos-IN - p 159 Lito Base - p 237 Perfetto - p 53 Drim LED 230 - p 71 Kyclos-TL - p 161 Maxilito - p 241 Minikyclos 230 - p 58 Drim LED - p 72 Iconica - p 173 Maxilito Power - p 241 Minikyclos - p 59 Perfetto Broadway - p 111 Floot - p 175 Balti 320 - p 255 Kyclos - p 64 RA 11 - p 134/138 Dedo 100 - p 231 Achille 320 LED - p 306 Kyclos Power - p 65 RA 17 - p 142 Lito 230 - p 236 Achille 450 LED - p 308
28-3141-31		Ottica professionale XW Professional optic device XW	Perfetto 230 - p 52 Merlino 110 LED - p 69 Minikyclos-IN - p 159 Lito Base - p 237 Perfetto - p 53 Drim LED 230 - p 71 Kyclos-TL - p 161 Maxilito - p 241 Minikyclos 230 - p 58 Drim LED - p 72 Iconica - p 173 Maxilito Power - p 241 Minikyclos - p 59 Perfetto Broadway - p 111 Floot - p 175 Balti 320 - p 255 Kyclos - p 64 RA 11 - p 134/138 Dedo 100 - p 231 Achille 320 LED - p 306 Kyclos Power - p 65 RA 17 - p 142 Lito 230 - p 236 Achille 450 LED - p 308
28-3140-51		Ottica professionale S Professional optic device S	Perfetto 230 - p 52 Merlino 110 LED - p 69 Minikyclos-IN - p 159 Lito Base - p 237 Perfetto - p 53 Drim LED 230 - p 71 Kyclos-TL - p 161 Maxilito - p 241 Minikyclos 230 - p 58 Drim LED - p 72 Iconica - p 173 Maxilito Power - p 241 Minikyclos - p 59 Perfetto Broadway - p 111 Floot - p 175 Balti 320 - p 255 Kyclos - p 64 RA 11 - p 134/138 Dedo 100 - p 231 Achille 320 LED - p 306 Kyclos Power - p 65 RA 17 - p 142 Lito 230 - p 236 Achille 450 LED - p 308
28-3142-51		Ottica professionale M Professional optic device M	Perfetto 230 - p 52 Merlino 110 LED - p 69 Minikyclos-IN - p 159 Lito Base - p 237 Perfetto - p 53 Drim LED 230 - p 71 Kyclos-TL - p 161 Maxilito - p 241 Minikyclos 230 - p 58 Drim LED - p 72 Iconica - p 173 Maxilito Power - p 241 Minikyclos - p 59 Perfetto Broadway - p 111 Floot - p 175 Balti 320 - p 255 Kyclos - p 64 RA 11 - p 134/138 Dedo 100 - p 231 Achille 320 LED - p 306 Kyclos Power - p 65 RA 17 - p 142 Lito 230 - p 236 Achille 450 LED - p 308
28-3868-31		Ottica professionale XW Professional optic device XW	RA 8 - p 122-123-125-128-129 Balti 260 - p 254
28-3868-51		Ottica professionale W Professional optic device W	RA 8 - p 122-123-124-125-128-129 Balti 260 - p 254
28-3869-51		Ottica professionale M Professional optic device M	RA 8 - p 122-123-124-125-128-129 Balti 260 - p 254
28-3901-51		Ottica professionale S Professional optic device S	Miniperfetto - p 44-45 Miniperfetto Broadway - p 110 Kardan - p 156-157 Miniperfetto-S - p 169
28-3902-51		Ottica professionale M Professional optic device M	Miniperfetto - p 44-45 Perfetto Compact - p 51 Miniperfetto Broadway - p 110 RA 8 Q - p 124 Kardan - p 156-157 Miniperfetto-S - p 169
28-3903-31		Ottica professionale XW Professional optic device XW	Perfetto Compact - p 51 RA 8 Q - p 124
28-3903-51		Ottica professionale W Professional optic device W	Miniperfetto - p 44-45 Perfetto Compact - p 51 Miniperfetto Broadway - p 110 RA 8 Q - p 124 Kardan - p 156-157 Miniperfetto-S - p 169
28-3905-47		Schermo di chiusura in termoplastico trasparente Closing screen in clear thermoplastic material	Miniperfetto - p 44-45 Perfetto Compact - p 51 Miniperfetto Broadway - p 110 Kardan - p 156-157 Miniperfetto-S - p 169



Indice accessori
Accessories index









Codice Code	Immagine	Descrizione Description	Applicabili su Suitable for
28-3957-30		Cilindro antiabbagliamento Snoot	Perfetto 230 - p 52 Perfetto - p 53 Minikyclos 230 - p 58 Minikyclos - p 59 Kyclos - p 64 Kyclos Power - p 65 Drim LED 230 - p 71 Drim LED - p 72 Perfetto Broadway - p 111 Minikyclos-IN - p 159 Kyclos-TL - p 161 Iconica - p 173 Flood - p 175 Achille 320 LED - p 306 Achille 450 LED - p 308
28-3958-32		Vetro temprato con filtro food rosato Pink tempered glass for food application	Perfetto 230 - p 52 Perfetto - p 53 Minikyclos 230 - p 58 Minikyclos - p 59 Kyclos - p 64 Kyclos Power - p 65 Drim LED 230 - p 71 Drim LED - p 72 Perfetto Broadway - p 111 Minikyclos-IN - p 159 Kyclos-TL - p 161 Iconica - p 173 Flood - p 175
28-3958-58		Vetro temprato trasparente Clear tempered glass	Perfetto 230 - p 52 Perfetto - p 53 Minikyclos 230 - p 58 Minikyclos - p 59 Kyclos - p 64 Kyclos Power - p 65 Drim LED 230 - p 71 Drim LED - p 72 Perfetto Broadway - p 111 Minikyclos-IN - p 159 Kyclos-TL - p 161 Iconica - p 173 Flood - p 175
28-3959-30		Frangiluce alveolare Honeycomb	Perfetto 230 - p 52 Perfetto - p 53 Minikyclos 230 - p 58 Minikyclos - p 59 Kyclos - p 64 Kyclos Power - p 65 Drim LED 230 - p 71 Drim LED - p 72 Perfetto Broadway - p 111 Minikyclos-IN - p 159 Kyclos-TL - p 161 Iconica - p 173 Flood - p 175 Achille 320 LED - p 306 Achille 450 LED - p 308
28-3979-100		Cilindro antiabbagliamento dorato Golden snoot	Miniperfetto - p 44-45 Miniperfetto Broadway - p 110 Miniperfetto-S - p 169
28-4019-30		Frangiluce alveolare Honeycomb	RA 11 - p 134/138 Lito 230 - p 236 Lito Base - p 237 Maxilito - p 241 Maxilito Power - p 241 Balti 320 - p 255
28-4022-30		Frangiluce alveolare Honeycomb	Miniperfetto - p 44-45 Miniperfetto Broadway - p 110 Kardan - p 156-157 Miniperfetto-S - p 169
28-9001-51		Ottica professionale S Professional optic device S	Achille 190 LED - p 305
28-9002-51		Ottica professionale M Professional optic device M	Achille 190 LED - p 305
28-9003-51		Ottica professionale W Professional optic device W	Achille 190 LED - p 305
28-9004-30		Cilindro antiabbagliamento Snoot	Perfetto Compact - p 51
28-9005-30		Frangiluce alveolare Honeycomb	Perfetto Compact - p 51
28-9006-32		Vetro temprato con filtro food rosato Pink tempered glass for food application	Perfetto Compact - p 51
84108		Connettore stagno Rated cable connector	Dino - p 229 Dedo 100 - p 231 Lito 230 - p 236 Lito - p 237 Maxilito - p 241 Maxilito Power - p 241 Caicos - p 293 Nauto 230 - p 300 Nauto - p 301 Walker LED - p 303 Walker - p 303 Stilled - p 311 Stillens - p 311 Serie 500 - p 313

Indice driver
Drivers index

Codice Code		Descrizione Description	Applicabili su Suitable for		
81-04002		18 W Output 500mA - Dimmerabile DALI Dali dimmable	Miniperfetto - p 45 RA 11 - p 134/138		
81-04003		12 W Output 350mA - Dimmerabile DALI Dali dimmable	RA 8 - p 122/128		
81-04004		51 W Output 1400mA	RA 20 - p 144 RA 20 WW - p 144	RA 23 S/SP - p 145 Minikyclos-IN - p 145	Kyclos-TL - p 161
81-04005		10 W Tensione costante - Output 10VDC 10 W Constant voltage - Output 10VDC	Nauto - p 301 Walled - p 312		
81-04006		20 W Tensione costante - Output 24VDC 20 W Constant voltage - Output 24VDC	Nauto - p 301 Stilled - p 311	Walled - p 312	
81-04007		5,5 W Output 350mA - Regolabile sul taglio di fase Dimmable on the mains	RA 8 - p 122/128		
81-04008		8,5 W Output 500mA - Regolabile sul taglio di fase e 1-10V Dimmable on the mains and 1-10V	RA 8 - p 122/128		
81-04009		9 W Output 250mA	RA 8 - p 122/128		
81-04010		12 W Output 350mA - Regolabile sul taglio di fase Dimmable on the mains	RA 8 - p 122/128 RA 11 - p 134/138	Kardan - p 156/157	
81-04011		18 W Output 500mA	Miniperfetto - p 45 RA 11 - p 134/138	RA 16 - p 141 RA 23 S/SP - p 145	Kardan - p 156/157 Minikyclos-IN - p 159
81-04012		21 W Output 600mA	RA 11 - p 134/138 RA 14 - p 140	Kardan - p 156/157 Minikyclos-IN - p 159	
81-04013		33 W Output 900mA	RA 14 - p 140 RA 17 - p 142	RA 23 S/SP - p 145 Minikyclos-IN - p 159	Kyclos-TL - p 161
81-04014		38 W Output 1050mA - Dimmerabile DALI Dali dimmable	RA 14 - p 140		
81-04015		33 W Output 900mA	RA 17 - p 142		
81-04016		51 W Output 1400mA - Dimmerabile DALI Dali dimmable	RA 20 - p 144 RA 20 WW - p 144		



Indice driver
Drivers index

Codice Code		Descrizione Description	Applicabili su Suitable for
81-04017		43 W Output 1200mA	RA 23 S - p 145
81-04018		75 W Output 1400mA	RA 23 SP - p 145
81-04019		20 W Corrente costante - Output 500mA Constant current - Output 500mA	RA 4 - p 117 RA 7 - p 147
81-04020		15 W Corrente costante - Output 350mA Constant current - Output 350mA	DJ - p 146 Nauto - p 301 Stilled - p 311 Stillens - p 311
81-04021		2x18 W Output 2x500mA	Kardan - p 156/157
81-04022		21 W Output 600mA	RA11 - p 134-136-138
91-90032		150 W Tensione costante 24VDC 150 W 24VDC constant voltage	Stripled 24VDC - p 221 Bender Light - p 223
91-90039		50W Tensione costante 24VDC 24VDC constant voltage	Stripled Broadway - p 109

CONDIZIONI GENERALI DI VENDITA GENERAL SALE TERMS AND CONDITIONS

- Gli ordini si intendono accettati ai prezzi e alle condizioni di vendita in vigore. A fronte di eventuali variazioni di listino e quindi di prezzi e condizioni, l'acquirente avrà la facoltà di annullare gli ordini in atto con comunicazione scritta entro 8 giorni dalla nostra informazione di variazione. Gli ordini si intendono subordinati alla nostra accettazione.
- I prezzi di listino s'intendono franco nostri magazzini di fabbrica, salvo accordi speciali.
- Ogni nostra obbligazione cessa con la consegna della merce al vettore o allo spedizioniere. Il trasporto o la spedizione con qualsiasi mezzo s'intendono sempre effettuati a rischio e pericolo dell'acquirente, con esclusione di ogni nostra responsabilità in caso di rotture, avarie, furti o manomissioni.
- I termini di consegna, ove pattuiti, s'intendono sempre indicativi.
- L'azienda si riserva il diritto di apportare qualsiasi modifica alla propria produzione senza preavviso.
- E' vietata la riproduzione anche parziale di questo catalogo.
- IVELA S.p.A. garantisce i prodotti del seguente catalogo per un termine di 2 anni dalla data di acquisto purché installati correttamente e utilizzati nei limiti e in conformità alle specifiche tecniche dei componenti.
- In caso di contestazioni si stabilisce la competenza esclusiva dell'Autorità Giudiziaria di Milano.
- Purchase orders are considered accepted at the sale prices and conditions in force. In the event of variations to the price list such as pricing and sales terms and conditions, the purchaser shall have the right to cancel purchase orders placed. Such purchase order cancellation shall be in writing within eight days from date of receipt of notice of said variation. All purchase orders shall be considered accepted upon our confirmation.
- All prices quoted in the price list are ex works (carriage costs not included) unless otherwise agreed upon.
- We shall not be considered liable for the goods at the moment they are handed over to the carrier for shipment. Carriage or shipment of goods by whatever transport or shipping means shall be always considered at the risk and responsibility of the purchaser. We shall not be considered liable for breakages, faults, thefts or alterations to said goods.
- Delivery terms agreed upon are always to be considered indicative.
- We reserve the right to alter our products without prior notification.
- It is forbidden to reproduce any part of this catalogue.
- IVELA S.p.A. guarantees the products of the current catalogue for a 2 year period from the date of purchase, provided that the installation is correct, and that the products are used within the limits and in conformity with the technical features of their components.
- In case of disputes the competent judicial authorities shall be the Court of Milan.

Ivela si riserva la facoltà di modificare, in qualsiasi momento e senza preavviso, le caratteristiche tecniche dei modelli illustrati nel presente catalogo. I colori si intendono indicativi.

Ivela reserves the right to change, at any time and without prior warning, the technical specification of any product illustrated in this catalogue. Colours are simply indicative of the real nuance.

